

Architecture
and the
Built environment

#01
2017



Climate-responsive design

A framework for an energy concept design-decision support tool
for architects using principles of climate-responsive design

Remco Looman

Climate-responsive design

**A framework for an energy concept design-decision support tool
for architects using principles of climate-responsive design**

Remco Looman

*Delft University of Technology, Faculty of Architecture and the Built Environment,
Department of Architectural Engineering + Technology*



abe.tudelft.nl

Design: Sirene Ontwerpers, Rotterdam

ISBN 978-94-92516-36-7

ISSN 2212-3202

© 2017 Remco Looman

All rights reserved. No part of the material protected by this copyright notice may be reproduced or utilized in any form or by any means, electronic or mechanical, including photocopying, recording or by any information storage and retrieval system, without written permission from the author.

Unless otherwise specified, all the photographs in this thesis were taken by the author. For the use of illustrations effort has been made to ask permission for the legal owners as far as possible. We apologize for those cases in which we did not succeed. These legal owners are kindly requested to contact the publisher.

Climate-responsive design

A framework for an energy concept design-decision support tool for
architects using principles of climate-responsive design

Proefschrift

ter verkrijging van de graad van doctor
aan de Technische Universiteit Delft,
op gezag van de Rector Magnificus prof. ir. K.C.A.M. Luyben,
voorzitter van het College voor Promoties,
in het openbaar te verdedigen op vrijdag 27 januari 2017 om 10:00 uur
door Remco Hermanus Jozef LOOMAN
Master of Science in Civil Engineering, TU Delft
geboren te Utrecht

Dit proefschrift is goedgekeurd door de

promotor: Prof. dr. ir. A.A.J.F. van den Dobbelsteen

copromotor: Dr. ir. M.J. Tenpierik

Samenstelling promotiecommissie bestaat uit

Rector Magnificus,

Prof. dr. ir. A.A.J.F. van den Dobbelsteen,

Dr. ir. M.J. Tenpierik,

voorzitter

promotor

copromotor

Onafhankelijke leden

Prof. dr. ir. A. van Timmeren,

Prof. P.K. Heiselberg,

Prof. G.P. Keeffe,

Prof. dr. ir. L.S. Schrijver,

Prof. (em.) ir. J.J.M. Cauberg,

Prof. dr. ing. U. Knaack,

Bouwkunde, TU Delft

Aalborg University, Denmark

Queens University, Belfast, UK

Universiteit Antwerpen, België

TU Delft

TU Delft, reservelid

Acknowledgements

It was a long journey with bumps but eventually it resulted in a beautiful destination. Many thanks to everyone that somehow supported me or contributed to this PhD.

Special thanks go out to my promotor Andy van den Dobbelsteen and my co-promotor Martin Tenpierik for their commitment, valuable feedback and patience. I would also like to thank Hans Cauberg for granting me this opportunity as being my initial promotor, and for taking place in my defence committee. I would like to address my gratitude to Professor Arjen van Timmeren, Professor Lara Schrijver, Professor Greg Keeffe and Professor Per Heiselberg for their time, feedback and for taking seat in my defence committee.

Thanks to all architects that I could interest in my research and in particular the ones that reserved some of their precious time for me. Special thanks go out to the architects that provided me with valuable feedback on the tool: Tjerk van de Wetering and Freddie Slot of BYTR, Arjen Spreeuwers from SPR. architectuurstudio, Dennis Hauer and Eirini Sfakiotaki from Urban Climate Architects and Job Schroën from September architectuur.

I would like to thank Sirene Ontwerpers and Véro Crickx in particular for helping me out with the design and layout of this thesis. Véro, you responded to any of my questions in a very quick and satisfying way. I'm happy with the end result.

Thank you to all my (former) colleague's from the section of Climate Design and Sustainability. You maintain a comfortable and friendly environment I can walk into every now and then. A special thank you to Bo Song for helping me out so many times.

Special thanks go out to my shared-office friends of Koornmarkt 48F. Thank you Eric, Esmeralda, Heleen, Marjolein and Michiel for creating the most pleasant working atmosphere I can imagine. An atmosphere in which hard work, professional debates and philosophical chats are complemented with jokes, much needed coffee and the occasional after-work activities. An extra thank you goes out to Eric Burgers for his linguistic support.

I would like to thank my friends and in particular Jeroen & Miriam, Frank & Gosia, Martin & Karin, Jean & Martin and Richard & Marjolein for our social encounters, but above all for your support and occasional listening ears. A special gratitude goes out to Jeroen Coenders for being my paranimf.

A very special gratitude goes out to my business partner, paranimf and friend Marjolein Pijpers van Esch. Thank you for being supportive, motivational and showing me how to finish a PhD. I enjoy our work collaborations and hope we can continue to work together for many years to come.

I would like to thank my family-in-law for providing a homy environment. Thank you for your unconditional support, interest and love.

Now I finally get to thank my dearest Mariëlle for being everything I want and need. You bring balance to everything I do. Thanks for sharing life together.

Contents

1	Introduction	21
1.1	Background	21
1.2	Problem analysis	25
1.3	Research outline	27
1.3.1	Research objectives	27
1.3.2	Research questions and approach	28
1.3.3	Thesis outline	30
1.4	Constraints	31
1.5	Relevance and connection to other research	31
2	Knowledge transfer and transformation in the creative design process	35
2.1	Introduction	35
2.2	How do designers think and work	36
2.2.1	Creativity in design	36
2.2.2	Intuition in design	37
2.2.3	Visualisations in design	38
2.3	How to reach the architect: learning styles	38
2.4	Styles in architectural design	40
2.5	The creative design process	42
2.6	Conclusion	45
7	Contents	

3	Comfort and energy demand of dwellings	47
3.1	Health and comfort in buildings	47
3.1.1	Well-being	48
3.1.2	The thermal indoor environment	49
3.1.3	Indoor air quality	53
3.1.4	Visual comfort	55
3.1.5	The user in control	56
3.2	Energy demand of Dutch dwellings	57
3.2.1	Development of energy demand of Dutch dwellings	57
3.2.2	How to tackle the energy demand	60
3.3	Boundary conditions of the energy concept of design	63
3.3.1	Spatial and functional boundary conditions	63
3.3.2	Comfort-related boundary conditions	65
3.4	Conclusion	67
4	The energy potential of a built environment	71
4.1	Introduction	72
4.2	Climate resources	73
4.2.1	Sun and sky	73
4.2.2	Earth	86
4.2.3	Wind	89
4.2.4	Water	92
4.3	The impact of climate change	96
4.4	Conclusion	98

5	Climate-responsive design	101
5.1	Introduction	101
5.2	Bioclimatic design as the foundation of climate-responsive design	104
5.2.1	Bioclimatic design in theory and practice	104
5.2.2	Other implementations of bioclimatic design	106
5.3	Climate-responsive design	108
5.3.1	The energy balance of a climate-responsive building	109
5.3.2	The building as a responsiveness system	112
5.3.3	Degrees in structural and architectural integration	114
5.3.4	Architectural integration of energy infrastructure	121
5.4	Climate responsive design principles and solutions	123
5.4.1	Climate-responsive design principles	123
5.4.2	Climate-responsive design solutions	127
5.4.3	Climate-responsive building elements	131
5.5	Content requirements for the design support tool	135
6	Climate-responsive building elements toolbox	137
6.1	Introduction	137
6.2	Thermal conservation	139
6.2.1	Adaptable insulation	140
6.2.2	Thermal shutter	142
6.2.3	Translucent insulation	145
6.2.4	Dynamic insulation	147
6.3	Thermal buffering and thermal distribution	149
6.3.1	Thermal mass	150
6.3.2	Thermo-activated building elements	156
6.3.3	Cavity wall heating	158
6.3.4	Ventilated hollow core elements	160

6.4	Passive solar heating	162
6.4.1	Direct solar gain	163
6.4.2	Thermal storage wall	165
6.4.3	Sunspace	168
6.4.4	Roof pond	171
6.5	Earth-coupling	173
6.5.1	Direct contact foundation slab	175
6.5.2	Earth shelter	176
6.5.3	Energy piles	178
6.6	Natural illumination	180
6.6.1	Windows and skylights	182
6.6.2	Light-redirecting window systems	185
6.6.3	Switchable window systems	188
6.6.4	Light shelf	191
6.7	Solar shading	193
6.8	Natural ventilation	197
6.8.1	Solar chimney	198
6.8.2	Wind chimney	202
6.9	Showcase of combined design solutions	204
6.10	Guidelines during the concept development phase	208
6.11	Conclusion	214
7	A framework for a climate-responsive design decision support tool	219
7.1	Requirements	219
7.1.1	Content requirements	220
7.1.2	Functional requirements	220
7.1.3	Form requirements	222

7.2	Concept tool	223
7.2.1	The knowledge base	224
7.2.2	Illustration of custom navigation patterns	235
7.3	Conformation to the requirements	237
7.4	Review by architects	240
7.5	Discussion	243
8	Conclusions and recommendations	247
8.1	Revisiting the research questions	247
8.2	Reflections and recommendations	267
8.3	Outlook	270

Appendices

Appendix A	Description of reference building model used in simulations	275
Appendix B	Curriculum vitae	279
Appendix C	List of related publications	280

Summary

In climate-responsive design the building becomes an intermediary in its own energy housekeeping, forming a link between the harvest of climate resources and low-energy provision of comfort. Essential here is the employment of climate-responsive building elements, defined as structural and architectural elements in which the energy infrastructure is far-reaching integrated. This thesis presents the results of research conducted on what knowledge is needed in the early stages of the design process and how to transfer and transform that knowledge to the field of the architect in order for them to successfully implement the principles of climate-responsive design. The derived content, form and functional requirements provide the framework for a design-decision support tool. These requirements were incorporated into a concept tool that has been presented to architects in the field, in order to gain their feedback.

Climate-responsive design makes the complex task of designing even more complex. Architects are helped when sufficient information on the basics of climate-responsive design and its implications are provided as informative support during decision making in the early design stages of analysis and energy concept development. This informative support on climate-responsive design should address to different design styles in order to be useful to any type of architects.

What is defined as comfortable has far-reaching implications for the way buildings are designed and how they operate. This in turn gives an indication of the energy used for maintaining a comfortable indoor environment. Comfort is not a strict situation, but subjective. Diversity is appreciated and comfort is improved when users have the ability to exert influence on their environment. Historically, the provision of comfort has led to the adoption of mechanical climate control systems that operate in many cases indifferent from the building space and mass and its environment. Climate-responsive design restores the context of local climate and environment as a design parameter. Many spatial, functional and comfort-related boundary conditions that have an effect on the energy design concept have been distinguished.

There are many low-graded energy sources that can be put to use in the built environment, with local climate as the primary component. When exploring the potential of local climate, urban context needs to be taken into account since it heavily affects the actual potential. Since buildings are typically build to last for decades, consideration of changing climate and its expected effect on the energy potential is an important factor in the strategy to follow. The study of the energy potential of local climate resulted in a set of climate-related and context-related boundary conditions.

The principles of climate-responsive design - the conceptual relations between energy source, energy treatment and comfort demand - can be translated into various design solutions, the contextual, architectural and technical implementation of these principles into an actual design. The design solutions can be divided into six categories - site planning, building form and layout, skin, structure, finish and (integrated) building service - that cover various dimensions in planning and construction. In this thesis a non-exhaustive list of design principles and solutions is presented using different matrices.

In order to design using climate-responsive design principles the architect should be given an overview of the comfort contribution and energy performance of design solutions. Furthermore, the identification of collaborations and conflicts when using multiple design principles together is essential. The generation of a satisfying design is more than just stacking solutions upon each other. It should also be made clear what a possible energy function of a building element is besides its primary function. This is where comfort and energy related design objectives of climate-responsive design meet other objectives (i.e. spatial, functional and structural). Finally, the impact of climate-responsive building elements on the appearance of design is relevant to concept orientated architects. Together this can be considered as the content requirements of the design-decision support tool.

In the early stages of the design process climate-responsive design is about the generation of energy concepts. In this phase accessible guidelines and the option to compare alternatives is more important than to assess absolute performance. The conceptual design phase is dynamic and has many iterations. Informative, context-specific knowledge reduces the number of iterations before the architect has generated a satisfying number of design options from which it can continue to the next design phase of assessment. Functional requirements for the framework of the design-decision support tool are the inclusion of a knowledge base with expert knowledge and best practice examples, the provision of informative, context-specific knowledge, the provision of accessible guidelines, the provision of an option to compare alternatives, the inclusion of the ability to inform during and assist in decision-making (i.e. intelligence) and the limitation of complexity and the generation of easy to interpret output.

The tool is primarily developed for the architect so it needs to blend in the architect's workflow enabling the architect's creativity and guiding his intuition. Other form requirements of the design-decision support tool are the presence of customisation options and custom navigation patterns, all presented in a visual style.

A concept of the web-based tool has been developed in order to illustrate what a climate-responsive design-decision support tool could look like. The heart of the tool is formed by the knowledge base, constructed from items grouped into one of four

categories: principles, solutions, projects and guidelines. Relationships between items are incorporated within the knowledge base as hyperlinks, which makes it easy to navigate from one item to another. The stored information is presented in numerous ways. Info sheets provide the most detailed presentation style containing all available information for an item, while catalogues, matrices and a gallery provide quick overviews and reveal direct relationships with other items.

In order to become a true design-decision support tool, the presented tool needs to be further developed. This includes the use of a more context-specific presentation style and the inclusion of more context-specific knowledge, the addition of layers in which the knowledge is presented varying from more general to practical, the development and implementation of performance indicators and a more direct and visual approach to pinpoint synergetic and conflicting effects.

By using the tool, architects can access relevant knowledge in different ways that suit their method of working. It enables the presentation of complex relationships in a clear way and by doing so unlocking a much broader part of the content to them. That will help speeding up the proces of design iteration before the energy concept can be assessed in the successive phase of the design process.

Samenvatting

Met klimaat-responsief bouwen wordt het gebouw een intermediair van zijn eigen energiehuishouding. Het vormt de schakel tussen het oogsten van energie uit de directe omgeving en de duurzame realisatie van comfort. Essentieel is hier de inzet van klimaat-responsieve bouwelementen, gedefinieerd als de bouwkundige en constructieve bouwelementen waarin de energie-infrastructuur vergaand is geïntegreerd. In dit proefschrift worden de resultaten gepresenteerd van een onderzoek naar welke kennis omtrent klimaat-responsief bouwen nodig is in de eerste fasen van het ontwerpproces en hoe deze kennis vertaald en omgevormd dient te worden naar het vakgebied van de architect opdat de principes van klimaat-responsief bouwen succesvol geïmplementeerd kunnen worden. Er zijn eisen opgesteld ten behoeve van inhoud, form en functie welke de basis vormen voor een raamwerk van een hulpmiddel voor de ondersteuning bij het nemen van ontwerpbeslissingen. Een proefmodel van het hulpmiddel is voorgelegd aan praktiserende architecten met als doel het vergaren van feedback ter verbetering van het proefmodel.

Klimaat-responsief bouwen maakt de toch al complexe taak van ontwerpen nog complexer. Architecten zijn gebaat bij beschikbaarheid van kennis van de uitgangspunten van klimaat-responsief bouwen en de implicaties ervan tijdens het nemen van beslissingen in de vroegste fase van het ontwerpproces; de analyse en de ontwikkeling van het energieconcept. Deze gepresenteerde kennis moet aansluiten bij verschillende ontwerpstijlen om bruikbaar te zijn voor elke individu.

De definitie van comfort is van grote invloed op hoe gebouwen worden ontworpen en hoe zij worden gebruikt. En dat is weer voor een groot deel bepalend voor het energiegebruik ten behoeve van de realisatie van een comfortabel binnenklimaat. De beleving van comfort is subjectief. Diversiteit wordt gewaardeerd en het comfort is beter als gebruiker de mogelijkheid heeft om invloed uit te oefenen op zijn of haar omgeving. Historisch gezien heeft de realisatie van comfort geleid tot de afhankelijkheid van installaties die vaak onafhankelijk werken van het gebouw en de omgeving waarin het staat. Met klimaat-responsief bouwen wordt lokaal klimaat en omgeving weer als ontwerpparameter beschouwd. Verschillende ruimtelijke, functionele, comfort-gerelateerde randvoorwaarden die van invloed zijn op het energieconcept zijn opgesteld.

Er zijn verschillende bruikbare energiebronnen beschikbaar in een bebouwde omgeving, als direct resultaat van het lokale klimaat. Bij de verkenning van het energiepotentieel van het lokale klimaat dient de stedelijke context in beschouwing genomen te worden omdat deze van grote invloed is op het werkelijk potentieel. Omdat gebouwen over het algemeen meerdere decennia meegaan is de beschouwing van

klimaatverandering en de impact ervan op het energiepotentieel van het lokale klimaat een belangrijk aspect in de te volgen strategie. De studie naar het energiepotentieel van het lokale klimaat heeft geleid tot een verzameling klimaat- en context gerelateerd randvoorwaarden.

De principes van klimaat-responsief bouwen - de conceptuele relaties tussen energiebron, energiebehandeling en comfortvraag - kunnen concreet gemaakt worden in verschillende contextuele, bouwkundige en technische ontwerp oplossingen. Deze oplossingen kunnen verder onderverdeeld worden in zes categorieën (bouwplaats, vorm en indeling, schil, constructie, afwerking en (geïntegreerde) installaties) en raken daarmee aan verschillende stappen gedurende ontwerp, planning en realisatie van een gebouw. Een niet uitputtende lijst met principes en oplossingen van klimaat-responsief bouwen is gepresenteerd in verschillende matrices.

Om te kunnen ontwerpen volgens de principes van klimaat-responsief bouwen heeft de architect inzicht nodig in de bijdrage aan het geboden comfort en de energieprestatie van de verschillende ontwerp oplossingen. Verder is het belangrijk dat inzicht verkregen wordt in de potentiële meerwaarde van het combineren van verschillende oplossingen, of wanneer het combineren van oplossingen juist leidt tot mogelijke conflicten. De realisatie van een goed ontwerp is meer dan alleen het stapelen van oplossingen. Het moet ook duidelijk zijn welke mogelijke bijdrage een element kan hebben in de energiehuishouding, naast zijn primaire functie. Hier komen de comfort- en energie-gerelateerde doelstellingen van klimaat-responsief bouwen in aanraking met onder andere ruimtelijke, functionele en constructieve doelstellingen. Tenslotte moet de visuele impact die klimaat-responsieve bouwelementen hebben op het ontwerp zichtbaar gemaakt worden. Tezamen vormen dit de inhoudelijke eisen van het hulpmiddel.

In de eerste fasen van het ontwerpproces gaat het bij klimaat-responsief ontwerpen om de ontwikkeling van energieconcepten. In deze fase zijn hanteerbare richtlijnen en de mogelijkheid om verschillende oplossingen met elkaar te vergelijken belangrijker dan een absoluut gekwantificeerde prestatie. De conceptuele ontwerp fase is dynamisch en kent meerdere iteraties. Informatieve, context-specifieke kennis vermindert het benodigd aantal iteraties om tot een bevredigend ontwerp te geraken. Functionele eisen aan het raamwerk van het hulpmiddel zijn het opnemen van een kennisbank met gespecialiseerde kennis en project voorbeelden, het bieden van informatieve, context-specifieke kennis, het presenteren van hanteerbare richtlijnen, de mogelijkheid bieden om oplossingen met elkaar te vergelijken, de mogelijkheid bieden om met een zekere intelligentie te informeren bij het nemen van ontwerpbeslissingen, en het verzorgen van eenduidig te interpreteren output.

Het hulpmiddel is in principe ontworpen voor de architect en dient zodoende geïntegreerd kunnen worden in zijn of haar manier van werken, waarbij het ruimte laat

voor creativiteit en richting geeft aan de intuïtie. Overige eisen aan de vorm van het hulpmiddel zijn de mogelijkheid bieden om het hulpmiddel aan te passen aan de eigen voorkeuren en de mogelijkheid bieden om vrij te kunnen navigeren door de inhoud. Dit alles zo veel mogelijk visueel gepresenteerd.

Een web-based proefmodel van het hulpmiddel is uitgewerkt om te kunnen illustreren hoe zo'n hulpmiddel eruit zou kunnen zien. Het hart van het hulpmiddel wordt gevormd door de kennisbank, samengesteld uit items gegroepeerd binnen vier categorieën: principes, oplossingen, (voorbeeld)projecten en richtlijnen. De relaties tussen de verschillende items zijn als kruisverwijzingen opgenomen waardoor eenvoudig van het ene item naar het andere item genavigeerd kan worden. De opgeslagen informatie wordt op verschillende manieren gepresenteerd. Informatiebladen presenteren de meest gedetailleerde weergave van de beschikbare informatie per item, terwijl catalogi, matrices en een fotogalerij een snel overzicht geven van de verschillende relaties.

Het hulpmiddel moet verder ontwikkeld worden om de waarde ervan bij het nemen van ontwerpbeslissingen te vergroten. Deze ontwikkeling is gericht op het verzamelen van meer context-specifieke kennis en het context-specifiek presenteren van de kennis, de implementatie van lagen waardoor de geboden kennis gepresenteerd kan worden van generiek tot praktisch, de ontwikkeling en implementatie van prestatie-indicatoren en meer directe en visuele presentatie van synergetische en conflicterende effecten.

Door het gebruik van het hulpmiddel hebben architecten toegang tot relevante kennis dat aansluit bij hun manier van ontwerpen. Het toont complexe relaties in een heldere weergave en ontsluit zo een groter deel van de informatie. Dit helpt de architect door het versneld kunnen ontwikkelen van verschillende energieconcepten alvorens deze te toetsen in een volgende fase van het ontwerpproces.

1 Introduction

§ 1.1 Background

The human impact

Human activities around the world leave an incredible mark on the earth, its resources and its inhabitants. Today we consume valuable resources of the earth at breakneck speed from the short-sighted point of view of the here and now. The results are resource depletion, scenery damage, waste production and pollution.

The human impact is perhaps most notable in terms of climate change, for which the emission of greenhouse gases is identified as the primary cause. The emission of carbon dioxide from the burning of fossil fuels is the most significant contributor (Intergovernmental Panel on Climate Change, 2014). Climate change is already a serious direct threat to human life and well-being and will most likely emerge in the upcoming decades (Intergovernmental Panel on Climate Change, 2014; World Health Organization, 2016).

The recurring human impact is also noticeable in long term economical and socio-political perspectives. Take for example our enormous dependence on fossil fuels. It has already led to uncertainties in availability and pricing and it may be obvious that the rapid development of upcoming industries could stress the worldwide energy supply even more. As a result international relationships between suppliers and consumers of these primary energy sources are intensifying.

As for today 81% of the world's energy needs is met by fossil energy sources (coal, oil and natural gas) (International Energy Agency, 2016). With current policies the worldwide energy consumption is expected to increase with 48% from 2012 to 2040 (Energy Information Administration, 2016). Despite renewable energy being the world's fastest-growing source of energy, fossil fuels are expected to meet 78% of total energy demand by 2040 (Energy Information Administration, 2016). This is without a doubt a serious threat to our common future. The rising need for raw materials and fresh water could unleash similar disastrous scenarios as well.

The impact of the built environment

For centuries now humans have been constructing a built environment, a vast network of cities and supporting infrastructure, in which they can deploy their activities. The first man-made structures provided basic needs as shelter or protection and were made from the available materials nearby the site. In time humanity advanced and so did its structures; emerging into a craft where aesthetics and impression gained importance. New activities called for new types of buildings (e.g. temples, workshops and marketplaces). Non-domestic construction materials were introduced by retrieving them from sites further away and structures became bigger to impress people even more. Due to its increasing complexity, the creation of the built environment became an expertise, managed by an architect. And architecture evolved from vernacular to monumental.

The impact of the built environment on the natural environment boosted after the industrial revolution. Increasing wealth and the development of new technology catapulted the dimension and proportion of the built environment, demanding more and more of our resources. The provision of shelter transformed into the urge to control the indoor environment to meet occupants' best wishes. This resulted into the implementation of mechanical climate control systems which provide heating, cooling and ventilation while operating almost completely stand-alone from the building structure and its environment. Building systems were designed from the single objective of controlling indoor conditions, passing over many comfort and energy aspects.

Things first changed after the 'oil crisis' of 1973, an artificial crisis created by a political conflict. From this moment on energy saving became of progressive concern leading to significant reduction in energy consumption of buildings achieved through increased insulation, enhanced air tightness and by improved efficiency of building systems for climate control.

But despite increased concern, on-going research and practical efforts made so far, the building sector still demands a lot of our resources and generates great amounts of waste and pollution. With prospects of population growth, upcoming expansion of new economies, accompanying creation of new wealth and more stringent requirements on health and comfort, resource consumption by the built environment is expected to increase if there is no change in current practice and policy (Energy Information Administration, 2016).

All these prospects force us to think differently about our resource consumption and opt for a transition towards a sustainable state where we minimize the need for raw materials and maximize their re-use, conserve fresh water supplies and become independent of non-renewable energy sources.

The evolution of climate control in buildings

The desire to control the indoor environment to the occupant's best wishes resulted in the implementation of mechanical climate control systems that operate completely separate from the rest of the building. And buildings themselves became completely separated from the (outdoor) environment they were placed in.¹ Or as Maver (1971) puts it: "One of the most marked trends in architecture over the centuries has been that of replacing the functions of the building structure by engineering service systems".

One aim of building design is to create a satisfying and healthy atmosphere in which we can deploy our activities, whether these activities are residential, recreational, educational, or work related. The design of a comfortable indoor climate is of great influence on occupant's health. There is a strong relation between improved indoor climate and increased performance of employees or students and decreased absenteeism (Fisk & Rosenfeld, 1997; Preller et al., 1990; Wargocki et al., 2005). Think of the more severe consequences discomfort could have on vulnerable people such as the elderly or hospital patients. While humans in the industrialised countries spend on average 85% of their time indoors, the creation of comfortable and healthy buildings is an absolute necessity.

The need to control the indoor climate resulted in the implementation of building systems specifically designed to fulfil this purpose. But these systems do not always establish improved comfort and health benefits. For example, complaints from occupants of the residential development Vathorst in Amersfoort, the Netherlands, got a lot of media attention and resulted in a study into the relation between occupant complaints and mechanical ventilation systems (Leidemeijer et al., 2009). It was concluded that poor installation and noise production were to be blamed for most of the complaints. Furthermore, the presence of mechanical ventilation systems was identified as the cause for worsened indoor air quality which could lead to health complaints, especially with balanced ventilation systems.

There is more evidence that the use of building systems increases the number of complaints about the indoor climate. Some studies made clear that the mechanically controlled indoor environments that function completely separated from the outdoor environment can even be far from comfortable and healthy (Mahdavi & Kumar, 1996).

1 Typical newly-built dwellings in industrialised countries operate on climate control systems that rely heavily on auxiliary (fossil) energy and operate rather indifferent to dynamic climatic conditions. For example in the Netherlands, primary comfort systems include balanced ventilation systems and gas-fired boilers for space heating and domestic hot water production.

Different from what might be expected is that in many cases building services are operating as was asked for in the design specifications. So they were installed properly and work as intended to. Wrong formulation of specifications can be explained from a lack of information on occupancy, performance of design or the implementation within the design process (Den Hartog, 2003).

All this clearly shows that building systems were designed from the single objective of apparent comfort provision while energy-efficiency was not considered at all. It seems that at a time when consuming energy did not ring a bell on resource depletion and environmental damage, comfort provision became synonym for high energy consumption. This is by no means necessary (Roulet, 2006). Moreover, the implementation of mechanical building systems did not result in improved comfort at all.²

Towards a more sustainable energy housekeeping

The path to sustainable energy housekeeping for buildings is transitional and embraces improving existing techniques, presenting new innovative solutions and thinking in whole new concepts. A three-step approach commonly known as the Trias Energetica³ has been all the rage in tackling the energy problem since the late 1980s (Duijvestein, 1989; Lysen, 1996). The Trias Energetica embraces the following three steps:

- 1 Energy demand reduction
- 2 Renewable energy employment
- 3 Clean and efficient use of fossil fuels

In order to tackle the energy problems different approaches can be thought of based on the steps of the Trias Energetica. These approaches can start from different scale levels or from different design concepts or used technologies. For instance, energy problems may be dealt with on the scale of a single building that becomes self-sufficient or on a wider scale ranging from neighbourhoods to cities that can benefit from community services.

2 On the other hand it is good to realise that low-energy design of buildings, where no attention is paid to comfort and health, can as well become non-sustainable due to higher energy use by occupants to compensate for any discomfort (Nicol & Humphreys, 2002).

3 The basics of the three step approach were first mentioned by Duijvestein (1989) and are applicable to a more general strategy of tackling environmental problems. A three step approach with a specific focus on energy was later named Trias Energetica by Lysen (1996) which has since become a synonym for the three step approach to tackle energy problems. However, Lysen mentioned the increase in energy efficiency as the first step, rather than prevention. Nowadays energy demand reduction is generally considered as the initial step and energy efficiency is merely associated to the use of fossil fuels in the third step (more info in chapter 2).

Other approaches may focus on a certain design philosophy that embraces one or more specific design features and is transformed into a design concept (e.g. Passive House⁴, ZED⁵) or on technology where new or more energy-efficient building systems are seen as the way forward.

Any advanced strategy should head towards banning the use of non-renewable energy sources entirely for all the obvious reasons; ruling out the third step of the Trias Energetica. Alternatively, one could benefit from the ubiquitous renewable energy resources in the immediate environment such as direct solar radiation, daylight, natural air flows and the earth's high thermal storage capacity. By using the energy potential of the immediate environment, a comfortable and healthy environment can be created that contributes to the reduction of energy consumption and, by banning out fossil fuels, eliminates undesired side-effects of pollution and waste generation.

The initial step of demand reduction stays valid both in times of scarcity and abundance of energy sources. On the building scale the limits of demand reduction can probably be found at the junction of making the most out of the potential of local energy offer and fitting it closely to user needs, complemented with strategies such as conservation, recovery and storage. A hereby connecting factor is the concept of responsive buildings; buildings that can respond to changing circumstances in both the supply and demand of energy.

§ 1.2 Problem analysis

The key in successfully applying the energy potential within the built environment for the creation of comfortable buildings is to bridge the discrepancy between patterns in space and time of the natural energy supply and building energy demand. The responsive ability of a building can form that link between the lack of natural energy sources due to the dynamics of local climatic conditions and low-energy provision

4 The concept of the Passive House is based on high thermal insulation and enhanced air tightness complemented by active systems for ventilation. It is a well-developed concept with many built examples, mainly located in Germany, Austria and Scandinavia. The definition of a residential Passive House poses a maximum level for annual energy use for space heating of 15 kWh/m² and a total annual primary energy consumption of 120 kWh/m² (Passive House Institute, 2015).

5 ZED stands for zero (fossil) energy development and branded after the realisation of the mixed use development Beddington ZED (or BedZED) in 2002 in Sutton near London. The philosophy behind ZED is that the design, construction and refurbishment of developments should only use renewable energy sources with no direct carbon emissions (Dunster et al., 2008).

of comfort. Buildings with responsive abilities - or climate-responsive buildings - become an intermediary in their own energy housekeeping. Essential here is the implementation of climate-responsive building elements, structural or architectural elements in which energy harvest and complementing energy strategies such as distribution are far-reaching integrated. Climate-responsive building elements form the main topic within this research. While the concept of employing the energy potential of the built environment is not entirely new, a widespread implementation of climate-responsive building concepts is not yet seen.

Climate design and the role of the architect

In general, a design process is a highly complex practice in which the architect plays an important role. Architectural design has to meet a variety of design objectives that heavily interrelate with each other and in many cases are in conflict. The challenge to create comfortable and healthy indoor environments and to reduce energy demand of buildings calls for creative solutions that elaborate on existing knowledge and good practice.

In many projects the architect is the project manager and therefore the architect is responsible for the integration of all different objectives into a single building design. The architect is in many cases also the one person that sets course to a final building concept. The architect's creative behaviour induces new and original ideas which are needed to advance and cope with existing and new problems (Sternberg, 2005).

Climate design is the part of design that is concerned with the creation of healthy and comfortable indoor environments. Climate design starts with the right design requirements set by the principal. But they often fail to state clear and verifiable demands for the indoor climate to be achieved in the design. Many elementary design decisions made by the architect determine the initial quality of the indoor climate; although often not recognised by the architects themselves. Decisions on building form, material use and natural illumination may be made to suit another aspect of design, but have at the same time consequences for the indoor climate. And at the very same time they also address energy related aspects of building design. They determine if and what additional building systems for heating, cooling, artificial lighting or ventilation are needed.

Climatic design, or designing comfortable and healthy environments, is often neglected as a (co)responsibility of the architect. There is little coordination between knowledge on performance of design and its implementation in the design process. Architects often do not know how to translate available knowledge on performance of design into their design concepts. In many cases this knowledge is not quickly or easily accessible; most building simulation tools produce detailed output that takes time, effort and skill to be interpreted. As a consequence wrong design rules are used which result in the implementation of non optimal design solutions.

§ 1.3 Research outline

§ 1.3.1 Research objectives

The objective of this research is to develop guidelines and a method of obtaining knowledge for climate-responsive design and introduce them to the design process in such a way that it assists architects in their design practice. Next to making the architect aware of the energy and comfort impact of their (climate-responsive) design decisions, an important aspect is the identification of the structural and architectural impact of the implementation of climate-responsive building elements.

Knowledge on climate design can be introduced to the design process by the employment of climate consultants. However, their specific knowledge and skills are usually involved in the later phases of the design process. At those stages weaknesses of the proposed building design exposed by climate design analysis can often only be undone by means of considerable design changes that are in conflict with design decisions that were made earlier in the process. This is the case in particular for climate-responsive design due to the far-reaching integration. So, it will be helpful to both the architect and the climate engineer when the engineer's knowledge on climate-responsive design and climate-responsive building elements in particular is translated into the language of the architect and transformed into a form that fits to the conceptual character of the early design stages.⁶

Expected outcomes of this research include a framework for a design support tool in which knowledge on climate-responsive design is collected and presented in such a way that it assists the architect in making well-founded decisions on the application of climate-responsive design.

6

It would of course also be helpful when the climate engineer 'understands' how the architect thinks and works. However, this is outside the scope of this research.

§ 1.3.2 Research questions and approach

Derived from the problem analysis and the before mentioned research objectives the following main research question is formulated:

How can architects fully exploit the potential of natural energy sources within the built environment in their process of designing comfortable low-energy dwellings using climate-responsive building elements?

In order to answer the main question, the following sub questions are researched consecutively:

1 *How can knowledge on climate-responsive design best be made available to the architect?*

To build a body of knowledge on climate-responsive design by itself does not guarantee proper implementation in final design. In fact, the opposite may be true when the knowledge is not available in the language of the one that has to work with that information.

From a literature review on the topics of 1) how designers think and work, 2) how designers learn, 3) architectural design styles, and 4) the creative design process, the preferred language of the knowledge is researched. The results are presented in chapter 2.

2 *What are the comfort and energy demands in relation to climate-responsive design?*

A primary objective of building design is to provide healthy and comfortable indoor environments, in which humans can work, dwell or perform any other activity that contributes to their well-being. What is defined as comfortable has far-reaching implications for the way buildings are designed and how they are operated, which in its turn gives an indication of the energy used for maintaining a comfortable indoor environment.

In chapter 3 general knowledge and state-of-the-art insight in the design of comfortable buildings is derived from a literature review. It is explained how we meet comfort related energy demands in buildings today and suggests a way towards a sustainable energy strategy. The chapter concludes with an elaboration on the relevant boundary conditions (spatial, functional and comfort-related) and their impact on the energy concept of a design.

3 *What is the potential of natural energy sources within the built environment?*

There are many low graded energy sources within a built environment that can be put to use, driven by local climate. In order to exploit the potential of local climate one needs to understand its dynamics. However, within urban areas the local climate can be significantly distorted by urban tissue and layout, and thus generates a different energy potential.

In chapter 4 the energy potential of a built environment is presented, down to the level of local climate and influences of an urban setting. The results are based on a literature review, partially complemented with newly conducted research in the form of simulations. The chapter concludes with a discussion of the effects of the climate-related boundary conditions on the energy concept design of buildings.

4 ***What are the underlying principles of climate-responsive design and how can they be transformed into actual design solutions?***

In chapter 5 the definition of climate-responsive design is further established by positioning the concept in relation to common terms used in the field of passive and low-energy design, and discussing relevant aspects such as responsiveness and spatial and structural design. By explaining the underlying principles of climate-responsive design, a list of climate-responsive design solutions - as the actual integration of these principles in design - is logically deduced.

The chapter concludes with the content requirements for the design decision support tool, logically deduced from the theoretical framework deduced under sub question 1 and the gathered and generated knowledge following sub questions 2 and 3.

5 ***What specific knowledge on climate-responsive design solutions is needed to fill the design support tool?***

In chapter 6 the content requirements for many climate-responsive design solutions are filled in with aid of an extensive literature review. Many design principles and solutions lend themselves for improved overall performance through collaboration. The chapter concludes with a section that briefly presents some of these combined solutions and with some guidelines how to identify potential collaborations and possible conflicts.

6 ***What is the best form for a design-decision support tool to transfer knowledge on climate-responsive design to the architect?***

In chapter 7 the design support tool will be given form. The outcomes of the conducted research in order to answer the preceding sub questions are complemented with a literature analysis of (architectural) design decisions support tools in order to determine the essentials to tackle with the climate-responsive design design-decision support tool. The resulting requirements for content, function and form become the foundation for the framework for the support tool. A concept for the tool is presented and discussed. With aid of feedback collected from architects using the tool, recommendations are stated for the future development of the tool.

§ 1.3.3 Thesis outline

In resumé, the main research question is answered by consecutively answering the six sub questions that are dealt with in six consecutively chapters, namely chapters 2 to 7. The thesis outline is shown in [Figure 1.1](#).

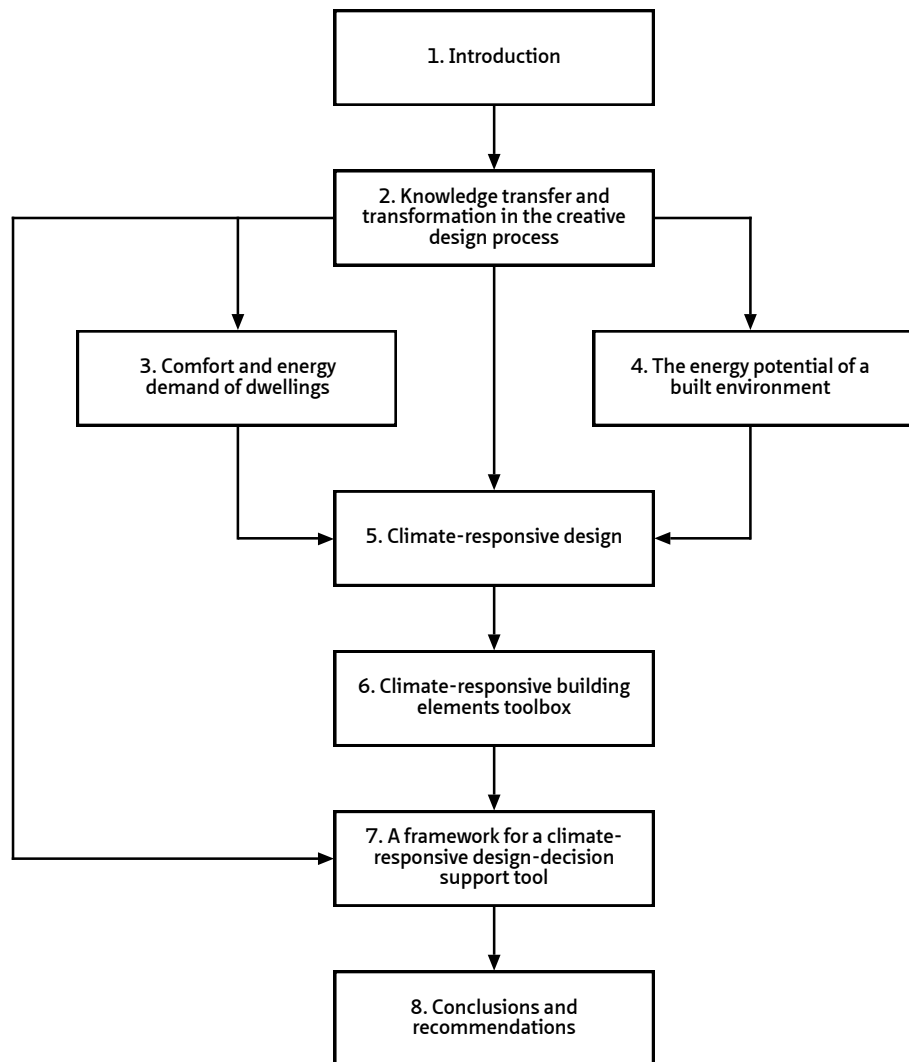

FIGURE 1.1 Thesis outline

§ 1.4 Constraints

Climate-responsive design has potential in all building types and in all climates. Therefore it will be considered in a context as general as possible, but with a slight focus on the design of newly-built dwellings in a Dutch context for reasons described below.

Some major advances in energy-efficiency of the built environment can be expected in the field of housing. Firstly, energy conservation in common building design practice still has a large focus on technical improvement at component level. In a typical newly-built dwelling in the Netherlands, installations such as mechanical ventilation and gas-fired boilers - and more recently electrical heat pumps - for both space heating and the provision of domestic hot water have become the standard set of equipment for providing comfort. Secondly, despite a significant drop in volume since the global financial crisis of 2007-2009 - the Dutch Government steered towards an average of 80.000 new dwellings per year before the crisis (TNO, 2008) - housing production values are relatively high, averaging just under 48.000 a year (2012-2015; <http://statline.cbs.nl>). Such numbers make dwellings in the Netherlands very well suitable for the implementation, application and evaluation of climate-responsive design principles.

Climate-responsive design has less constraints and therefore greater opportunities in newly designed buildings. But implementation of climate-responsive design in transformation and renovation projects is very well possible. Moreover, it is very vital since the existing building stock with over 7 million dwellings contributes to a large extent to overall residential energy consumption and related CO₂ emissions. Moreover, in the near future the creation of new housing will likely be dominated by renovation and transformation projects.

§ 1.5 Relevance and connection to other research

Societal relevance

The building industry heavily depends on energy produced from fossil minerals. Therefore it has become a significant contributor to overall energy consumption and CO₂ emissions. The EU and its member states acknowledge that action needs to be taken and address this in their policy on climate change. At EU-level the 2020 target - in the form of binding legislation - is set to a 20% reduction in greenhouse gas emissions (with respect to 1990 levels), an increase of the share of renewable

resources to 20%, and 20% improvement in energy efficiency (European Commission, 2016a). From this EU goal, the Netherlands is bound to a 16% CO₂ emission reduction⁷ and a 14% renewable energy share (Government of the Netherlands, 2016). Late 2014 members of the EU reached an agreement on new targets for 2030, which are a greenhouse gas reduction of at least 40%, an increase in the share of renewable energy with at least 27%, and a reduction of total energy use with at least 27% (European Commission, 2016b).

The necessity of an energy transition is also vital in an economical and socio-political perspective. The dependence of industrialised countries on fossil fuels has led to uncertainties in availability and pricing which resulted in an intensification of international relationships between suppliers and consumers of primary energy resources.

Scientific relevance

Although many advances have been made already, current design practice falls behind technical developments and innovation in the field of sustainable building. There are a lot of good examples of sustainable building design but this has not led to a general shift in practice. An integrated use of climate-responsive design principles can lead to a combined improvement on both comfort and energy issues.

This research aims at a synthesis between architectural and climatic issues in building design and its process. The starting point is the creation of comfortable and healthy dwellings which upon realisation also aim at the exclusion of non-renewable energy sources. Original elements of this research are the method of approach where climate-responsive design forms the basis for low-energy building design and the dedication of knowledge to general architectural practice. The gathered knowledge is translated for practical use and connects to the architectural design process.

Connection to other research

In a strategic vision of the project group Duurzame Energie Projectontwikkeling Woningbouw (DEPW, 2005) it is acknowledged that there is a need for a transition to high performance new building concepts and new views on construction, renovation and urbanism in order to satisfy on the one hand the increasing demands concerning comfort and on the other hand reducing energy consumption and environmental impact.

7

This 16% reduction is to be realised without the use of the EU emissions trading system (ETS), in which countries can trade CO₂ emission rights.

The project group DEPW connects to the international research collaboration of the Annex 44 which is formed by about 25 research institutes, universities and private companies from 13 countries (International Energy Agency, 2006). The Annex 44 is initiated by the International Energy Agency (IEA) within the Implementing Agreement entitled Energy Conservation in Buildings and Community Systems (ECBCS). The Annex 44's main objectives are:

- State-of-the-art review of climate-responsive building elements, integrated building concepts and environmental performance assessment methods.
- Improvement and optimisation of climate-responsive building elements.
- Development and optimisation of new building concepts with integration of climate-responsive building elements and renewable energy systems.
- Development of guidelines and procedures for estimation of environmental performance of climate-responsive building elements and integrated building concepts.

One of the main features of climate-responsive design is the application of climate-responsive building elements. Within the Annex 44, and throughout this research, such elements are described as:

Building construction elements actively used for transfer and storage of heat, light, water and air. This means that construction elements, like floors, walls, roofs, foundation etc., are logically and rationally combined and integrated with building services systems such as heating, cooling, ventilation and lighting.

According to the Annex 44 statement, the development, application and implementation of climate-responsive building elements are considered to be a necessary step towards further energy efficiency improvements in the built environment.

The focus of this thesis is on the application of climate-responsive design of dwellings; with climate-responsive building elements in particular, and how architects become able to apply them in their design. Key aspect is the gathering of knowledge on structural and architectural impact of design solutions and their contribution to comfort and energy performance.

References

- Den Hartog, J.P. (2003) *Designing Indoor Climate - a thesis on the integration of indoor climate analysis in architectural design*. Delft, The Netherlands: DUP Science.
- DEPW (2005) *Duurzame Projectontwikkeling gebaseerd op duurzaam bouwen, renoveren en wonen na 2015*. Den Haag, The Netherlands: Author.
- Duijvestein, K. (1989) *An Ecological Approach to Building in Riedijk, W., Boes, J. and Ravesteijn, W. [eds.] (1989) Appropriate Technology in Industrialized Countries*, pp. 235-267. Delft, The Netherlands: Delft University Press.
- Dunster, B., Simmons, C., and Gilbert, B. (2008) *The ZEDbook: Solutions for a shrinking world*. Abingdon, England: Taylor & Francis.
- Energy Information Administration (2016) *International Energy Outlook 2016*. Washington: Author.
- European Commission (2016a) 2020 climate & energy package. Retrieved from <http://ec.europa.eu/clima/policies/strategies/2020/>
- European Commission (2016b) 2030 climate & energy framework. Retrieved from <http://ec.europa.eu/clima/policies/strategies/2030/>
- Fisk, B. and Rosenfeld, F. (1997) Estimates of improved productivity and health from better indoor environments in *Indoor Air 1997*, vol. 7, pp. 158-172.
- Government of the Netherlands (2016) Dutch goals within the EU. Retrieved from <https://www.government.nl/topics/climate-change/contents/eu-policy>
- Intergovernmental Panel on Climate Change (2014) *Climate Change 2014: Synthesis Report. Contribution of Working Groups I, II and III to the Fifth Assessment Report of the Intergovernmental Panel on Climate Change* [Core Writing Team, R.K. Pachauri and L.A. Meyer (eds.)]. Geneva, Switzerland: Author.
- International Energy Agency (2016) *World Energy Balances 2016 edition*. Paris, France: Author.
- International Energy Agency (2006) *IEA ECBCS Annex 44 research programme*. Retrieved from <http://www.civil.aau.dk/Annex44/>
- Leidemeijer, K., Menkveld, M., Cozijnsen, E. and Heemskerck, H. (2009) *Mechanische ventilatie in nieuwbouwwoningen - Ervaringen en oordelen van bewoners over de kwaliteit van ventilatie en de eigen gezondheid*. Amsterdam, The Netherlands: RIGO.
- Lysen, E.H. (1996) *The Trias Energica: Solar Energy Strategies for Developing Countries in proceedings of Eurosun Conference 1996*, Freiburg, Germany.
- Mahdavi, A. and Kumar, S. (1996) Implications of indoor climate control for comfort, energy and environment in *Energy and Buildings*, vol. 24, issue 3, pp. 167-177.
- Maver, T. (1971) *Building Services Design: A Systematic Approach*. London, England: RIBA.
- Nicol, J.F. and Humphreys, M.A. (2002) Adaptive thermal comfort and sustainable thermal standards for buildings in *Energy and Buildings*, vol. 34, issue 6, pp. 563-572.
- Passive House Institute (2015) *Passive House Requirements*. Retrieved from http://www.passiv.de/en/02_informations/02_passive-house-requirements/02_passive-house-requirements.htm
- Preller, L., Zweers, T., Brunekreef, B. and Boleij, J. S. M. (1990) Sick leave due to work-related health complaints among office workers in the Netherlands in *Proceedings of Indoor Air 1990*, vol. 1, pp. 227-290.
- Roulet, C.-A. (2006) Indoor air quality and energy performance of buildings in *Proceedings of Healthy Buildings 2006*, vol. 1, pp. 37-47.
- Sternberg, R.J. (2005) Creativity or creativities? in *International Journal of Human-Computer Sciences*, vol. 63, pp. 370-382.
- TNO (2008) *Bouwprognoses 2008-2013, TNO Bouw en Ondergrond*. Delft, The Netherlands: Author.
- Wargocki, P., Wyon, D.P., Matysiak, B. and Irgens, S. (2005) The effects of classroom air temperature and outdoor air supply rate on the performance of school work by children in *Proceedings of Indoor Air 2005*, vol. 1, pp. 368-372.
- World Health Organization (2016) *Preventing disease through healthy environments - A global assessment of the burden of disease from environmental risks*. Geneva, Switzerland: Author.

2 Knowledge transfer and transformation in the creative design process

Building a body of knowledge on climate-responsive design by itself does not guarantee proper implementation in newly designed dwellings. In fact, the opposite may be true when the knowledge is not available in the language of the one that has to work with the information. This chapter explores the form of the knowledge transfer and how to present the knowledge to the architect to stimulate successful implementation in the building design process.

The chapter starts with an observation of how designers think and work and elaborates on three relevant aspects: creativity, intuition and the use of visualisations. Followed by an observation of different learning styles that answer how to reach the architect with information. The next step is to gain insight in different design styles, whereas the activity of designing is not a normative set of actions to take but is highly shaped by personal style. A review of the creative design process then shows at what moments during the process that specific knowledge is needed. This knowledge will be gathered and generated in chapters 2 to 6. The actual transformation will be given shape in chapter 7.

§ 2.1 Introduction

Before the focus of this chapter will shift towards the transformation of specific knowledge of climate-responsive design to the expertise field of the architect, it is relevant to briefly discuss the considered direction of the knowledge transfer; the architect as the knowledge receiver.

A great deal of understanding climate design, and climate-responsive design in particular, is about physics: the laws of air movement, heat transfer in materials, etc. These physics are better understood and handled by (climate) engineers than architects. This might suggest that engineers are better in managing this specific part of design. However, climate-responsive design has more linkage to architecture (i.e. spatial design and materialisation) than it has to engineering which argues for execution by someone with design skills. Moreover, the architect is mostly also the one person that sets course for a final design. It is therefore essential that knowledge on climate-responsive design is understood by the architect. All the more because the environmental quality of final design occur during the early stages of the design process; typically the domain of the architect (Brown & DeKay, 2001; Yannas, 1989).

So, it will be helpful to both the architect and the engineer when the engineer's knowledge on climate-responsive building elements is translated into the 'language' of the architect and transformed into a form that best fit the different levels of detail typical for various design stages. Otherwise there is a risk that the architect might wrongfully implement the knowledge or even ignore it altogether. Therefore it is needed to know how the architect, as the receiver of specific knowledge, thinks and works. An accompanying issue is that there are different kinds of architects, each with their own style of designing. For starters it needs to be clear what kind of architects the specific knowledge on climate-responsive building elements is gathered for? These questions are to be answered in this chapter.

§ 2.2 How do designers think and work

With the architect as the initiator of design, knowledge on climate-responsive building elements need to be presented in such a way that it is both useful and usable for the architect. The presented knowledge is therefore best transformed to the architect's way of designing. This way of designing varies with the complexity of the design problem that will become better understood during the process. In the schematic phase or early stages of design the architect is predominantly working on finding a synthesis between his design ideas and all stated objectives (Cross, 1982). This process is merely interpretative and incorporates minimal analytical activities (Brown & DeKay, 2001). The form of the presented knowledge should address to this interpretative nature of the schematic design phase and connect to designer skills (Yannas, 1989).

There has been a lot of research conducted on how designers think and work. Three relevant aspects (creativity, intuition and visualisation) are discussed here briefly while they provide a background for the suggested knowledge transformation.

§ 2.2.1 Creativity in design

Creativity is the act of being creative and often considered to be a characteristic of a good designer. Creative behaviour induces new and original ideas which are needed to advance and cope with existing and new problems (Sternberg, 2005); not restricted to the field of sustainable design. But creativity is more than just being original, it is the ability to solve complex problems. Complex problems can be solved by using the unconscious mind, where creative ideas surface after a period of conscious thought or

action followed by a period of not consciously thinking about the problem (Dijksterhuis & Meurs, 2006). This is a skill that can be learned, by mastering the principles of lateral thinking (De Bono, 1970). It involves rearrangement of information in order to restructure existing patterns and creating new ones. A prerequisite of mastering that ability is by gaining knowledge and experience (Hertzberger et al., 1991, Lawson, 2005).

While the principles of climate-responsive design are not entirely new, discomfort and energy consumption are still two issues that are not successfully solved on a widespread scale in building design, and the design of dwellings in particular. This calls for creative solutions that elaborate on existing knowledge and good practice. This knowledge can be presented in many different levels of detail and complexity. Sustainable design knowledge transferred to the architect should not be too detailed while it may enable fixation of the architect on certain design solutions, and by doing so limiting his or her creativity (Callado-Ruiz & Ostad-Ahmad-Ghorabi, 2010). The knowledge should also not be too complex while it may be wrongly interpreted by the architect or ignored altogether.

§ 2.2.2 Intuition in design

Intuition is an immediate insight which lead to an opinion or a decision that is not always immediately validated by arguments. In the design process such mental images are a second steering mechanism in decision-making next to a methodological approach (Groeneveld, 2006) and its synergetic employment considered as one of the designers most important skills (Lawson, 2005). Groeneveld (2006) considers intuition as being gradually explored by the designer in the course of his life; not just necessarily in the architectural field. The author demonstrates a design method in which the designer's intuition is actively applied. By doing so the intuitive part of the design method becomes more effective which will be more beneficial in complex design situations, i.e. starting from abstract design problems.

However, it is not clear if the employment of intuition also leads to improved design outcomes in the field of sustainability. The opposite may be even true when the architect has anomalous notions of certain relevant design aspects which infects intuition. Anyway, the role of intuition in the design process is evident and undeniably important.

§ 2.2.3 Visualisations in design

Different forms of visual representation exist that assist in the development of the design or are used to communicate information during the design process. The visual style predominant in the early design stages is that of the sketch, a rough drawing, not more than an outline, of a design idea. Designers use these sketches to learn to understand the design problem (Menezes & Lawson, 2006). Thus, the use of sketches or conceptual visualisations appears to have a retroactive effect on the outcome of design. Sketching provides a way of visualising design ideas but in turn often enables the designer with triggers to evolve his design.

People read sketches differently. Interesting to tell is that during this research the author already started to explain the principles of climate-responsive design by showing sketches to architects, architecture students, engineers as well as researchers from the field of climate design and building physics. The variety of perceptions of what was presented in the sketches seemed large.

§ 2.3 How to reach the architect: learning styles

People perceive and process new information in different ways. Notion of different learning styles can give shape to specific knowledge transformations that are better received by certain types of architects. Kolb's (1984) learning style is a widely accepted approach and therefore presented here, for illustration purposes. Kolb's styles have two dimensions along which people perceive and process information (Figure 2.1). The two ends of the perception spectrum are concrete experience and abstract conceptualism. With concrete experience people recognize the information by seeing analogies in real life and from own experience, while with abstract conceptualism people think their way through the information. Both sides of the process spectrum are formed by active experimentation and reflective observation. When new information is received, people that are characterised by active experimentation understand the information by actively applying it to real situations. With reflective observation people study the information and reason towards understanding.

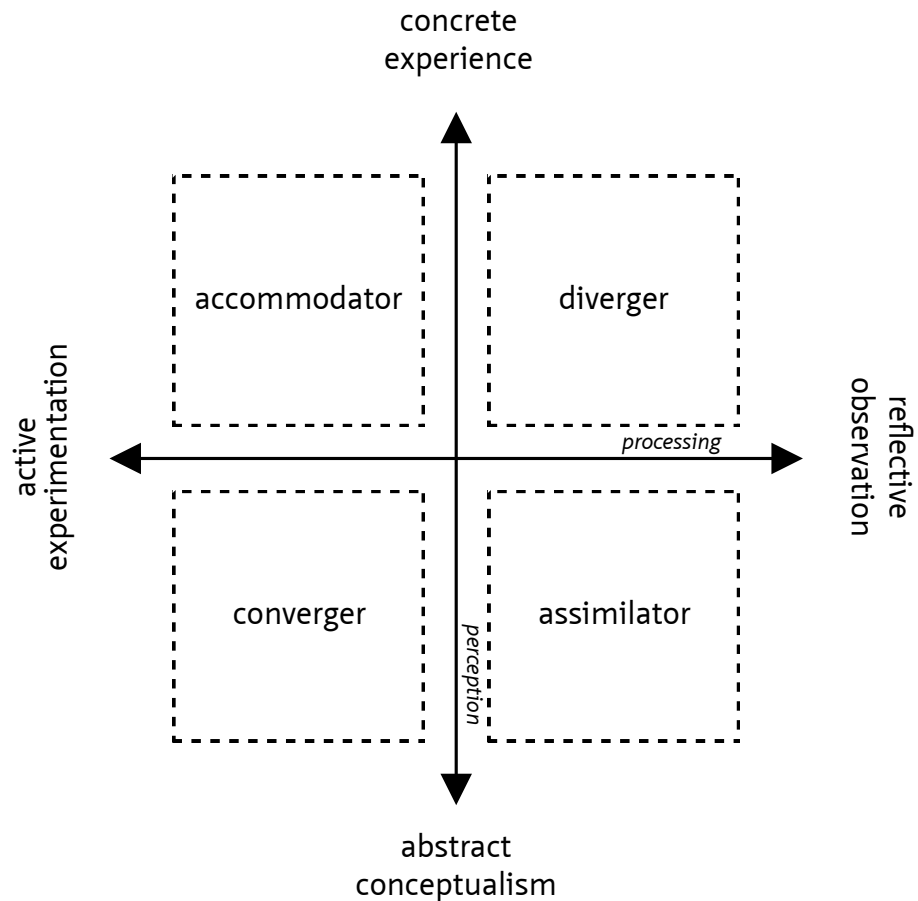

FIGURE 2.1 Kolb's styles of learning. Each quadrant represents a different preferred way to perceive and process new information. Adapted from Kolb (1984).

The learning styles also reveal different ways in stimulating architects to improve the outcome of their designs by introducing information on new techniques. For example, students are found in the abstract conceptualism end of the perception spectrum and find their way to the concrete experience end by doing and learning. Architecture students can be educated in innovative concepts of building design. They can be coached how to exert creativity in their future architectural practice. In the other end of the perception spectrum you find the practicing architects. Pioneers are able to use new techniques or design strategies in a heuristic approach, both solution-seeking and educational at the same time. Pioneers can be found in the accommodator quadrant of Kolb's learning styles. They know when and where to find specialists for assistance and their design process and its outcomes can be used as case studies for other projects. On the other hand, mainstream architects with less notion of sustainability rather design according to regulations and previous experience. These architects are found in the

diverger quadrant. They can only be moved to change their practice by new or more stringent regulations. Regulations that can be subtracted from the results achieved by the pioneers or in demonstration projects and research.

The majority of housing design in the Netherlands is realised in mainstream architectural practice. Since the aim of this research is the development of a design support tool with a focus on this group of architects, the support tool is best presented in a normative style.

§ 2.4 Styles in architectural design

There are different kinds of architects, each with their own style of designing. In a comprehensive study Van Bakel (1995) identified six distinct design styles deduced from a hierarchy in which designers prioritize one of three main design orientations or starting points: site, program and concept. The predominant design orientation is where the architect starts to look for a possible design solution. By doing so the architect limits the design problem and marks out the character of his design solution (Darke, 1979).

With site orientated design the features of the building site (e.g. location, orientation, scenery, urban plan, etc.) are the primary factors in decision-making during the design process. With program orientated design the issues stated in the design brief (e.g. time, budget, client, use, etc.) determine the direction of the end-result. Finally, with concept orientated design the architect's design idea is the main driving force to a final design. A first selection of possible design solutions based on the primary design orientation is then narrowed down when they are assessed to the rules that come from the secondary and tertiary design orientation.

The six identified distinct styles are pragmatic, syntactic, iconic, analogic, convergent and feasibility. A short description of each of these design style is given in [Table 2.1](#), as well as the corresponding hierarchy of design orientations.

STYLES	DESCRIPTION	HIERARCHY OF DESIGN ORIENTATIONS
pragmatic	The pragmatic design style starts from available materials and resources to generate a building with a satisfying indoor climate. A design solution is found by trial and error starting from existing building environment and the performance as stated in the design brief.	site, program, concept
syntactic	The syntactic design style leads to the exploration of geometrical aspects of space and elements which become the rules that determine the final design.	program, site, concept
iconic	With the iconic design style the final design clearly arises from an abstract image that the architect comes up with. This image can be traced back to skills and intuition and result in designs that carry the architect's signature.	concept, program, site
analogic	The analogic style of designing refers to architects that derive new forms from existing ones by analogous thinking. This existing forms are often based on forms from other (non-architectural) fields.	concept, site, program
convergent	The convergent design style starts from the site which sets the rules that lead to the generation of different design concepts. The final design is chosen in accordance with the design brief.	site, concept, program
feasibility	With feasibility style of designing the performance is taken as the starting point and set the rules for the possible conceptual design solutions.	program, concept, site

TABLE 2.1 The six distinct architectural design styles and the corresponding hierarchy of design orientations (after Van Bakel, 1995).

Most relevant to this research is not so much the different design styles but the three design orientations that function as the starting point because they steer towards a certain transformation of knowledge. For example, architects that start designing from the site first explore the building's environment to determine what can be harvested from it. A structured overview of possible design solutions to harvest those natural offers might be helpful to such an architect. Architects that take the program or design brief as the starting point benefit most from quantitative information that allow a quick assessment of different design solutions to meet stated requirements. Finally, architects that start from a design idea could benefit from a highly visual approach of possible design solutions that show how they affect the design.

The most common design style in mainstream housing design is probably the syntactic style where the architect starts from satisfying the program. More preferable for climate-responsive design is a pragmatic or convergent design style starting from the site. Although architects can start off from clearly different onsets, a satisfying final design outcome is only achieved when each orientation is taken course. This mutuality in design where all three orientations will come across calls for cross-linkage of the information.

§ 2.5 The creative design process

Any design process starts with a problem or a need to which a solution is to be found. There are different ways to tackle this problem. Well known in the field of architecture is the “Pattern Language” (Alexander et al., 1977). The language is formed by a set of patterns, each describing a problem, and a solution to every pattern. A more general approach to problem-solving in a creative design process has been captured in numerous models. Howard et al. (2008) compared a large number of models in literature and derived a general four-phase process (Table 2.2), consisting of the following four phases:

- **Analysis**
the exploration of possibilities and limitations
- **Generation**
the actual process of conceptual design with the generation of design options; valid solutions to the problem (or need)
- **Evaluation**
evaluation of design options
- **Communication or implementation**
the selection of the preferred design option and the basis for the final design

Although often considered linear, these four phases are combined in a dynamic process. The process can only be linear when all requirements are noted in a design brief. In reality this is hardly the case and the conceptual design task involves the definition and modification of the design task (Gero & Kannengiesser, 2004).

MODELS	ANALYSIS PHASE				GENERATION PHASE			EVALUATION PHASE	COMMUNICATION / IMPLEMENTATION PHASE		
Helmholtz (1826)	Saturation				Incubation	Illumination	-	-	-		
Dewey (1910)	A felt difficulty	Definition and location of difficulty			Develop some possible solutions			Implications of solutions through reasoning	Experience collaboration of conjectural solution		
Wallas (1926)	Preparation				Incubation	Illumination	Verification	-			
Kris (1952)	-				Inspiration			Elaboration	Communication		
Polya (1957)	Understanding the problem	Devising a plan			Carrying out the plan			Looking Back	-		
Guilford (1957)	-				Divergence			Convergence	-		
Buhl (1960)	Recognition	Definition	Preparation	Analysis	Synthesis			Evaluation	Presentation		
Osborn (1963)	Fact-finding				Idea-finding			Solution-finding	-		
Parnes (1967)	Problem, challenge, opportunity	Fact-finding	Problem-finding		Idea-finding			Solution-finding	Acceptance-finding	Action	
Jones (1970)	Divergent				Transformation			Convergent	-		
	Search for data		Understand the problem		Pattern finding	Flashes of insight		Judgement			
Stein (1974)	Fact-finding				Hypothesis formulation			Hypothesis testing	Communication of results		
Parnes (1981)	Mess finding	Problem-finding			Idea-finding			Solution-finding	Acceptance-finding		
Amabile (1983)	Problem or task presentation	Preparation			Response generation			Response validation	Outcome		
Barron and Harrington (1981)	-				Conception	Gestation	Parturition	-	Bring up the baby		
Isaksen et al. (1994)	Constructing opportunities	Exploring data	Framing problem		Generating ideas			Developing solutions	Building acceptance	Appraising tasks	Designing process
Couger et al. (1993)	Opportunity, delineation, problem definition		Compiling information		Generating ideas			Evaluating, prioritising ideas	Developing an implementation plan		
Shneiderman (2000)	Collect				Create			Donate (communicate)			
					Relate						
Basadur et al. (2000)	Problem finding	Fact finding	Problem defn.		Idea finding			Evaluate and select	Plan	Acceptance	Action
					Diverge – converge at each stage						
Kryssanov et al. (2001)	Functional requirements		Structural requirements		Functional solutions	Analogies, metaphors	Reinterpretation	-			

TABLE 2.2 A comparison of creative process models (Howard et al. 2008).

Due to its complex character the design puzzle will have typically more than one suitable outcome. All of these design options are subject to boundary conditions, a set of design objectives and constraints, determined by legislation or client demand. In climate-responsive design the main objective is the generation of a satisfying (and functional) indoor environment by harnessing the energy potential of the local environment (Figure 2.2). The boundary conditions of the design can bound the usage of the energy potential of the local environment.⁸ These conditions include restrictions on comfort, accessibility, functionality, safety and sustainability, among others. Some of these conditions are defined in regulations and are legally binding. Other conditions are set by the clients and may be negotiable. As comfort is the primary aim of climate-responsive design, the comfort demands encompass the final set of design options. When the principal or design team is more ambitious they can bring the comfort demands to a higher level by setting a goal. This will further narrow down the amount of design options. The final design is the selected design option that best suffices secondary design objectives such as finances, performance and architecture.

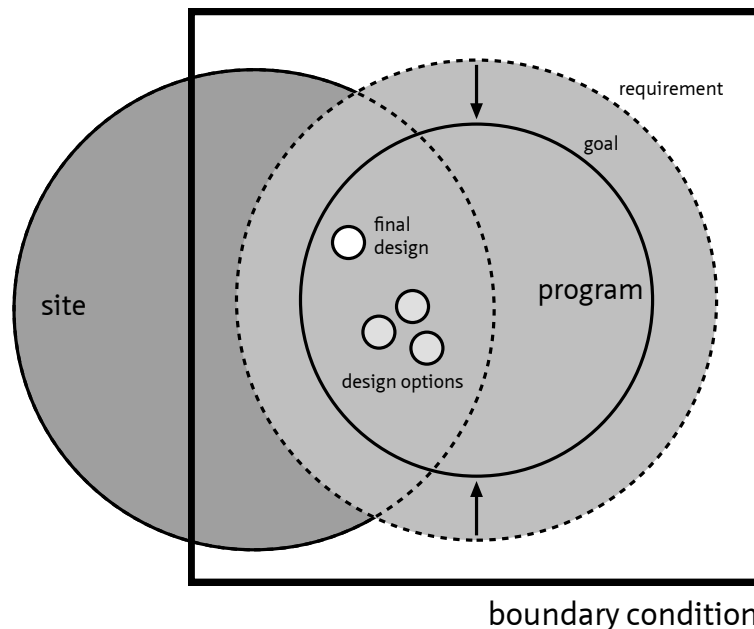

FIGURE 2.2 Schematic representation of possible design options within the set of objectives and constraints in climate-responsive design.

8

For example the Water Act may prohibit the exploitation of the energy potential of groundwater and nearby surface water. Other examples are acts on preservation of monuments and district heritage which may generate limitations to the visual appearance of the building, and thus to the application of more visible design solutions.

§ 2.6 Conclusion

The design process is a highly complex task. Architectural design has to meet a variety of objectives that heavily interrelate with each other. With climate-responsive design the challenge is to create comfortable and healthy indoor environments by mixing and matching multiple design solutions. Hereby the process becomes even more complex. Creativity and high levels of expertise are required to generate a satisfying result. Although experts can be introduced to the design process, in practice specific expertise is sparsely used or can often not be called upon during the early design stages of analysis and concept development (Kanters et al., 2014). This means that the architect needs to make these decisions on his or her own. In order to do so the architect needs sufficient information on the basics of climate-responsive design, provided as informative support when making his or her decisions.

The knowledge that feeds the information needs will be gathered and generated in the upcoming 4 chapters, split into two parts. The first part starts with an analysis of comfort and energy demands of climate-responsive design in chapter 3, followed by the quantification of the climate potential of the built environment in chapter 4 to meet those demands. The outcomes of chapter 3 and 4 lay the foundation of the second part starting with chapter 5, which elaborates on the fundamentals of climate-responsive design and gives an overview of identified climate-responsive building elements. In chapter 6 relevant knowledge on climate-responsive building elements is presented. The actual transformation will be given shape in chapter 7.

References

- Alexander, C., Ishikawa, S. & Silverstein, M. (1977) *A pattern language: Towns, buildings, construction*. New York : Oxford University Press.
- Brown, G.Z. and DeKay, M. (2001) *Sun, Wind and Light - architectural design strategies* (2nd edition). New York: John Wiley and Sons, Inc.
- Collado-Ruiz, R. and Ostad-Ahmad-Ghorabi, H. (2010) Influence of environmental information on creativity in *Design Studies*, vol. 31, issue 5, pp. 479-498.
- Cross, N. (1982) Designerly ways of knowing in *Design Studies*, vol. 3, issue 4, pp. 221-227.
- Darke, J. (1979) The primary generator and the design process in *Design Studies*, vol. 1, issue 1, pp. 36-44.
- De Bono, E. (1970) *Lateral thinking: A textbook of creativity*. London, England: Ward Lock Educational.
- Dijksterhuis, A. and Meurs, T. (2006) Where creativity resides: The generative power of unconscious thought in *Consciousness And Cognition*, vol. 15, issue 1, pp. 135-146.
- Gero, J.S. and Kannengiesser, U. (2004) The situated function-behaviour-structure framework in *Design Studies* 25, pp. 373-391.
- Groeneveld, R.P. (2006) *De innerlijke kracht van de ontwerper - de rol van intuïtie in het ontwerpproces*. Rotterdam, The Netherlands: Veenman Drukkers.
- Hertzberger, H., Ghait, L., and Rike, I. (1991) *Lessons for students in architecture*. Rotterdam, The Netherlands: Uitgeverij 010.
- Howard, T. J., Culley, S. J. and Dekoninck, E. (2008) Describing the creative design process by the integration of engineering design and cognitive psychology literature in *Design Studies* 29, pp. 160-180.
- Kanters, J., Horvat, M. and Dubois, M.-C. (2014) Tools and methods used by architects for solar design in *Energy and Buildings*, Volume 68, Part C, January 2014, Pages 721-731.
- Kolb, D.A. (1984) *Organizational Psychology: an experimental approach to organizational behaviour*. New Jersey: Prentice Hall.
- Lawson, B. (2005) *How Designers Think - the design process demystified* (4th edition). Oxford, England: Architectural Press.
- Menezes, A. and Lawson, B. (2006) How designers perceive sketches in *Design Studies*, vol. 27, issue 5, pp. 571-585.
- Sternberg, R.J. (2005) Creativity or creativities? in *International Journal of Human-Computer Sciences*, vol. 63, pp. 370-382.
- Van Bakel, A.P.M. (1995) *Styles of architectural designing: empirical research on working styles and personality disposition*. Eindhoven, The Netherlands: Technische Universiteit Eindhoven.
- Yannas, S. (1989) Physics and architecture. Issues of knowledge transfer and translation to design in *Solar & Wind Technology*, vol. 6, issue 4, pp. 301-308.

3 Comfort and energy demand of dwellings

The main objective of building design is to provide healthy and comfortable indoor environments, in which humans can work, dwell or perform any other activity that contributes to their well-being. The creation of such environments is of course complemented by spatial, aesthetical, functional, economical and sustainable factors. What is defined as comfortable has far-reaching implications for the way buildings are designed and how they are operated, which in its turn gives an indication of the energy used for maintaining a comfortable indoor environment.

This chapter provides both general knowledge and state-of-the-art insight in the design of comfortable buildings and the consequences for the building's energy demand. It presents recent views on health and comfort delivery that include the human preference for diversity and moves away from the static conditions that rule comfort definitions nowadays. It also explains how we meet comfort related energy demands in buildings today and suggests that the way to go from there is to benefit from the abundant supply of renewable energy sources. This chapter concludes with an elaboration on the relevant boundary conditions (spatial, functional and comfort-related) and their impact on the energy concept of a design.

§ 3.1 Health and comfort in buildings

We control the indoor environment to our needs by the delivery of different building services such as heating, cooling, ventilation, lighting and domestic hot water, typically established with aid of mechanical systems. This can be explained from the traditional idea that meeting user needs on comfort could be met by the creation of a static, ideal thermal environment. In this section comfort is regarded in the broader perspective of human well-being and is considered from a user perspective rather than from the perspective of energy-savings.

§ 3.1.1 Well-being

Human well-being is commonly described in terms of health, comfort and happiness. The World Health Organisation uses the following definition of health (World Health Organisation, 2014):

“Health is a state of complete physical, mental and social well-being and not merely the absence of disease or infirmity.”

Comfort in the context of building design is often explained as a state of mind which reflects the physiological human condition of an experienced environment. Happiness comprehends the psychological condition of on-going or predominant well-being. These three aspects, health, comfort and happiness, are obviously heavily interrelated. Moreover, lasting discomfort or unhappiness can be a threat to health.

To clarify their mutual position, health, comfort and happiness can be considered in a range from disease or direct measurable health issues (e.g. blood pressure, body temperature) to non-measurable aspects of happiness (e.g. satisfaction, beauty, quality) (Steemers, 2009). In this spectrum, comfort lies in-between, on the border of quantitative and qualitative parameters (Figure 3.1).

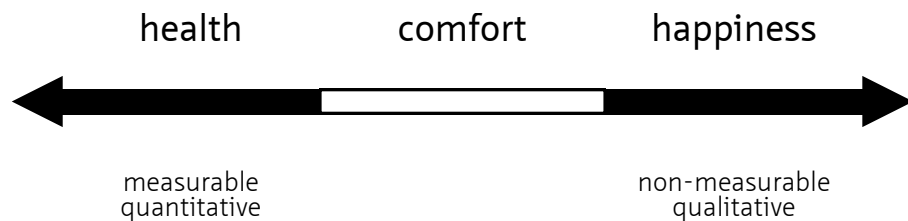

FIGURE 3.1 The position of health, comfort and happiness in a well-being spectrum. Adapted from Steemers, (2009).

Healthy environments have limited contaminations and minimise exposure to physical, chemical and biological risk factors. People in the Netherlands spend on average 85% of their time indoors (European Environment Agency, 2013). On average, little over 16 hours a day we spend in our homes (Bluyssen, 2013). The protective character of buildings plays an important role in keeping contaminations out. At the same time that protection may also cause contaminants produced from human activity or from used (building) materials to be retained indoors (Bonney, 2007). Building design is therefore an influential factor in the creation of healthy indoor environments. Even though different strategies can guarantee a healthy indoor environment, it may be evident that contaminations should primarily be tackled at their source.

Comfort provision and the preference for diversity

Comfort knows many facets where it touches some of the physiological ways of perception; our senses. It includes thermal, visual and acoustical aspects. The provision of comfort means as much as keeping certain comfort levels and the avoidance of discomfort. Therefore, comfort is not so much bounded by strict rules but can be described in terms of a comfort zone. The boundaries of this comfort zone are set by physiological, experiential and social factors (Shove, 2004). These three factors have different consequences for the practical implementation of comfort in building design and the control of the indoor climate.

Human comfort is subjective and based on the evolutionarily developed ability of humans to adapt themselves to changing environments and to adapt these environments to their needs. Comfort provision is a dynamic process under the influence of environmental conditions and human interaction. Humans play an important role in creating their own satisfying environment (Baker & Standeven, 1996; Bordass et al., 1993). The possibility to manage one's personal environment broadens the window of acceptance (Brager et al., 2004; Nicol & Humphreys, 2002; Shove, 2004). The absence of comfort is not an immediate threat to health. On the contrary, small deviations from what is the current standard imply certain health benefits (Van Marken Lichtenbelt et al., 2014). Moreover, diversity should be celebrated. It stimulates our senses and provides an interaction with the outdoor environment (Baker, 2004; Heschong, 1979). How to cope with the subjectivity of comfort perception in building design is covered in the section 3.1.5 the user in control.

§ 3.1.2 The thermal indoor environment

What is defined as comfortable has far-reaching implications for the way buildings are designed and how indoor environments are maintained. The creation of a comfortable thermal environment is perhaps the most complicated, since it is defined by the combination of many factors. The four environmental variables that affect thermal comfort are: air temperature, air movement, air humidity and heat radiation (Szokolay, 2008). In this section the thermal indoor environment is considered into more detail; starting off with thermal comfort and accompanied by two heavily related aspects: indoor air quality and visual comfort. Since the aim here is to highlight to what extent a comfortable thermal indoor environment can be met in conjunction with the dynamics of the built environment, the study is predominantly qualitative.

Thermal comfort is often considered as the driving force on which many comfort-related design solutions are based. The challenge to meet user needs was met by the definition of 'ideal' thermal environments (which could be easily established with aid of mechanical systems) that were determined from physiological behaviour of humans in static thermal conditions.

Metabolism and the thermal balance of the human body

Metabolism is the on-going process of the human body in order to grow, recover and adapt to changing environments. Basically it consists of two steps: catabolism and anabolism. With catabolism the human body harvests vital nutrients (e.g. carbohydrates) from food and beverages. It is succeeded by anabolism in which these nutrients are used to generate new components (e.g. proteins) in the human body.

During this metabolic regulation the body produces heat which varies from 70 W for a human asleep to 700 W at intense exercise. The metabolic rate is therefore also used as a measure to indicate the rate of heat production. If this heat is not carried away, body temperature will rise and can cause serious damage to the body.

Fortunately the human body is homeothermic, which means that it can regulate its own heat balance. When the human body experiences discomfort the initial controlling mechanism is the alteration of the blood flow to the skin. When it is too cold, the blood flow will drop and skin temperature and heat dissipation will reduce. This adjustment mechanism is called vasoconstriction. If this mechanism is not sufficient, the body starts to shiver; a non-controllable muscle activity that increases the heat production drastically. Ultimately, hypothermia will occur with a chance of serious harm to the human body. The contrary, vasodilation, occurs when the body gets too hot. Blood flow will increase and so will the skin temperature and the heat dissipation. If not sufficient, the production of sweat starts which supplies the body with evaporative cooling. A final stage of hyperthermia runs a risk of body damage.

To what level the human body can regulate its own heat balance depends on its state (e.g. health, body shape, body fat, age and gender) and on some personal factors (e.g. clothing and adaptive behaviour). In addition, some environmental factors are relevant too. Environmental factors that influence thermal comfort are air temperature, air movement, humidity and radiation from inner surfaces. These are of more importance to designers because they are strongly influenced by building design.

Traditional comfort standards

Since the introduction of indoor climate control systems thermal comfort is traditionally defined as a state of balance between heat production and dissipation; the heat balance model. This approach forms the basis for traditional comfort standards,

based on thermal comfort models developed by Fanger (1970). His comfort model is based on the field experience of humans exposed to static conditions in controlled indoor climates and assumes that comfort is established only when the human thermal balance is in equilibrium. This resulted in a comfort standard with strict temperature ranges in which the indoor temperature may vary only slightly in order to maintain a certain level of comfort. It also led to a universal definition of thermal comfort independent of climate, culture and building type. In other words any person should experience similar comfort in any building anywhere in the world as long as the indoor climate is controlled within certain limits.

The adaptive approach

Recently, a growing number of studies opt for a swing towards an adaptive approach in which comfort is subject to changed perceptions as a result of adaptive ability of human beings (Brager & De Dear, 1998) and should take cultural and social factors into account (Shove, 2004). Within the adaptive approach three distinct types of adaptation are identified: physiological, psychological and behavioural.

Physiological adaptation covers the adaptive ability of the human body itself. It has a long-term component that is culturally decided and can vary with gender and age, and a short-term component that depends on experienced weather in the recent past. Practical implementation of the long-term effect is that people in warmer climates perceive higher temperatures and wider variation as being comfortable opposed to people in colder climates. The short-term effect deals with the slow adaptation of the human body to a new situation as for instance the weather changes during heat waves or if one moves from one climate to another.

Psychological adaptation comprehends past experiences and future expectations of indoor climate. Whether or not a person feels comfortable in a certain environment is partly influenced by attitude, preference and expectations. Shove (2004) poses the interesting question whether addressing the comfort issue by meeting people's needs (on thermal comfort) will result in the creation of certain indoor environments that in turn steer these needs in a certain direction, possibly away from the underlying cultural or social needs.

Behavioural adaptation involves all abilities of occupants to exert influence on their personal environment by opening windows, lowering blinds or moving to other spaces. With the ability of doing so people become more tolerant to deviations and variations in their thermal environment (Brager et al., 2004; Nicol & Humphreys, 2002).

Adaptive comfort standards in the Netherlands are deduced from these insights and set limits to comfortable indoor temperatures as a function of multi-day ambient temperature development (ISSO, 2004; Van der Linden et al., 2006). [Figure 3.2](#) shows

comfortable indoor operative temperatures as a function of the running mean outdoor temperature for building that have a high degree of adaptive capabilities (e.g. separate thermal zones, individual control and operable windows). The boundary conditions of accepted temperature swings depend on the level of acceptance, indicated by the predicted percentage of dissatisfied (PPD). The upper limits of the comfort zone show an increased acceptance of elevated indoor temperatures with persistent high ambient temperatures.

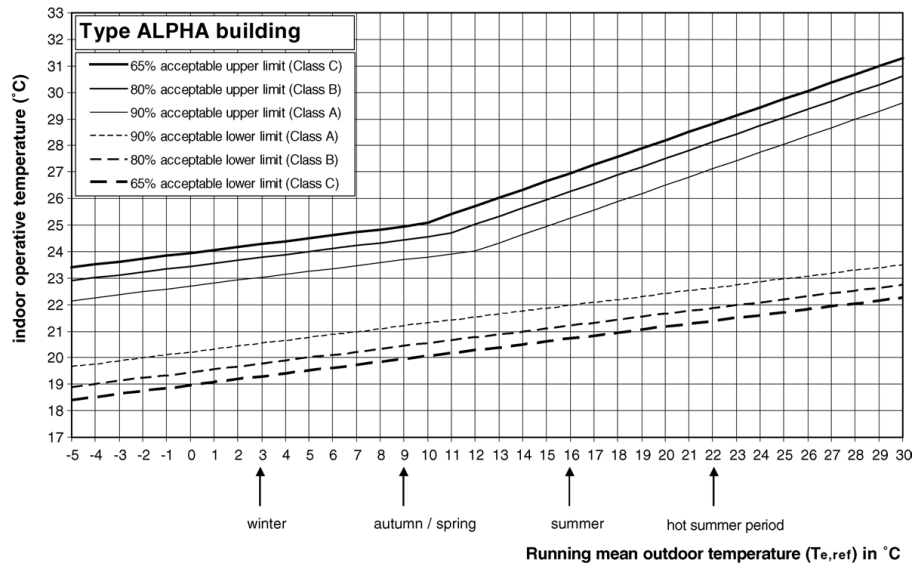

FIGURE 3.2 Adaptive comfort temperature limits as a function of the running mean outdoor temperature for different levels of acceptance. These values are valid for buildings with a high degree of adaptive capabilities (e.g. separate thermal zones, individual control and operable windows). It can be seen that the acceptance of elevated indoor temperatures is higher with persistent increased ambient temperatures. Reprinted from Van der Linden et al. (2006).

These standards are valid for office environments. There are no adaptive comfort standards defined specific for dwellings, still some dedicated research on this topic has been conducted. Kurvers et al. (2008) remarks in their literature review on demand control and indoor environment that comfort in dwellings is more subject to the different types of adaptation. Therefore, the acceptance of elevated temperatures is also higher. Peeters et al. (2009) submits that conditions in dwellings are not quite comparable to office spaces, whereas domestic activities vary constantly, and proposes a distinction between three different thermal zones: bathroom, bedrooms and other habitable rooms. The relevance of distinct comfort standards for dwellings can also be found in reported differences in thermal sensation of similar activities performed in climate chambers, offices and homes (Oseland, 1995).

All these adaptive mechanisms tend towards an indoor thermal environment that is more in tune with the outdoor environment. Use the beneficial forces from the outdoor environment and manage the energy flows in order to fit comfort needs.

§ 3.1.3 Indoor air quality

The level of indoor air quality is determined by the amount of contaminants in the (indoor) air and can have a severe impact on human health and comfort. There are numerous contamination sources. According to their origin they can be divided into the following two types: building construction related and building occupation related (Figure 3.3).

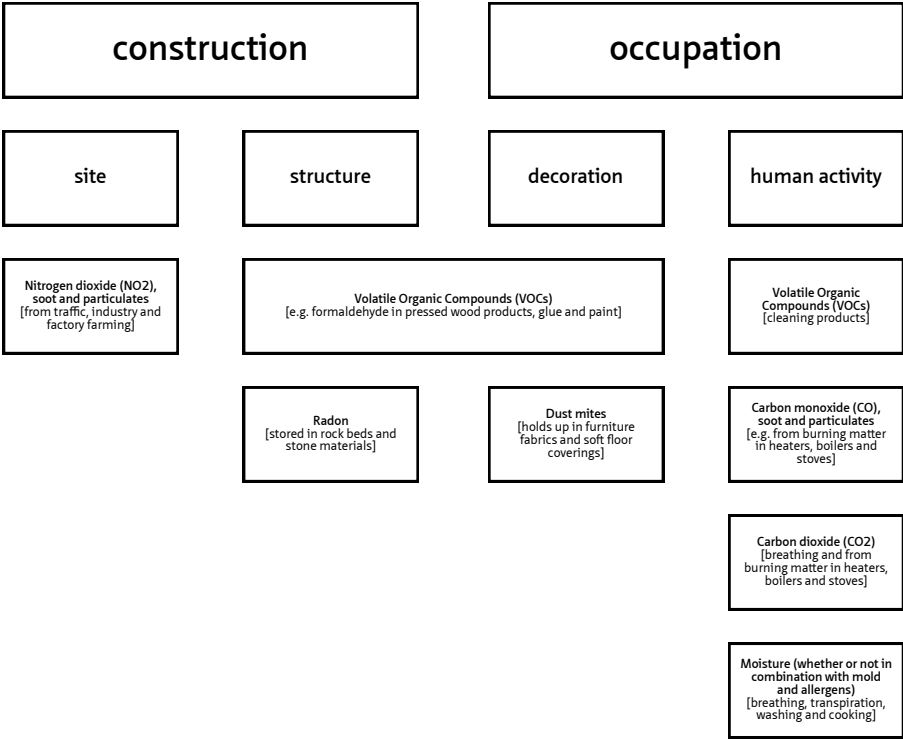

FIGURE 3.3 Common contaminants and their sources that endanger indoor air quality.

Building construction related contaminants are added to the indoor environment after the erection of buildings and can be split into contaminants concerning the building site and the building structure. Contamination sources from the site include pollution from nearby traffic and from industry and factory farming. Most common pollutants are nitrogen dioxide (NO₂), soot and particulates (Volkshuisvesting, Ruimtelijke Ordening en Milieubeheer, 2010). Contaminants related to the building structure are nested within used building materials and are released to the indoor air over a certain period of time. Most common contaminants embedded in building materials are volatile organic compounds and radon.

The second and often inevitable source of contamination is the result of occupation. Common contaminants are volatile organic compounds, carbon monoxide, carbon dioxide, water vapour and house dust mites (Jongeneel et al., 2009). Volatile organic compounds form a collection of organic chemical compounds that easily vaporize at normal conditions and are used in many products (e.g. furniture, paint and cleaning products). Some of those VOCs cause health issues when inhaled. Carbon monoxide (CO) is a common by-product of burning matter with limited oxygen supplies. Just like carbon dioxide (CO₂) it is produced in gas-fired or wood-burning heaters, boilers and stoves and is not noticeable by humans because it has no colour and no smell. CO is a serious threat to human health because through inhalation it rapidly displaces the oxygen in blood vessels and by doing so it poisons the organ systems that depend on oxygen (i.e. central nervous system, heart and brain). CO₂ is also produced by humans while breathing and displaces healthy oxygen levels in the air. Water vapour is also produced when humans breathe. Other sources are human transpiration and household activities like cooking and washing. While high humidity levels can worsen complaints about respiration, they also provide ideal circumstances for many organic contaminants or molds. Finally, house dust mites are microscopic organisms that can particularly be found in beds, furniture and soft floor covering. They are a common cause for allergic reactions.

Basic ventilation needs

Many contaminants can be prevented by carefully choosing the building site and proper building systems and by using non-contaminated building materials. In addition, contaminants can be removed from the indoor environment through sufficient ventilation. However, building construction related contaminants should be prevented or eliminated as much as possible. They carry unnecessary health risks and by elimination limited ventilation is required when the building is unoccupied. Building occupation related contaminants from human activity need to be removed from the indoor environment through sufficient ventilation, preferably demand controlled, and from regular cleaning (De Gids et al., 2012).

A human being needs about $0.2 \text{ dm}^3/\text{s}$ of air in order to be able to take enough oxygen from it. In order to remove contaminants Dutch building requirements set a minimum continuous ventilation need of $0.9 \text{ dm}^3/\text{sm}^2$, with a minimum of $7.0 \text{ dm}^3/\text{s}$, for habitable rooms when staying indoors for longer periods. These numbers are in accordance to the current Dutch standard NEN 15251 (2007) with the remark that vulnerable people (i.e. sensitive people, sick people, young children, elderly) need 40% more ventilation. However, depending on the amount of pollution from the building itself 40% to 110% higher ventilation rates are recommended for office spaces.

With ventilation, fresh air is drawn in from outside. Although that air contains pollutants as well, the indoor air quality will generally improve through ventilation with outside air. Natural ventilation is the logical choice here but attention must be paid so that the chosen design solution meets the requirements. The effectiveness of natural ventilation is determined by design and layout. In fact, sufficient ventilation can be guaranteed and therefore most of the health risks can easily be eliminated through proper design. Here lies a responsibility for the architect.

§ 3.1.4 Visual comfort

Light operates in the whole spectrum of well-being; from health to happiness. Bad lighting conditions cause visual discomfort and can even become a health risk. This is especially valid when performing so-called visual tasks (e.g. reading, writing, computer-based tasks and assembly works). The absence of sufficient light tires the eyes and brain and the exposure to extreme light intensities causes distraction and disturbance. The other side of the spectrum is filled by light design as a quality of architecture. Architectural qualities such as space and form and material characteristics such as texture and colour are revealed through light. Moreover, light can be manipulated by architecture.

The most common sources of light are thermal sources and include the sun, fire and electrical lighting appliances. The visual spectrum or luminous flow is that part of emitted electromagnetic radiation that is visible to the human eye. Important phenomena in the experience of light and vision are brightness, contrast and shadow casting which are defined by four performance indicators: illuminance, distribution, direction and glare. However, the mapping alone of these performance indicators does not simply tell us how people perceive the visual quality of a space. Other aspects such as diversity, quality of view and freedom of choice play an important role in the perception of visual comfort as well (Hellinga, 2013; Parpairi, 2004).

Sunlight is vital to all living organisms and has considerable effect on human well-being. The ultraviolet beams of natural light are essential for the production of vitamin D in human skin. Light is also the main stimulator for the human biorhythm, the natural trend in human physiological behaviour. Moreover, the absence of (natural) light in tune with the daily cycle contributes to seasonally affective disorder (SAD). The dynamics of natural light also have a stimulating effect. Daylight provides a surrounding source of light from a broad spectrum of colours and its dynamics give information on time of day and weather conditions. Moreover, daylight is generally appreciated as more comfortable than artificial light.

Daylight admission in buildings is typically guaranteed from the use of windows. Another essential function of windows is to provide occupants with a view to the outside world; being an important source for information (Boyce et al., 2003). This is inextricably connected to the reciprocal effect of being watched from the outside. Depending on personal preference, partially based on cultural differences, this may be in conflict with privacy.

However, light has not only a relation to visual expression and health issues but also has a strong link with the thermal environment. Light means energy. When sun rays are absorbed in (building) mass, light is transformed into heat. The radiated heat directly affects air and surface temperature and by doing so it influences thermal comfort. When light, heat, air and their relation to comfort are controlled flawlessly and in tune with the outdoor environment this will reduce energy consumption and dependency on artificial systems.

§ 3.1.5 The user in control

The function of a dwelling is determined by the individual, shaped through personal experience and cultural background. Being able to dwell is not only limited to the building itself but also to a great extent to its surroundings, spanning different scale levels (e.g. street, district, city or country), and can change in time, or with the zeitgeist (e.g. urbanisation, smaller households, the office at home) (Leupen & Mooij, 2008). In other words, people use a house in many different ways which will result in different comfort needs.

However, in many housing projects the commissioner is a property developer or a housing association, not the future occupant itself. In these cases, as a designer of dwellings, the architect is practically unknown to the people that actually come to live in the dwelling and therefore does not know how the design is eventually used as a dwelling. Moreover, in time some residents will move out and be replaced by new individuals that have other comfort needs. An ideal home should facilitate this individual way of turning a building into a home. But how to cope with such uncertainties?

The obvious thing to do in order to meet personal perception and preference of comfort by people is to let them be in charge of controlling their own environment. The idea of people in charge of controlling their own environment will lead to comfortable environments in more than one way. Beside the fact that a user in control can adapt the environment to suit its personal needs best, people also have a wider range of thermal conditions in which they feel comfortable when given the opportunity to take measures to alter their environment. Since dwellings typically accommodate a small group of people the concept of the user in control is quite appropriate here.

This scenario of the user in control can only work within certain boundary conditions. When a user wants to exert influence over its environment its actions should lead to a desired and expected change in comfort. This behaviour needs to be facilitated by the building itself (e.g. the ability of moving between spaces) and complemented by the used comfort systems that control the indoor environment in a more tailored way.

§ 3.2 Energy demand of Dutch dwellings

We use buildings to provide ourselves with a comfortable and healthy environment in which we can dwell, work or relax. With buildings we create an indoor environment that is less severe than the outdoor environment. Buildings keep out precipitation, strong winds and excessive solar radiation and keep a comfortable indoor temperature and provide us with fresh air. The creation and continuance of a comfortable indoor environment requires energy.

§ 3.2.1 Development of energy demand of Dutch dwellings

Energy demand is heavily set by energy performance regulations that over the past years have become and in the future will become more stringent. Figure 3.4 shows the calculated annual gas demand for space heating in a typical new Dutch dwelling specific for the stated year. The calculated gas demand for space heating has dropped with more than 90% in 40 years. These numbers depict theory. In practice the drop is less dramatic. Research shows that the gas demand for space heating for dwellings with a poor energy performance is overestimated with almost 100%, and underestimated for dwellings with a high energy performance with roughly 20% (Majcen, 2016).

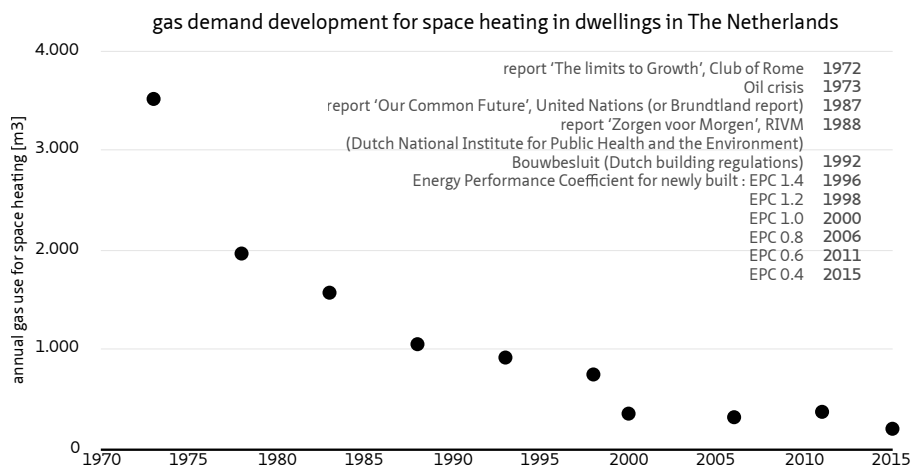

FIGURE 3.4 The development of (calculated) annual gas demand for space heating for a typical new mid-terraced dwelling. Adapted from Klimapedia (2015).

This was achieved from early reductions on component level (e.g. increased insulation levels and improved air tightness of the building envelope), followed by improvements on system level (e.g. increased efficiency of building systems). This may seem as quite an achievement, but it only shows a part of the whole picture. [Figure 3.5](#) and [Table 3.1](#) show the calculated energy demand of typical newly built mid-terraced dwellings in the Netherlands in 2006, 2011 and 2015. The dwellings' shape, layout, architectural measures and installations are considered as common practice following the Dutch standards on energy efficiency in 2006, 2011 and 2015⁹ (Agentschap NL, 2013; Rijksdienst voor Ondernemend Nederland, 2015; SenterNovem, 2006).¹⁰ The dwelling size, form, layout and position of openings don't vary throughout the years, but the thermal resistance of different parts of the building envelope and the applied technical systems do. The design can be seen as a schematic representation of the standard in current and expected building design in the Netherlands at that time.

9 The energy performance coefficient (EPC) dropped from 0.8 in 2006 to 0.6 in 2011 and was further reduced to 0.4 in 2015. The calculation method of the energy performance coefficient was prescribed in the standard NEN5128 since 2004 and replaced by NEN7120 in 2011.

10 Since 2010 SenterNovem operates under the hood of Agentschap NL (NL Agency), an agency of the Dutch Ministry of Economic Affairs that implements government policy for sustainability, innovation, and international business and cooperation. In 2014 Agentschap NL merged into Rijksdienst voor Ondernemend Nederland (Netherlands Enterprise Agency).

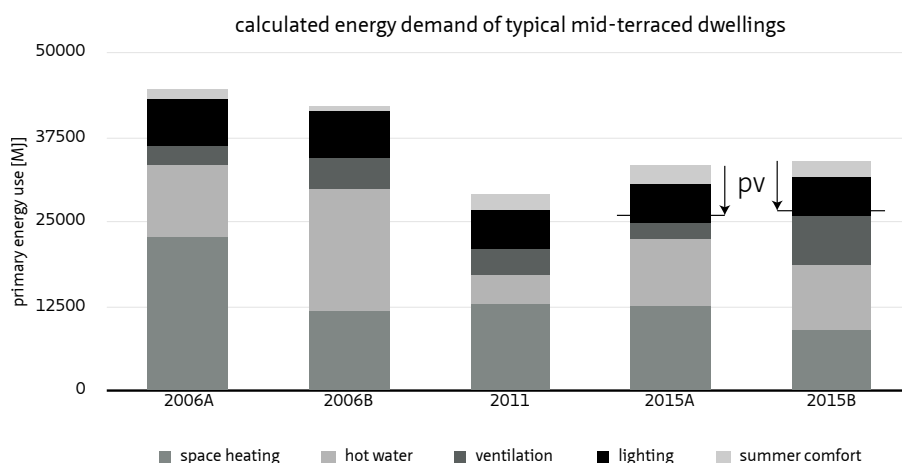

FIGURE 3.5 Calculated Building-related energy demand of typical mid-terraced dwellings in the Netherlands in 2006, 2011 and 2015. Note that the energy demand for summer comfort is a fictive demand that quantifies measures to prevent overheating in summer. No active cooling system is installed. The whole yield of the PV system diminishes the primary energy use and thus improves energy performance, although electricity production exceeds building related energy consumption.

	2006A	2006B	2011	2015A	2015B
R_c opaque façade	3.0 m ² K/W	3.0 m ² K/W	3.5 m ² K/W	4.5 m ² K/W	4.5 m ² K/W
R_c roof	4.0 m ² K/W	4.0 m ² K/W	4.0 m ² K/W	6.0 m ² K/W	6.0 m ² K/W
R_c ground floor	3.0 m ² K/W	3.0 m ² K/W	3.5 m ² K/W	3.5 m ² K/W	3.5 m ² K/W
U-value window	1.8 W/m ² K	1.8 W/m ² K	1.65 W/m ² K	1.3 W/m ² K	1.3 W/m ² K
heating	high-efficiency gas-fired boiler with radiators (high-temperature heating)	high-efficiency gas-fired boiler with radiators (high-temperature heating)	high-efficiency gas-fired boiler with radiators (low-temperature heating)	high-efficiency gas-fired boiler with radiators (low-temperature heating)	high-efficiency gas-fired boiler with radiators (low-temperature heating)
ventilation	self-regulating vents for supply and mechanical exhaust	balanced ventilation with heat recovery	balanced ventilation with heat recovery	self-regulating vents for supply and demand controlled mechanical exhaust	demand controlled balanced ventilation with heat recovery
solar thermal collector	2.8 m ²	-	2.3 m ²	-	-
pv system	-	-	-	6.4 m ²	6.4 m ²
EPC	0.78	0.74	0.53	0.40	0.40

TABLE 3.1 Overview of insulation values and used installations for typical mid-terraced dwellings in the Netherlands in 2006, 2011 and 2015

The actual primary energy demand for the reference dwelling in 2015 is higher than in 2011, but the energy performance certificate (EPC) is lower since the reference dwelling of 2015 has a photovoltaic system installed. The generated electricity is for a part used to lower the electricity used by the building systems, but the other part accounts for a bonus that lowers the EPC.

What [Figure 3.4](#) shows is that in general more stringent requirements on energy performance are primarily battled with new or improved technical systems (e.g. mechanical ventilation with heat recovery, solar thermal collectors and photovoltaic systems). Since installations such as balanced ventilation systems and high-efficiency gas-fired boilers for space heating and domestic hot water have become the standard, climate control systems still rely heavily on fossil fuels and are to a large extent ignorant of their context; its environment and its occupants.

§ 3.2.2 How to tackle the energy demand

The urge to fully control the indoor environment resulted in the adoption of mechanical climate control systems. Such systems operate almost completely separate from the building and its environment. In other words, the same system works 'fine' in any other building anywhere in the world.

How do we meet our energy demands today?

Up until today, most buildings still depend on mechanical systems that run on non-renewable sources of energy. Installations that are either gas-fired or run on electricity that is foremost generated from burning gas or coal; only 4% of total primary energy demand in the Netherlands is covered by renewable sources (2014; <http://statline.cbs.nl>). This all happened in a time that fossil minerals were very cheap because they seemed to be inexhaustible. Energy-efficiency and environmental concern were hardly an issue and therefore no point of consideration.

Fossil minerals are harvested with conventional mining techniques and then transported to a power plant where they are refined or burned to produce secondary energy sources such as heat, electricity or fuel. Power lines or piping then deliver these secondary energy sources to buildings, where they drive the different mechanical installations for heating, cooling and ventilation ([Figure 3.6](#)).

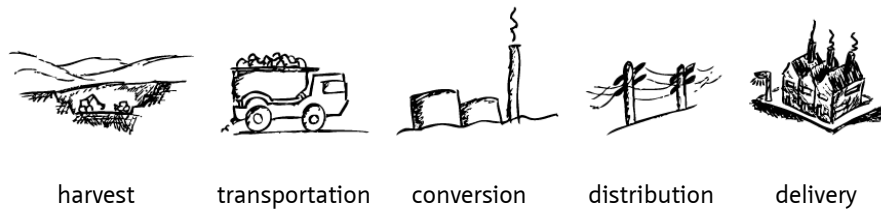

FIGURE 3.6 Meeting energy demand from the remote conversion or refinery of non-renewable sources.

Human activities worldwide put an enormous pressure on the earth's resources. Due to population growth, increased wealth and upcoming new industries, the demand for energy is growing explosively. So far mankind mainly trusts on fossil fuels to fulfil these energy needs. As a consequence, large-scale mining of fossil fuel results in many environmental burdens such as resource depletion, scenery damage, waste production, CO₂ emissions and other forms of pollution.

For some time now the environment is getting more and more attention, making way for sustainable solutions of energy provision. Besides, due to an increasing worldwide demand and a declining stock of fossil minerals, energy prices are becoming very unstable. This makes innovative new techniques suddenly economically interesting and, moreover, viable.

Towards a sustainable energy strategy

The path to sustainable energy housekeeping in buildings is transitional and embraces improving existing techniques, presenting new innovative solutions and thinking in whole new concepts. A three-step approach commonly known as the Trias Energetica has been all the rage in tackling the energy problem since the late 1980s.

The basics of the three stage approach were first mentioned by Duijvestein (1989) and are applicable to a more general strategy of tackling environmental problems. His first stage incorporates the prevention of unnecessary use, followed by the employment of renewable sources and by the intelligent use of finite sources. A three step approach with a specific focus on energy was later named Trias Energetica by Lysen (1996) and has since become the synonym for the three step approach to tackle energy problems. However, this approach has a slightly different focus than the original three steps by Duijvestein. In Lysen's first step the focus is on energy efficiency rather than on prevention. However, energy demand reduction is generally considered as the initial step in the Trias Energetica and energy-efficiency is associated with the (cleaner) use of fossil fuels in the third step. Nowadays, a New Stepped Strategy that eliminates the utilisation of fossil fuels altogether and instead introduces the utilisation of waste flows as a new second step is more commonly adopted (Figure 3.7, Van den Dobbelssteen, 2008).



FIGURE 3.7 The new stepped approach to sustainable energy design. Adapted from Van den Dobbelaer (2008).

This concept can even be stretched from the building to the city scale (Tillie et al., 2009). The first step of the smallest scale (highlighted in grey, Figure 3.8) is considered to be the founding approach for the application of climate-responsive building elements.

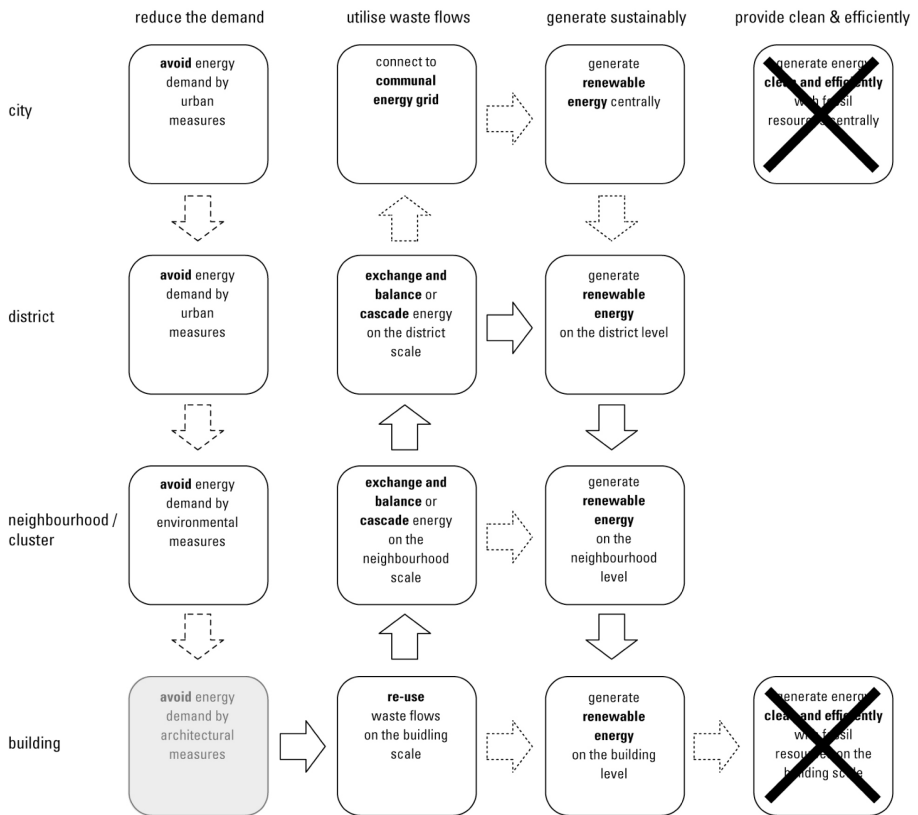

FIGURE 3.8 REAP methodology; a generic method for the sustainable redevelopment of urban areas. Reprinted from Tillie et al. (2009).

A final step in cutting down on the chain from harvest to use can be made by minimising in-building infrastructure for energy transport by directly using the energy flows in the built environment or by integrating the infrastructure in structural and architectural building elements. This draws the general concept behind climate-responsive building design from an energy point of view: the design of buildings that manage natural energy flows in order to provide comfort in close interaction with the dynamic conditions of the built environment. More specific, the ability of structural and architectural elements to play an active role in the harvest of energy, the so-called climate-responsive building elements, is the main focus of this research. Which low graded energy sources within the built environment can be put to use for the creation of healthy and comfortable indoor environments is the topic of the next chapter.

§ 3.3 Boundary conditions of the energy concept of design

With climate-responsive design the relation between comfort and building context is restored. This brings new possibilities to design. However, climate and context generate boundary conditions. These conditions come along conditions set by other design issues, such as spatial, functional and comfort-related design issues. As many of these boundary conditions may already have a major influence on the energy concept of a design, their identification is fundamental to climate-responsive design.

§ 3.3.1 Spatial and functional boundary conditions

The way buildings are organised and used are of great influence on the basic comfort demands (and thus energy needs). For instance, by connecting different housing units together part of the building envelope becomes exposed to environments with similar, more tempered conditions; as opposed to detached dwellings that are completely surrounded by dynamic outdoor conditions. Another approach is to adapt the building plan to follow patterns of use. For example, zones that require daylight and or heating can be positioned towards the sun.

Moreover, occupant behaviour is becoming utterly important in far-reaching strategies of demand reduction; especially in a strategy where comfort is delivered where needed and when needed. Take for example different patterns of use between elderly people and families with children. Elderly spend more time indoors at home and require a smaller bandwidth with elevated temperatures in which the comfort zone may vary.

BOUNDARY CONDITION	DESCRIPTION	DESIGN CONSIDERATIONS
site selection and planning	The energy potential of one site may be better fit for a certain design problem than the other. However, in many design cases the plot is already decided for by the principal. This only leaves site-specific energy potential of the selected site to the architect.	<ul style="list-style-type: none"> - Consideration of site specific features such as plot orientation, situation (urban or rural) and potential of (existing) landform and vegetation.
building density	The total amount of units on a certain plot. With higher densities more units need to benefit from the same energy potential.	<ul style="list-style-type: none"> - Increased densities require more stringent measures on reducing energy demand. - Higher densities allow sharing of design solutions that can boost effectiveness as opposed to when applied on the scale of a single building unit. - Higher densities allow (more) cost-effective application of shared solutions.
organisation and stacking of dwellings	For example, apartment building, terraced dwellings or detached house. The dwelling type determines the ratio between specific areas of the building skin (ground floor, façade, roof) available for energy harvest.	<ul style="list-style-type: none"> - Apartments have a low unit-specific surface exposed to ambient conditions, no specific surface to the soil and large surface adjacent to other apartments. Energy is therefore particularly to be harvested at the façade or through communal systems. - A detached house has large surfaces exposed to ambient conditions, a significant surface exposed to the soil and no surface adjacent to other buildings. This makes that energy can be harvested virtually from any side of the building. However, as a result, the large effective heat loss area requires special attention to limit energy losses.
target group	Human presence and related comfort requirements differ from group to group: families with children, two-income couples with no children, single persons, elderly, etc.	<ul style="list-style-type: none"> - Elderly spend most time indoors and require a smaller band width in which the comfort zone may vary. This would put more emphasis on sustained retention of certain comfort levels. - Two-income families with no children and single persons use the house (and its living spaces) more intermittently, which would benefit more from a decentralized demand-driven comfort control strategy. - Families with children will use the house more continuous, occupying different zones at the same time. This would call for an individual operable demand-driven control strategy.
price range	The price range of the development (e.g. social housing or penthouses) partly set the available budget for comfort-control related investments.	<ul style="list-style-type: none"> - Future occupants of social housing projects are best helped by low operational costs. - Development of more expensive dwellings give an opportunity to apply more expensive solutions.

TABLE 3.2 Spatial and functional boundary conditions and their effect on the energy concept.

This would put more emphasis on energy conservation and buffering techniques. Families with children will occupy different zones at the same time, but less continuous. This would call for an individual operable, demand-driven control strategy.

Already in the design brief, the specification of the design task, many spatial and functional conditions are put down that affect the design's energy concept. Such conditions include site selection and planning, building density and the stacking and organisation of dwellings, and the target group, amongst others. It is fundamental to identify these conditions and their effect on the energy design concept. An overview of such boundary conditions and their effects on the energy concept is given in [Table 3.2](#).

§ 3.3.2 Comfort-related boundary conditions

What we define as comfortable has far-reaching implications for the way we design buildings and how we operate them, and therefore, the energy use for controlling an indoor environment to maintain a certain level of comfort. The identification of comfort-related objectives and constraints (e.g. minimal indoor climate requirements) is essential in a climate-responsive design process. In [Table 3.3](#) an overview is given of relevant comfort-related parameters and the considerations regarding the design of the energy concept.

COMFORT-RELATED PARAMETER	DESCRIPTION	DESIGN CONSIDERATIONS
Thermal comfort requirements and target values (traditional vs. adaptive)	Determines the general heating and cooling strategy.	<ul style="list-style-type: none"> – Tune passive heating strategies to the heating demand, thus optimize for the times most needed, and complement with strategies of conserving or storing energy. – Group zones with similar requirements and position them in the building plan (orientation, floor level) according to the energy offer.
Summer comfort	Strategies to prevent and overcome issues of overheating.	<ul style="list-style-type: none"> – Prevent issues of overheating by keeping heat out or accelerated discharge of gained heat. – Apply passive cooling strategies using lower temperature sources in the surroundings.
Air quality requirements (e.g. maximum CO ₂ concentration)	Ventilation strategy: when and where to ventilate.	<ul style="list-style-type: none"> – Eliminate contamination sources as much as possible. – Employ demand-control ventilation: design for decentralized ventilation with heat recovery in cold periods.
Humidity requirements	Defines humidity-control measures.	<ul style="list-style-type: none"> – Moisture buffering strategies (e.g. hygroscopic interior wall and ceiling finish) is a supplement to typical control strategies based on ventilation. – Buffering techniques enable moisture control spread over time, eliminating the need for direct increased ventilation and possible accompanying issues of discomfort.
Acoustic requirements	Acoustical behaviour of elements and finishes	<ul style="list-style-type: none"> – Unobstructed flow of (ventilation) air throughout the building should match requirements on noise levels.
Illumination requirements	Defines window size and arrangement, glare protection measures and privacy control.	<ul style="list-style-type: none"> – Allowance for sufficient daylight admission in tune with heat transfer (solar access and transmission losses). – Special attention to daylight admission is needed in densely built environments. Highly placed windows can be more effective.
User intervention	Adaptive control measures	<ul style="list-style-type: none"> – Although it sometimes may seem that adaptive control measures are in conflict with a low-energy strategy, this is not per se true since adaptive control measures improve comfort experience and the acceptance of short-term deviations. A valid climate-responsive concept is able to minimise the negative energy effects of user intervention. In addition users can be made aware of the energy and comfort impact of their actions.

TABLE 3.3 Comfort-related boundary conditions and their effect on the energy concept.

§ 3.4 Conclusion

As pointed out in the introduction of this dissertation the employment of non-renewable energy sources redirected building design away from the context of local environment and climate, and so the context lost its function as a boundary condition of design. At least for comfort and energy aspects of design. The vast input of non-renewable energy sources guarantees unconditional control of comfort systems. However, leaving comfort provision entirely to such systems is not necessarily synonymous with the realisation of a comfortable and thus functional environment. As discussed in this chapter it can be, and often is, quite the contrary.

By putting the people in charge of their own environment they are also put in charge of the decisions that affect energy consumption. From the perspective of energy-saving user control can be extended to the concept of demand control. With demand control comfort is delivered when needed and where needed. Although demand control links to a large extent to user control it does not necessarily require the user to be in control, but merely the presence and activity of the user. However the user can still stay (partly) in control and the concept has the potential of reducing energy consumption while comfort is only delivered locally and at desired moments; acting as a supplementing strategy. With climate-responsive design buildings become a manager of natural energy flows in order to provide comfort in close interaction with the dynamic conditions of outdoor climate and the user. This entails an improvement in energy sustainability by the exclusion of non-renewable energy sources but it also draws a line to human preference for diversity and to the way the outdoor environment is used as a source of information.

The climate and context-related boundary conditions are discussed in chapter 4, alongside the quantification of the energy potential of the built environment.

References

- Agentschap NL (2013) Referentiewoningen nieuwbouw 2013. Sittard, The Netherlands: Author.
- Baker, N. (2004) Human Nature in Steemers, K. and Steane, M.A. [eds.] (2004) Environmental Diversity in Architecture. New York: Spon Press.
- Baker, N. and Standeven, M. (1996) Thermal comfort for free-running buildings in Energy and Buildings, vol. 23, issue 3, pp. 175-182.
- Bluyssen, P. M. (2013) The Healthy Indoor Environment: How to assess occupants' wellbeing in buildings. Hoboken: Taylor and Francis.
- Bonnefoy, X. (2007) Inadequate housing and health: an overview in International Journal Environment and Pollution, vol. 30, issue 3/4, pp. 411-429.
- Bordass, B., Bromley, K. and Leaman, A. (1993) User and Occupant Controls in Office Buildings in Proceedings of Building Design, Technology and Occupant Well-being in Temperate Climates 1993, Brussels, Belgium.
- Boyce, P., Hunter, C. and Howlett, O. (2003) The benefits of daylight through windows. New York: Lighting Research Center.
- Brager, G.S. and De Dear, R.J. (1998) Thermal adaptation in the built environment - a literature review in Energy and Buildings, vol. 27, issue 1, pp. 83-96.
- Brager, G.S., Paliaga, G. and De Dear, R. (2004) Operable windows, Personal Control and Occupant Comfort in ASHRAE Transactions 4695, RP-1161.
- De Gids, W.F., Jacobs, P., De Jong, P. and Phaff, J.C. (2012) Een onderzoek naar de effecten en gevolgen van ventilatie. Delft, The Netherlands: TNO.
- Duijvestein, K. (1989) An Ecological Approach to Building in Riedijk, W., Boes, J. and Ravesteijn, W. [eds.] (1989) Appropriate Technology in Industrialized Countries, pp. 235-267. Delft, The Netherlands: Delft University Press.
- European Environment Agency (2013) Environment and human health: Joint EEA-JRC report, No 5/2013. Luxembourg, Luxembourg: Publications Office of the European Union.
- Fanger, P.O. (1970) Thermal comfort - analysis and applications in environmental engineering. Copenhagen, Denmark: Danish Technical Press.
- Hellinga, H.I.J. (2013) Daylight and View - The Influence of Windows on the Visual Quality of Indoor Spaces. Zutphen, The Netherlands: Wöhrmann Print Service.
- Heschong, L. (1979) Thermal Delight in Architecture. Boston: MIT Press.
- ISSO (2004) ISSO publicatie 74: Thermische Behaaglijkheid - Eisen voor de binnentemperatuur in gebouwen. Rotterdam, The Netherlands: ISSO.
- Jongeneel, W.P., van Balen, E.C., Koudijs, E.A., Staatsen, B.A.M. and Houweling, D.A. (2009) Binnenmilieu - recente wetenschappelijke ontwikkelingen en beleid op een rij. Bilthoven, The Netherlands: Rijksinstituut voor Volksgezondheid en Milieu.
- Klimapedia (2015) Energievademecum - energiebewust ontwerpen van nieuwbouwwoningen, herziene versie 2015. Utrecht, The Netherlands: Rijksdienst voor Ondernemend Nederland.
- Kurvers, S.R., Van der Linden, A.C. and Cauberg, J.J.M. (2008) Literatuurstudie thermisch comfort, Werkpakket 1: vraagsturing en binnenmilieu. EOS-project Duurzame projectontwikkeling (EOS-LT), internal publication.
- Leupen, B. and Mooij, H. (2008) Het ontwerpen van woningen - een handboek. Rotterdam, The Netherlands: NAI publishers.
- Lysen, E.H. (1996) The Trias Energica: Solar Energy Strategies for Developing Countries in proceedings of Eurosun Conference 1996, Freiburg, Germany.
- Majcen, D. (2016) Predicting energy consumption and savings in the housing stock - a performance gap analysis in the Netherlands (Doctoral dissertation). Delft, The Netherlands: A+BE | Architecture and the Built Environment. Retrieved from <http://repository.tudelft.nl/islandora/object/uuid%3A00795500-6704-49c0-903f-6b6ba77dc544>
- NEN 15251 (2007) Indoor environmental input parameters for design and assessment of energy performance of buildings addressing indoor air quality, thermal environment, lighting and acoustics. Delft, The Netherlands: Author.
- Nicol, J.F. and Humphreys, M.A. (2002) Adaptive thermal comfort and sustainable thermal standards for buildings in Energy and Buildings, vol. 34-6, pp. 563-572.
- Oseland, N.A. (1995) Predicted and reported thermal sensation in climate chambers, offices and homes in Energy and Buildings, vol. 23, pp. 105-115.
- Parpaire, K. (2004) Daylight perception in Steemers, K. and Steane, M.A. [eds.] (2004) Environmental Diversity in Architecture. New York: Spon Press.

- Peeters, L., De Dear, R., Hensen, J. and D'haeseleer, W. (2009) Thermal comfort in residential buildings: Comfort values and scales for building energy simulation in *Applied Energy*, vol. 86, pp. 772-780.
- Rijksdienst voor Ondernemend Nederland (2015) Referentiewoning EPC 0,4 Tussenwoning. Utrecht, The Netherlands: Author.
- SenterNovem (2006) Referentiewoningen nieuwbouw. Sittard, The Netherlands: Author.
- Shove, E. (2004) Social, architectural and environmental convergence in Steemers, K. and Steane, M.A. [eds.] (2004) *Environmental Diversity in Architecture*. New York: Spon Press.
- Steemers, K. (2009) Sustainable design and well-being in *Proceedings of Sustainable Healthy Buildings 2009*, Seoul, Republic of Korea, pp. 173-179.
- Szokolay, S.V. (2008) *Introduction to Architectural Science - the basis for sustainable design* [second edition]. Oxford, England: Architectural Press.
- Tillie, N., Van den Dobbelsteen, A., Doepel, D., De Jager, W., Joubert, M. and Mayenburg, D. (2009) REAP Rotterdam Energy Approach and Planning – towards CO2 neutral urban development. Rotterdam, The Netherlands: Project group Hart van Zuid, Rotterdam Climate Initiative.
- Van den Dobbelsteen, A.A.J.F. (2008) Towards closed cycles - New strategy steps inspired by the Cradle to Cradle approach in *Proceedings of the 25th Conference on Passive and Low Energy Architecture*, Dublin, Ireland.
- Van der Linden, A.C., Boerstra, A.C., Raue, A.K., Kurvers, S.R. and De Dear, R.J. (2006) Adaptive temperature limits: A new guideline in The Netherlands - a new approach for the assessment of building performance with respect to thermal indoor climate in *Energy and Buildings*, vol. 38, issue 1, pp. 8-17.
- Van Marken Lichtenbelt, W.D., Kingma, B., Van der Lans, A. and Schellen, L. (2014) Cold exposure - an approach to increasing energy expenditure in humans in *Trends in Endocrinology & Metabolism*, vol. 25-4, pp. 165-167.
- Volkshuisvesting, Ruimtelijke Ordening en Milieubeheer (2010) *De luchtkwaliteit om ons heen - Informatie over de kwaliteit van de lucht bij u in de buurt*. Den Haag, The Netherlands: Ministerie van Volkshuisvesting, Ruimtelijke Ordening en Milieubeheer.
- World Health Organization (2014) *Basic Documents - forty-eighth edition*.

4 The energy potential of a built environment

The location of the building site defines the availability of climate resources. The design of the building defines in what way these climate resources affect the building's energy balance. Available climate resources include air and ground temperature, the position of the sun in the sky, sky cover, intensity of solar radiation, wind speed and direction, humidity and the presence of nearby vegetation and water bodies. In this chapter the energy potential of local climate resources in order to meet comfort demands in buildings is researched.

There are many low graded energy sources that can be put to use in the built environment. Here, a primary component is occurring local climate. In order to exploit the potential of local climate one needs to understand its dynamics. Local climate is a derivative of global climate. Therefore, the study of globally occurring natural processes that together shape climate is a good starting point for exploring the energy potential of the built environment. These global phenomena are then narrowed down to the scale of local climate conditions and considered in an urban context since local climate can be significantly distorted by urban tissue and layout, and thus provide a different energy potential. The information is collected within distinct containers for main climate resources sun, earth, wind, water and sky (section 4.2).

The impact of long-term expectations of changing climate on the energy potential is taken into account as well (section 4.3). Since buildings are typically built to last for decades, awareness and consideration of climate change and its expected effect on the energy potential is both valid and necessary.

In the final section 4.4 of this chapter the interaction of the climate resources is considered and how they affect the energy potential, resulting in an enumeration of climate-related boundary conditions of the energy concept design of buildings.

§ 4.1 Introduction

Climate is the prevailing state of the earth's atmosphere in a region. The earth's atmosphere is the boundary layer between the earth's body of mass and the galaxy. It consists of a mixture of gases that is attracted to the earth by its gravitational forces. The presence of the atmosphere is one of the exigencies of life on earth. The gas mixture primarily consists of nitrogen (N_2 , 78%), oxygen (O_2 , 21%) and argon (Ar, 0.5%). It also contains so called greenhouse gases such as water vapour (H_2O), carbon dioxide (CO_2), methane (CH_4), nitrous oxide (N_2O) and ozone (O_3) and smaller amounts of other tracer gases and industrial pollution. The atmosphere is divided into several layers. The lowermost layer that is closest to the surface of the earth is called the troposphere. It contains almost three quarters of total atmospheric mass and almost all of its water vapour.

Climate is the result of several dynamic processes that occur continuously and interfere heavily with each other, including tides, evaporation, precipitation, wind, waves, ocean currents, solar radiation, geothermal processes and the production of biomass (e.g. organic material such as plants and trees). All these natural processes are due to three physical phenomena that are considered to be never-ending on the human scale: gravity, nuclear fusion of the sun and radioactive decay within the earth. Climate varies from place to place, while the dynamic processes within the atmosphere interact strongly with the surface of the earth, among others things.

Weather is the current state of the atmosphere and is described with different parameters such as temperature, sun shine, rainfall, cloudiness and humidity. Weather services around the world collect weather data continuously and bring past results together in long-term data sets that reveal a general picture of (local) climate.

Climate is subject to both the state of atmosphere and the earth's subsurface. While the built environment is situated at their boundary layer, the earth's surface, it is strongly affected by their interaction. Mutually, the presence of urban tissue and other elements such as pools and vegetation affect their immediate environment, creating a so-called (urban) microclimate which can be significantly different from the local climate as it would be without the presence of those elements. This is often overlooked in design. Buildings are often considered to be in an open field without any interfering elements; even when bioclimatic design principles are taken into consideration. This chapter quantifies the natural energy offer of the urban microclimate and thus reveals the true natural energy potential of a built environment.

§ 4.2 Climate resources

In this section different climate parameters are analysed. Starting with global climate phenomena and followed by a more specific local climate for the Dutch context, which can be classified as temperate. Climate parameters are quantified where possible. Maps and graphs for global radiation, sunshine hours, ambient temperatures, wind speed and direction and precipitation and evaporation as used in the following sections are long-term derivations for the period 1981 to 2010 (Sluijter, 2011). This data is complemented by measured data of the European Solar Radiation Atlas (<http://www.helioclim.org/esra/>) and the Photovoltaic Geographical Information System (<http://re.jrc.ec.europa.eu/pvgis/apps3/pvest.php>). The climate parameters are presented using distinct containers: sun and sky, earth, wind, and water.¹¹ While the considered climatic parameters are often the result of a combined action of occurring phenomena, this breakdown is done for ease of reading.

Each of these sections concludes with a sub section where the energy potential of the built environment is further discussed to the level of the interface between the building envelope and the environment, including some common ways on how to harvest that energy. The effect of climate change on the energy offer and the impact on a climate-responsive design strategy is discussed in section 4.3.

§ 4.2.1 Sun and sky

The sun acts as a massive atomic stove and fuels all living organisms. From its outer layers it disperses great amounts of electromagnetic radiation in a wide spectrum into the universe. The incident solar radiation that hits the earth's atmosphere at its outer layer is fairly constant at 1362 W/m^2 . This quantity of solar energy is called the solar constant. The amount of solar radiation that actually strikes the earth's surface is called global radiation and can be broken down into a direct and diffuse component. The part that strikes the earth without any hindrance is called direct radiation. That part of global radiation that strikes the earth's surface indirectly after it has been scattered within the atmosphere, due to clouds, water or dust, is called diffuse radiation. A more elaborate representation of the energy balance of the earth's atmosphere under the influence of solar radiation is shown in [Figure 4.1](#).

11 Another useful source of energy is the recovery of energy from waste flows. Although seen as an essential part of energy-efficient design - and thus climate-responsive design - recovery from waste flows is not considered a climate resource and is therefore not part of the elaboration in this chapter.

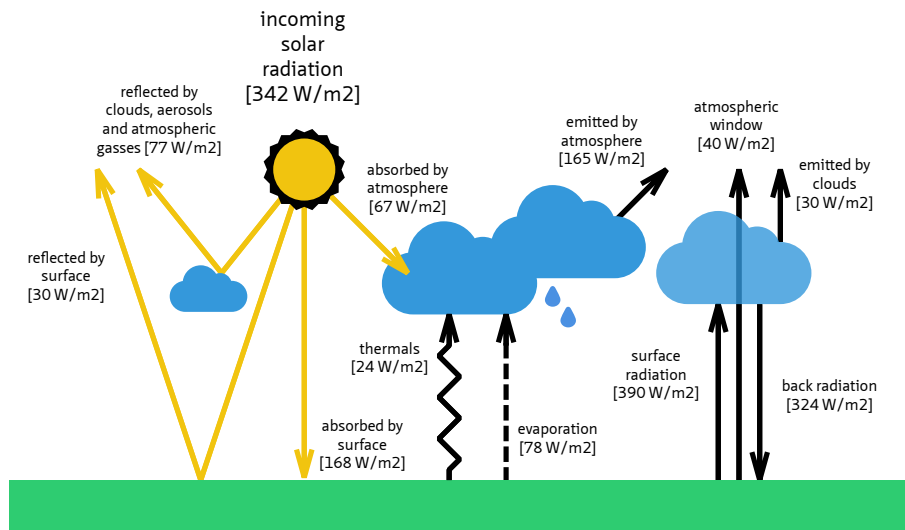

FIGURE 4.1 Energy balance of the earth's atmosphere under the influence of solar radiation. The incoming solar radiation (342 W/m^2) is approximately one-fourth of the solar constant (1362 W/m^2), corrected for the angle of the incoming sun's rays and the fact that half of the earth does not receive any solar radiation at any time. After Kiehl & Trenberth (1997).

The magnitude of global radiation varies with the location on earth and depends on the position of the sun in the sky. The higher the position of the sun, the shorter the distance radiation has to travel from the sun to the earth's surface, and the less reflection. Therefore, a more intense beam of radiation will strike a much smaller area of the earth's surface, both causing increased intensity of global radiation per unit of area. This implies that maximum levels of global radiation will be experienced near the equator. When moving away from the equator, the travel distance to a specific location on earth varies during the year due to the earth's orbit around the sun and its axial tilt. This is what causes seasonal variations in our climate.

Both direct and diffuse radiation is a valuable source of energy. Diffuse radiation makes us experience ambient daylight and, if not reflected back into the atmosphere, global radiation is absorbed in matter as thermal energy.

Energy distribution of sunlight

The sun radiates its beams at various wavelengths. The part of the sun rays that makes us able to see, the visible rays of light, has wavelengths between 380 nm and 780 nm. Next to visible rays, the spectrum contains ultraviolet rays with shorter wavelengths and infrared rays with longer wavelengths. Despite the relative narrow bandwidth, visible light covers almost half of total energy distribution of sunlight.¹²

Global radiation

The amount of solar radiation that travels through the atmosphere and strikes the earth's surface is called global radiation. The average annual amount of global radiation in the Netherlands is 354 kJ/cm² or 983 kWh/m² with slightly higher values at the coastal areas in the western part of the Netherlands. On average the coastal area receives more global radiation than the hinterland, though in winter the spread is more evenly over the country (Figure 4.2).

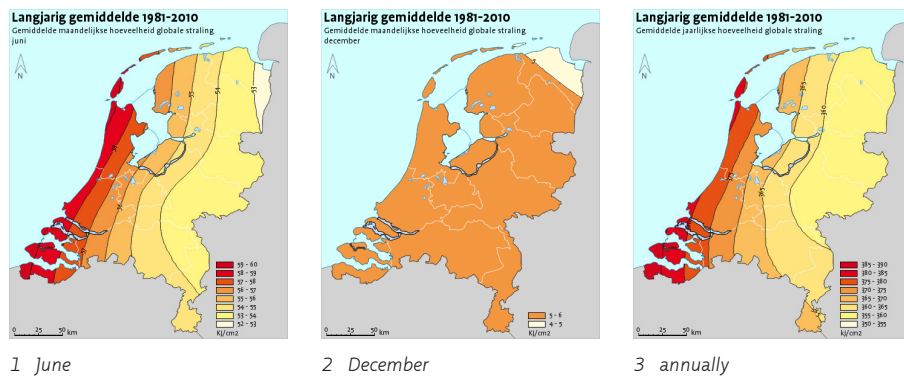

FIGURE 4.2 Average global radiation in the Netherlands. Reprinted from Sluijter (2011).

For the area of Rotterdam monthly average global radiation values reach 155 kWh/m² in the months May, June and July and drop to 23 kWh/m² or below in November, December and January (Figure 4.3).

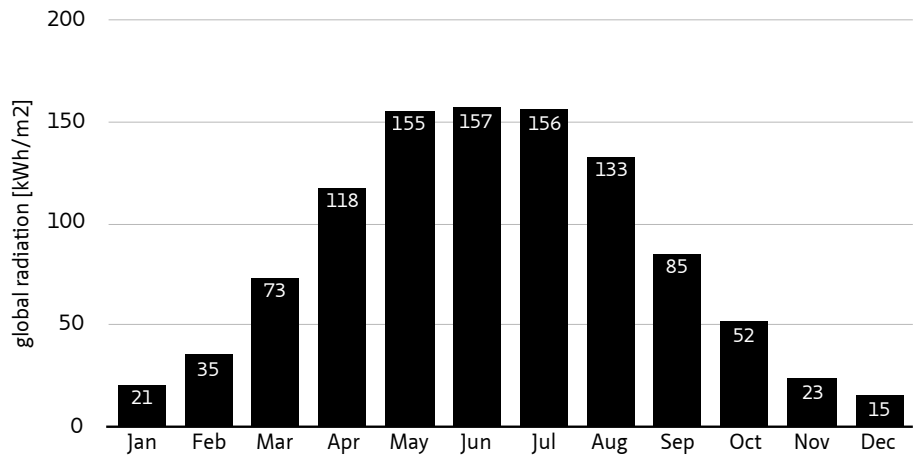

FIGURE 4.3 Monthly average global radiation levels in Rotterdam, The Netherlands. Values retrieved from Sluijter (2011).

As mentioned earlier global solar radiation can be broken down into two components: direct radiation and diffuse radiation. The distribution between direct and diffuse radiation differs from place to place and is strongly affected by the presence of clouds or water in the atmosphere. So, during the cloudiest times of the year most of the global radiation will be diffuse radiation. For the Rotterdam area, the average monthly share of diffuse radiation is at its lowest in April and May, just below 50%. In November and December diffuse radiation share is the highest at 70% (Figure 4.4).

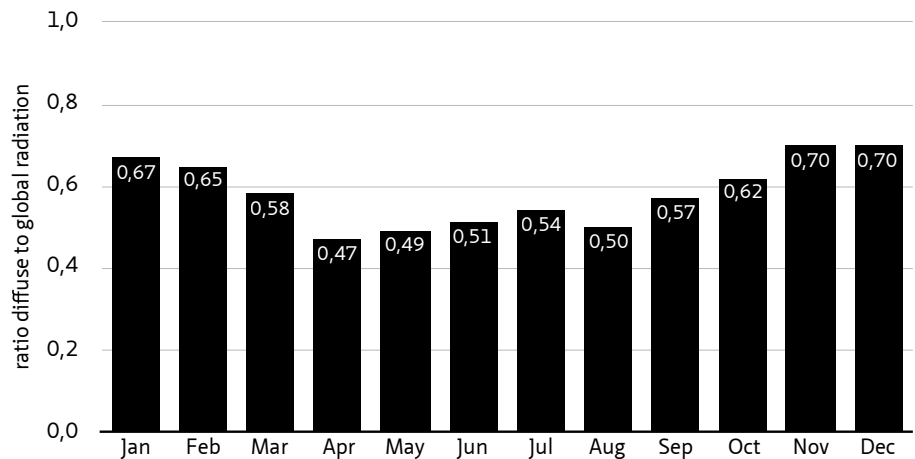

FIGURE 4.4 Ratio diffuse to global radiation in Rotterdam, The Netherlands. Values retrieved from European Solar Radiation Atlas (<http://www.helioclim.org/esra/>) and Photovoltaic Geographical Information System (<http://re.jrc.ec.europa.eu/pvgis/apps3/pvest.php>).

Solar geometry

From an observer's point of view the sun's position can be described by two angles: azimuth and altitude (Figure 4.5). The azimuth is the angle of the horizontal rotation relative to the north, while moving clockwise. The altitude is the angle of the vertical rotation relative to the ground plain. For every location on earth the sun's position throughout the year is calculable and depends on the latitude of your position (i.e. your position north or south of the equator). One can calculate the extreme altitudes of the sun from the following equation: $90^\circ - |(\text{latitude})| \pm 23.5^\circ$.

Take for example the average Dutch person who lives on 52.5° N. The sun reaches its highest position in the sky at the start of summer (summer solstice; around June 21st) of $90^\circ - 52.5^\circ + 23.5^\circ = 61^\circ$. Likewise the sun reaches its lowest position in the sky at the start of the winter (winter solstice; around December 21st) of $90^\circ - 52.5^\circ - 23.5^\circ = 14^\circ$.

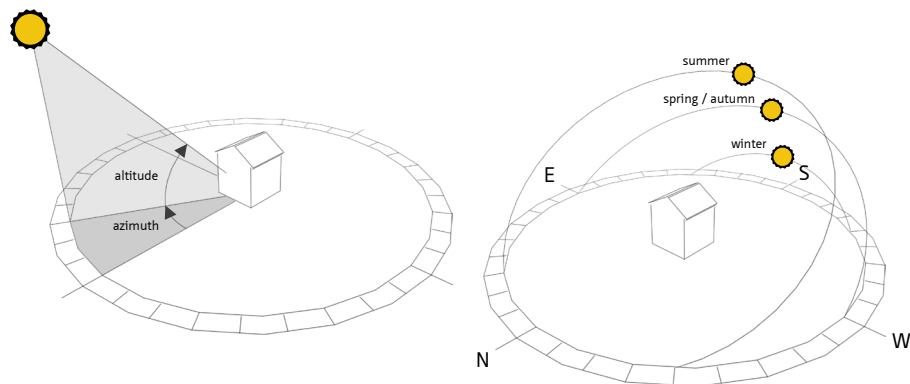

FIGURE 4.5 Solar geometry as function of azimuth and altitude (left) and key-date path of the sun in the sky at 52.5° N (right).

In a sun-path diagram the sun's trajectory is projected onto a horizontal plane, showing the sun's azimuth and altitude at any time of year valid for a specific latitude (Figure 4.6). The dark radial lines from the centre represent the sun's azimuth and the dark concentric lines the sun's altitude. The red lines represent the path of the sun on the 21st day of each month. The red dashed lines represent the hour of the day, in solar time.

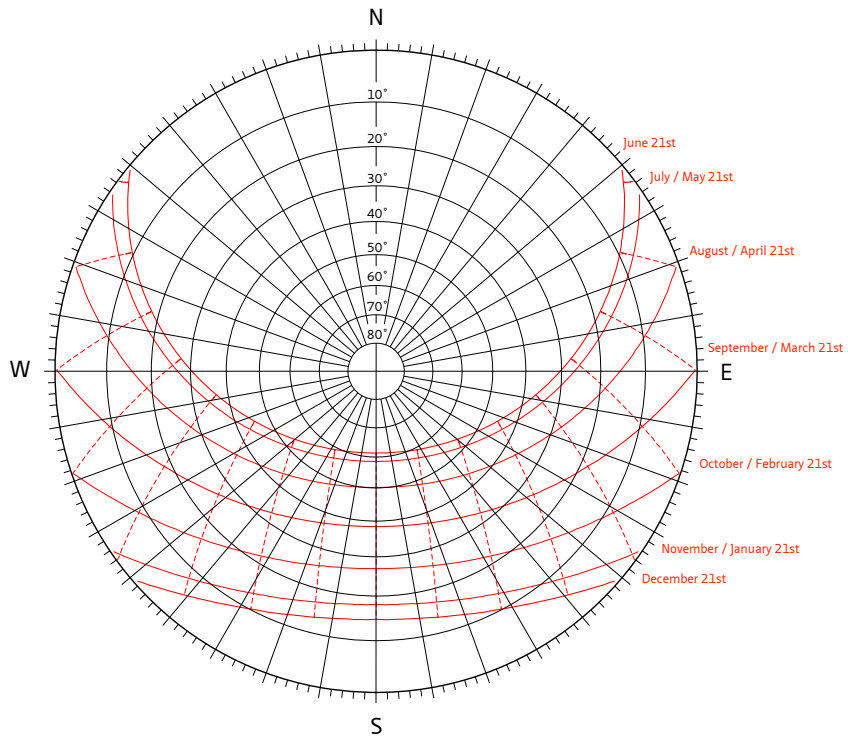

FIGURE 4.6 Sun-path diagram valid for 52° N. The red lines are shown in solar time.

Solar time vs. local time

By definition the sun reaches its highest position in the day due south (in the Northern Hemisphere) at noon, 12:00 hours mean solar time. Both sunrise and sunset then occur at identical angles from noon. For practical reasons we live by local time, which is a standard time valid in a certain region on earth. These regions, or time zones, are typically determined by their longitude and are referenced by Coordinated Universal Time (UTC).¹³ Most European countries, including the Netherlands, use Central European Time (CET) that is one hour ahead of UTC in winter and two hours ahead of UTC in summer.¹⁴

13 Coordinated Universal Time (UTC) is based on international atomic time and is more or less equal to Greenwich Mean Time (GMT), the standard time of longitude 0°. The noon sun, the moment when the sun reaches its highest position due south, is referred to as 12:00 GMT or UTC. *Mean* is added while the noon sun will not occur when exactly crossing longitude 0° throughout the whole year. This is the result of the earth's axial tilt and its variable speed of movement due to the elliptic course around the sun. This difference is known as the equation of time and the difference between mean solar time and apparent solar time may be up to 16 minutes.

14 Many countries, especially in the Northern hemisphere, use Daylight Savings Time (DST) and advance local time with one hour during summer in order to obtain more daylight in the afternoon. Local time is then two hours ahead of UTC. In the European Union summer time typically runs from the end of March till the end of October.

The use of time zones implies that most locations on earth will experience a deviation of local time from solar time. In Amsterdam this deviation is about 42 minutes late, which means that the sun will reach its highest position in the day at about 12:42 hours local time in winter and at 13:42 hours in summer. To illustrate location dependency, with respect to Amsterdam the sun reaches its highest position 8 minutes earlier in the more eastern located city of Groningen. The use of Central European Time stretches from Spain (solar time in Madrid is 75 minutes behind of CET) to Macedonia (solar time in Skopje is 26 minutes ahead of CET) which shows that, besides the fact that local time is based on political and economic factors rather than geographical ones, the use of local time can have a significant effect on the energy potential of the built environment when natural cycles follow solar time and can deviate much from occupancy patterns primarily based on local time.

Sunshine hours

Basically on average 50% of the time daylight is available annually. This would lead to $0.5 * 8760$ hours = 4380 hours of sunshine per year, anywhere on earth. Near the equator this will be evenly spread throughout the day (12 hours of daylight, every day of the year). At the poles it is distributed in bulk (half a year with full days of daylight, half a year with full days of twilight). Between the equator and the poles daylight availability per day is distributed according to its location and the time of the year; typically summertime knows longer days than wintertime.

At the start of spring and at the start of autumn the sun rises from the east and sets to the west exactly 12 hours later. During the summer in the Northern Hemisphere the sunrise shifts to the northeast and sunset to the northwest. In winter time the sunrise shifts to the southeast and sunset to the southwest. The further you travel away from the equator, the longer the days will be in the summer and the shorter the days will be in winter time. At 52° N the longest day of the year (around June 21st) lasts almost 16.5 hours and the shortest day of the year (around December 21st) last for about 7.5 hours.

The sunshine hours are slightly higher in the coastal area. Differences in sunshine hours between various parts of the country are caused by clouds in the sky. Predominate winds from the west and increased convection due to the warming of air above land mass results in more clouds off the coastal area which in turn results in decreased availability of sunshine. In December the spread of available sunshine is more evenly over the country (Figure 4.7). The figures clearly show a lower total amount of available sunshine than 4380 hours. This is because the definition of sunshine in a meteorological sense is different. The World Meteorological Organisation (WMO) defines sunshine when solar irradiance during a certain period is at least 120 W/m², which is roughly enough to cast shadows.

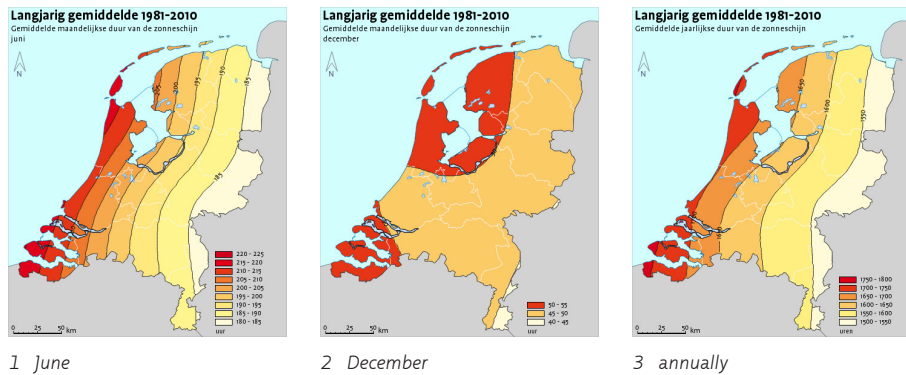

FIGURE 4.7 Average sunshine hours in the Netherlands. Reprinted from Sluijter (2011).

Figure 4.8 shows the monthly average sunshine hours for the Rotterdam area. Values vary from 47 hours in December to 213 and 214 hours in July and May. An important factor in the availability and distribution of natural light is the sky cover, the presence of clouds and dust particles in the sky.

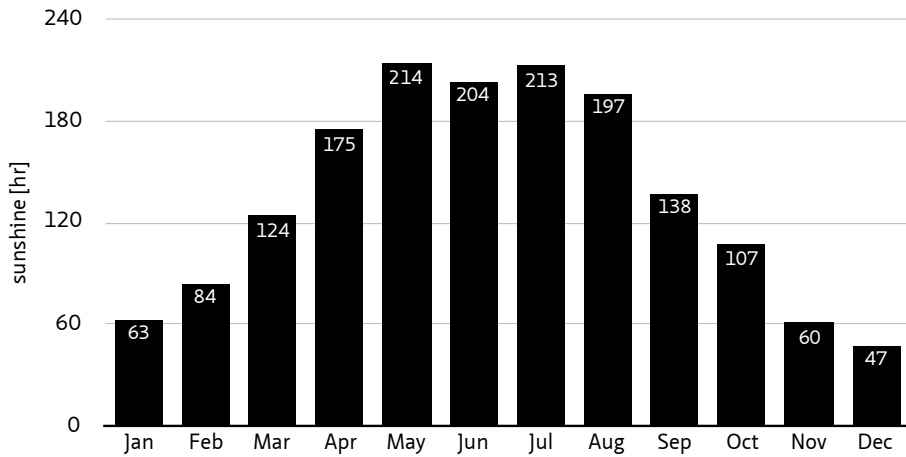

FIGURE 4.8 Monthly average sunshine hours in Rotterdam, The Netherlands. Values retrieved from Sluijter (2011).

Sky cover

For the purpose of daylight design there is a distinction in two extreme sky conditions: clear and overcast. In clear skies there are hardly any clouds obstructing the sun in contrary to an overcast sky where the thickness of the cloud cover makes it impossible to determine the position of the sun and all light becomes diffuse (Figure 4.9).

Light levels vary with time and day of the year and are higher at overcast skies; with the exception of the sun and its corona (i.e. the area directly around the sun) of a clear sky. In general luminance is not distributed evenly throughout the sky. In overcast skies luminance is three times higher at the zenith (the point directly above an observer) than at the horizon (the point perpendicular to the zenith), just opposite of clear skies where luminance is three times higher at the horizon than at the zenith (Figure 4.9).

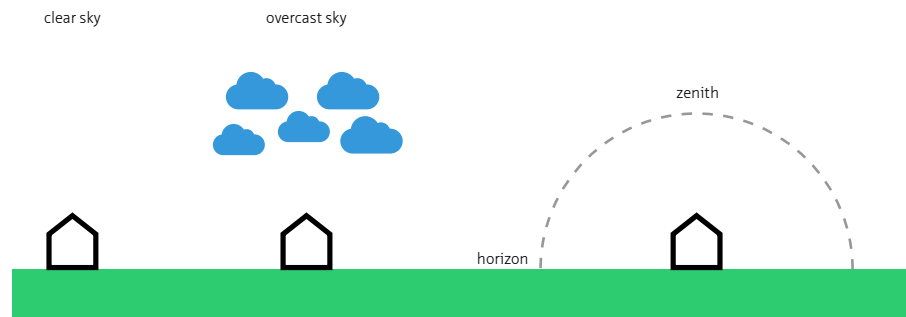

FIGURE 4.9 Difference between clear and overcast sky (left) and explanation of zenith and horizon (right).

Ambient temperature

The temperature of the troposphere, that part of the atmosphere closest to the earth's surface, is for the most (indirectly) heated by the sun's radiation, after being absorbed and re-emitted from earth's surface. Ambient temperatures in the Netherlands are heavily affected by the presence of large bodies of water nearby (i.e. North Sea and the Atlantic Ocean). Air temperatures above water mass don't heat up that quick due to the large heat capacity of water. With prevailing winds from the west (i.e. coming from the water) this relative cool air is blown over the land mass and has a tempered effect.

The average annual temperature in the Netherlands is 10.1°C. The northeastern part of the country is slightly colder than the warmest part of the country, the southwest. In summer the average temperature is 17.0°C, while in winter the average temperature drops to 3.4°C. The highest temperatures in summer occur in the southeastern part of the country (Figure 4.10).

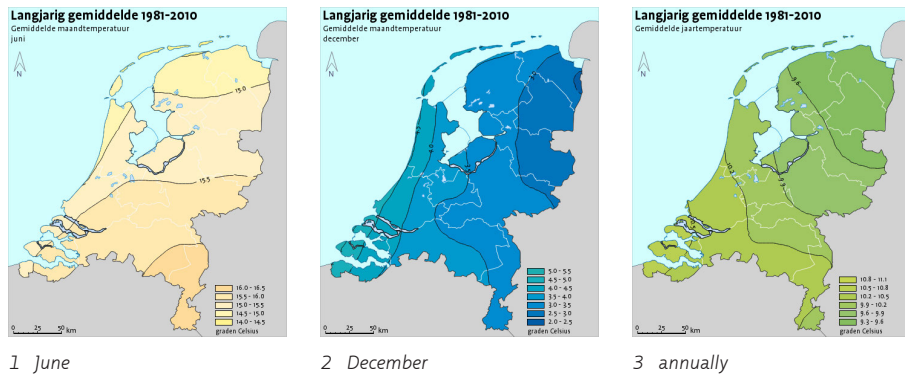

FIGURE 4.10 Average air temperature in the Netherlands. Reprinted from Sluijter (2011).

The average annual temperature in the Rotterdam area is 10.4°C. Temperatures range from 3.6°C in January to 17.8°C in July. Minimum and maximum average temperatures deviate between 2.6°C and 5.1°C from the mean (Figure 4.11).

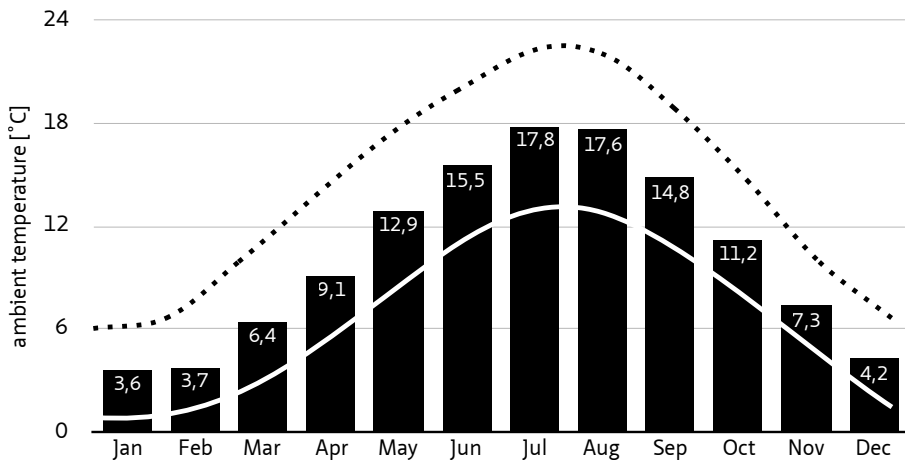

FIGURE 4.11 Monthly average air temperature in Rotterdam, The Netherlands, including minimal and maximum trends. Values retrieved from Sluijter (2011).

Urban heat-island effect

Densely built urban environments strongly affect the local heat balance, causing air temperatures to increase when compared to surrounding country side. This is called the urban heat-island effect. The main causes for this effect are identified as: increased storage of sensible heat in the urban thermal mass, additional heat released from human activities, minimal evaporative cooling effect due to non-vegetated urban surfaces and heat traps due to complex urban geometry.

Depending on sun and wind patterns as the result of urban geometry, the average surface temperature in urban areas can be as much as 2.5°C higher than in rural areas (Buik et al., 2004). The (preliminary) results of a more recent study into the intensity of the urban heat island in the city of Rotterdam (Heusinkveld et al., 2010) shows a maximum difference in air temperature of 7°C when compared to neighbouring rural areas. Measurements were taken on August 6th, 2009 which was a warm day with air temperatures over 30°C. The biggest difference is measured just after sunset. The study also shows the effectiveness of green urban parks on reducing the urban heat island while measurements reveal a temperature rise that is limited to 3°C in the greener urban areas. This increase is the result of several effects including the absorption of solar radiation in street canyons, reduced heat emission due to obstructions (incl. pollution), lower evaporation rates and higher heat capacity due to the presence of less vegetation, and the production of more heat due to human activities (e.g. traffic), among others (Pijpers-Van Esch, 2015).

Energy potential estimation of the sun in a built environment

The average annual amount of global radiation in the Netherlands is approximately 1000 kWh/m² on a horizontal surface (Figure 4.2). The amount of solar radiation on sloped surfaces depends on its orientation (Figure 4.12).

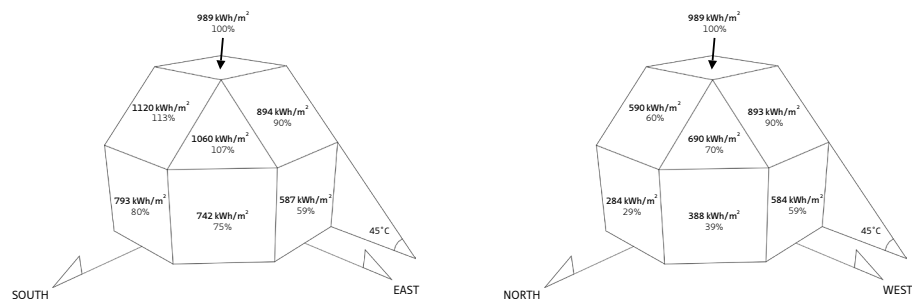

FIGURE 4.12 Annual solar yields for different building surfaces for location Amsterdam, the Netherlands. The given percentages are relative to the amount of solar radiation on a horizontal surface. Values retrieved from Photovoltaic Geographical Information System (<http://re.jrc.ec.europa.eu/pvgis/apps3/pvest.php>).

Maximum annual solar yields of 1130 kWh/m² occur at a surface facing south with a slope of 36° with the horizontal. This is why solar systems are mostly placed according to this orientation and inclination. However, solar yields are not consistent but depend on the time of the year and time of the day. Table 4.1 shows the optimal angle to harvest solar radiation when facing the sun (south in the Northern hemisphere) and the monthly solar yields calculated for the optimal angle on a yearly basis (36°) and for the optimal angle for each month. A slope of 65° on average will increase solar yields with 8.7 to 12.1% during the colder period from November to February when compared to the annual optimal angle of 36°.

	Q_{HOR} (KWH/M ²)	OPTIMAL SLOPE (°)	Q_{36} (KWH/M ²)	Q_{OPT} (KWH/M ²)	YIELD Q_{OPT} OVER Q_{36}
Jan	18	66	30	33	11.1%
Feb	38	62	60	66	8.7%
Mar	69	47	87	88	1.2%
Apr	113	34	128	128	0.0%
May	152	21	155	158	2.1%
Jun	147	14	143	149	4.5%
Jul	153	18	152	157	3.2%
Aug	129	29	140	141	0.5%
Sep	83	43	102	103	0.6%
Oct	49	56	70	74	4.7%
Nov	24	65	39	43	10.8%
Dec	14	67	23	26	12.1%
Year	989	36	1130	1166	3.2%

TABLE 4.1 Monthly solar yields for surfaces facing south with different slopes (Q_{hor} : horizontal surface; Q_{36} : surface with slope of 36° with horizontal; Q_{opt} : surface with optimal slope relevant to the month) for Amsterdam, the Netherlands.

Figure 4.13 and Figure 4.14 show solar radiation levels on the horizontal plane and on vertical planes for different orientations on a typical day in December and June. In December the vertical plane facing south will catch most solar radiation. This would call for solar gain systems that harvest solar radiation facing south. However, in June solar intensity is higher at east and west facing façades and high levels of solar radiation are offered in the beginning or at the end of the day, respectively.

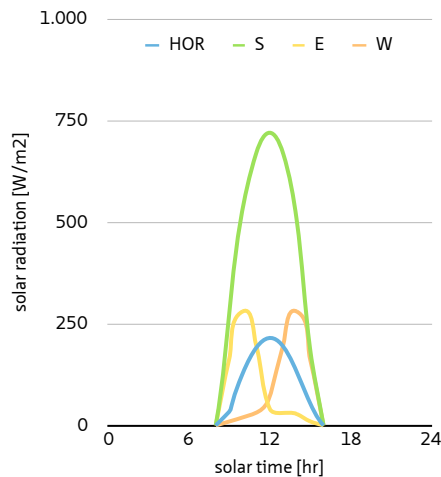

FIGURE 4.13 Solar radiation on a vertical plane for different orientations on a typical day in December for Amsterdam, the Netherlands. Values retrieved from Photovoltaic Geographical Information System (<http://re.jrc.ec.europa.eu/pvgis/apps3/pvest.php>).

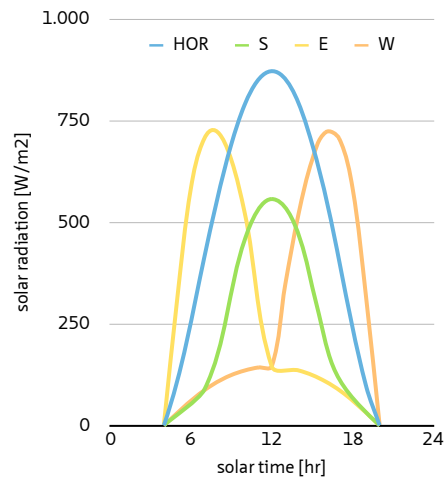

FIGURE 4.14 Solar radiation on a vertical plane for different orientations on a typical day in June for Amsterdam, the Netherlands. Values retrieved from Photovoltaic Geographical Information System (<http://re.jrc.ec.europa.eu/pvgis/apps3/pvest.php>).

Understanding these dynamic patterns may favour solar gain system setups that produce energy closer to actual user needs when they occur rather than maximising solar yields on an annual basis.

One must be aware of the fact that the mentioned figures and numbers apply for a situation where the building is in an open field without any type of obstacle being considered. In a realistic setting, buildings are subject to shadow casting from different elements in their neighbourhood, such as vegetation and other buildings. In a joint effort, this aspect has been researched as part of an extensive study into the influence of some urban and building design parameters (street width and orientation, and roof shape and envelope design) on the solar exposure of the urban canyon and the feasibility of passive solar heating strategies in dwellings (Van Esch et al., 2012). Figure 4.15 shows the total amount of solar radiation (in kWh) on the given days (December 21st and March 21st) for a single urban setting (15 m wide east-west running street) under the influence of different roof shapes. In December no more than 6.5% of the solar radiation that strikes the building is received by the south-facing envelope of the ground floor. The roof has a significantly higher solar exposure in any of the considered setups. The roof should therefore be an important aspect in passive solar design.

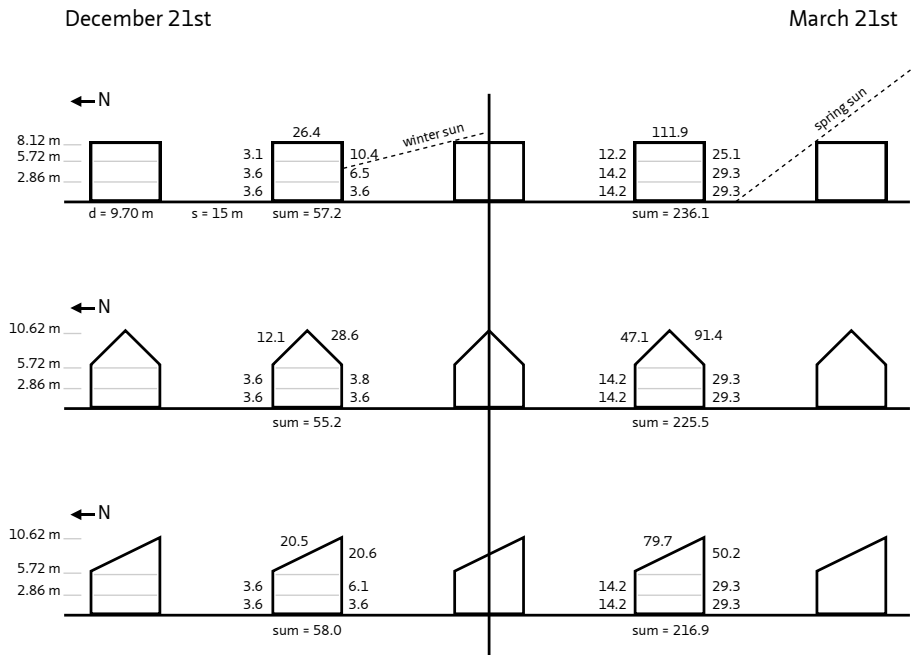

FIGURE 4.15 Solar exposure (in kWh/day) of the envelope under the influence of different roof shapes in an urban setup with a 15 m wide east–west running street. Values are given per distinct part of the envelope (e.g. roof and façade by floor and orientation). Adapted from Van Esch et al. (2012).

§ 4.2.2 Earth

The on-going process of radioactive decay from the earth's inner core produces an on-going flux of heat to its surface, while the temperature of the space surrounding the earth's matter is graded much lower. The temperature drops steadily when reaching the earth's surface, but the gradient depends in both space and time due to several factors, such as soil condition, groundwater flows and surface temperature.

Ground temperature distribution

In the Netherlands, approximately 0.08 W/m^2 of heat released from the inner core of the earth reaches the surface (Davies & Davies, 2010). This is a fraction of the amount of solar energy that strikes the surface. The geothermal gradient in the Netherlands is about 3°C for every 100 meter (TNO-NITG, 2016). This results in an average ground temperature of 70°C at a depth of 2000 m, but can reach up to 95°C locally depending on soil conditions (Figure 4.16).

The temperature of the soil at a shallow depth of 10 m remains relatively stable and corresponds to the average annual surface temperature, which relates to the air temperature swing and dampening effect of soil cover on incoming solar radiation. Closer to the surface the temperature is influenced mainly by seasonal fluctuations (Figure 4.17).

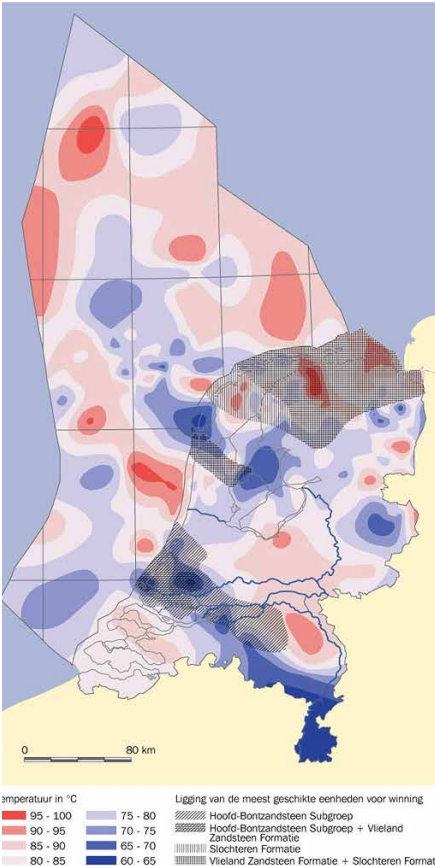

FIGURE 4.16 Ground temperature variation of the soil in the Netherlands at a depth of 2000 m. In order to extract heat from such depths, the presence of permeable aquifers is needed. The hatched areas present the most suitable areas. Reprinted from TNO-NITG.

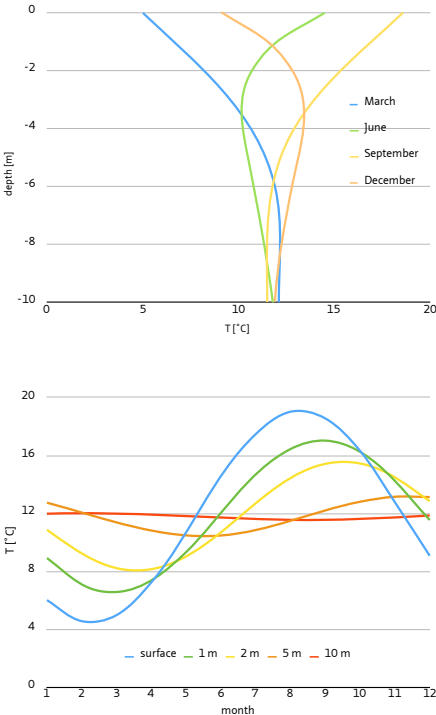

FIGURE 4.17 Ground temperature distribution and variation in shallow layers of undisturbed homogeneous material. The annual variation of soil temperature at different depths can be estimated using a simple trigonometric function (Wu & Nofziger, 1999). Values based on long-term derivations of ambient temperatures swings in The Netherlands (Sluijter, 2011). This distribution is valid for heavy, saturated soil ($\lambda = 2.42 \text{ W/mK}$; $\rho = 3200 \text{ kg/m}^3$; $c_p = 840 \text{ J/kgK}$).

Groundwater flows can disturb the thermal balance of the soil while energy stored in the layers is exchanged with that of remote layers. This behaviour can either be adverse or beneficial, depending on the followed strategy. Groundwater flows can replenish or diminish the stored amount of heat.

Energy potential estimation in a built environment

The temperature of the soil at a certain depth and its variation throughout the year gives a first indication of soil potential for meeting heating and cooling demands. The tempering behaviour of the shallow layers of the ground can be made beneficial in several ways. For example through buried ducts that precondition incoming fresh air.

At greater depths soil temperatures become independent to the air temperature variation above the ground and will rise at greater depths due to the geothermal gradient; the heat radiated from the core of the earth to the surface. The energy stored at depths below 20 m can be retrieved by aid of vertical ground-coupled heat exchangers; a tube-system placed in boreholes in which a medium runs up and down the tubes to extract heat from the ground.

Typical for utility buildings that have a high cooling demand in summer, but also applicable to residential developments, these systems are often extended with a second ground source to create a seasonal storage system. Relative cool temperatures can be subtracted from the ground to cool down the building in summer periods. The heat of the warm return flow is then stored in the second ground source that can be employed for heating purposes in the winter. Beside that the ground can suffice both heating and cooling demands of a building, the dual systems also extends the energy potential of the ground source while it (partially) regenerates the energy stored in the ground.

When travelling further to the centre of the earth, ground temperatures reach up to 70°C at depths of 2000 m (Figure 4.16). These temperatures can be made beneficial to low-temperature space heating or domestic hot water. Due to high costs of realization, such installations are only economically viable at large-scale projects.

§ 4.2.3 Wind

Wind, the movement of air in the atmosphere, is dominated by three phenomena: differences in air pressure, the earth's rotation and friction with the earth's surface. Air movement behaviour is subject to the laws of physics, due to inertia air flow has a tendency to continue its path even when it meets an obstacle. Air always flows from high pressure to low pressure, where air pressure differences occur due to differences in air temperature. Wind velocity is linear to the magnitude of air pressure differences and wind direction depends mostly on the position of areas of high-pressure air and low-pressure air. Due to friction near the surface of the earth, air speeds drop at lower altitudes.

There is a clear pattern in daily and seasonal variation in wind in the Netherlands. Solar radiation warms the air during the day and causes higher wind speeds during the latter part of the day. During autumn and winter low-pressure air lingers near to the Netherlands and has relative large pressure differences with high-pressure air surrounding it, which results in more winds. Wind speed and course near the ground is very whimsical due to turbulence of air which is caused by thermal instability of air temperature and the surface roughness.

Figure 4.18 shows the average annual wind speed in the Netherlands. The highest wind speeds occur near the coast and around the IJsselmeer, where the wind is not slowed down by buildings or vegetation. Throughout the country wind speeds are higher in December than in June.

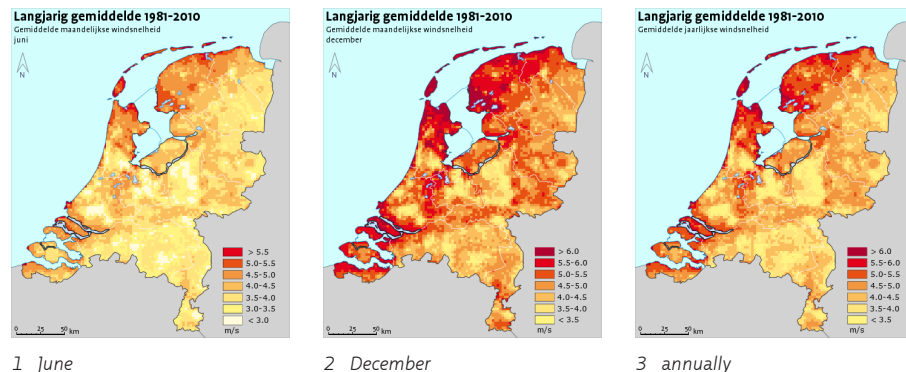

FIGURE 4.18 Average wind speeds in the Netherlands. Reprinted from Sluijter (2011).

Information on wind direction and frequency for a specific location can be visually combined in a wind rose. [Figure 4.19](#) shows the wind rose for Rotterdam, the Netherlands, during the period 1981 to 2010. It reveals an omnidirectional wind with a prevailing wind coming from the southwest. Similar studies for other locations within the Netherlands show nationwide identical results, although with stronger winds near the coast.

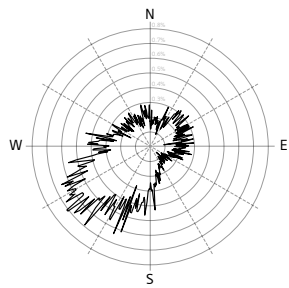

FIGURE 4.19 Wind rose showing wind direction and frequency combined for Rotterdam, the Netherlands. Values retrieved from Sluijter (2011).

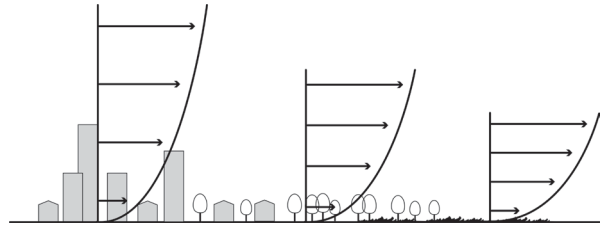

FIGURE 4.20 Visual representation of wind velocity as function of height in open field and a disturbed velocity pattern as function of the height in urban areas. The roughness of urban areas cause the average wind speed to drop and result in more abrupt changes in wind speed and disturbed flow patterns. Reprinted from Pijpers-van Esch, 2015.

Urban wind patterns

Measurements on wind direction and speed is standardised performed in an open field at elevated heights of 10 m. Despite the fact that average wind speeds drop closer to the ground, in dense urban areas air movement is heavily affected by the urban geometry resulting in an even lower average wind speeds, more abrupt changes in wind speeds and disturbed flow patterns ([Figure 4.20](#)). This means that results from the nearest measurement location can't be simply translated one-on-one to the building site.

For moderate to strong winds the average wind speed drops with 20 to 30% when compared to wind in open field. At the same time the intensity of the turbulence of wind increases with 50 to 100%. Furthermore, the mass of the city as a whole creates an urban boundary layer that lies as a canopy over the city. This will introduce vertical air flows in cities that can reach wind speeds of 1 m/s (Allard, 1998; Mertens, 2006).

Energy potential estimation in a built environment

Air movement in built environments can be made beneficial in two ways. The movement of air can be used directly to ventilate or cool down a building. Alternatively, energy can be harvested from wind flows with aid of wind turbines.

Natural ventilation potential

Natural air flow is induced due to differences in pressure. The driving forces of these pressure differences may either be differences in air temperature or wind flow around a building. Both concepts can be made beneficial to naturally ventilate buildings. Temperature-driven ventilation or (passive) stack ventilation is based on difference between density of warm and cool air. Warm air has a lower density which makes it lighter than cool air. Therefore it has a tendency to float upwards. When warm indoor air is able to escape from the building through a high placed opening it will force fresh outdoor air to enter the building from a lower placed opening. The stack effect increases at greater temperature differences and at an increased height difference between the lower and upper openings in the building. Wind-driven ventilation is based on occurring pressure differences around the perimeter of a building when it is struck by wind. At the windward side the pressure will be elevated and fresh air is blown into the building through openings and cracks. At the leeward side the pressure will be lowered which causes an outward airflow through suction.

In reality both driving forces will occur simultaneously. Typically, temperature-driven ventilation will be the main driving force for natural ventilation in winter and wind-driven ventilation will be the main driving force for natural ventilation in summer.

Open windows allow for sufficient ventilation already at small temperature differences and low wind speeds. However, the supply of the driving forces for natural ventilation is random and sometimes difficult to control. It requires careful planning in order to be sufficient at all times. Additional techniques can be employed to enlarge the pressure difference between air inlets and outlets in order to increase the airflow, and thus ventilation capacity.

Besides indoor air quality, natural ventilation also addresses to issues of thermal comfort. Problems can occur when the temperature of fresh air deviates too much from comfortable temperatures. In winter cold airflows can cause draught and in summer extreme outdoor temperatures can contribute to indoor heat accumulation. Problems with cold air can be overcome by paying attention to the way fresh air is introduced into the room or through preheating with aid of a solar space, thermal storage wall or ground-coupled ventilation. Heat accumulation problems in summer can be overcome by drawing fresh air in from shaded areas, nearby water bodies or via ground-coupled ventilation. On the other hand ventilation in summer can also satisfy cooling needs by

either flushing warm air with cool air or via the cooling effect of an air flow that passes human skin. In favour of opening windows to naturally ventilate buildings the ability to open windows also addresses to the human preference for diversity and gives a link to the outdoors; both contributing to the psychological experience of comfort.

Cooling potential of outdoor air

Ambient temperatures in the Netherlands are below the upper boundary of thermal comfort most of the time. Therefore ambient air makes a good heat sink to cool down buildings. Despite of that cooling needs often keep pace with high ambient temperatures, ambient air can still be used to flush indoor air at occasional high internal loads or to cool down building mass and prevent too much heat accumulation during the night at persistent hot weather (i.e. night-time cooling). Even during hot days in summer relative cool air can be extracted from nearby water bodies (evaporative cooling effect) or shaded areas in the direct surrounding of the building. These shaded areas can be created by the building itself or neighbouring buildings or from on-site vegetation.

While urban tissue retains absorbed heat during the day, air temperatures in urban areas during the night will be well above the shown trend. Therefore the urban heat island effect will decrease night-time cooling potential of ambient air in urban environments.

§ 4.2.4 Water

Water is an essential component of life on earth. Over 70% of the earth's surface is covered by water. However, most of this water is not suited for living organisms. The relative small quantity that is potable is replenished from a continuous hydrological cycle. Simplified this cycle consists of five main elements: condensation, precipitation, infiltration, run off and evaporation.

Condensation is the formation of clouds when air temperature drops. If the temperature drops below a certain point (i.e. dew temperature) the clouds cannot retain more water and precipitation will come down. This water hits the earth's surface and either infiltrates into the ground or runs off to open bodies of water (e.g. rivers, pools, etc.). The water that infiltrates the soil will run off as groundwater. Both streams of runoff water will eventually lead to the oceans as they are the largest bodies of water. From here water will evaporate under the influence of solar radiation and the water vapour comes back into the atmosphere and forms clouds. Wind flows will spread the clouds across the earth, closing the cycle. Most precipitation in a region falls at the

highest places. Wind is forced to move up against the elevation which causes the air to cool down. The leeward side in such regions will always show a significant reduction in precipitation levels.

Precipitation and evaporation

The average annual precipitation in the Netherlands is 851 mm (Figure 4.21).¹⁵ There is a clear difference between coastal areas and the hinterland when it comes to seasonal and daily behaviour in precipitation. As a rule, most rain will fall when the temperature difference between the body of mass (either land or water) and the air directly above is the greatest. This difference causes instability of the air: upwards flow of air, condensation and the formation of clouds. The greatest temperature differences in the hinterland will occur in spring and during the summer when solar radiation quickly warms up the land. Due to the enormous heat capacity of water the biggest difference in coastal areas only occurs in fall. Following the same principle, in the hinterland most rain will fall in the late afternoon and the early evening, while near the coast most rain will fall early in the morning.

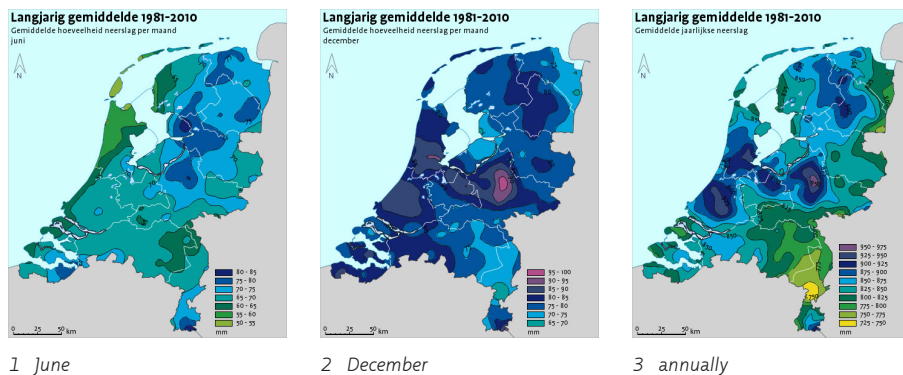

FIGURE 4.21 Average precipitation in the Netherlands. Reprinted from Sluijter (2011).

The evaporation in the Netherlands is not measured, but derived from calculation methods where the availability of sunshine is the primary factor. Therefore evaporation will be higher near the coast due to increased levels of solar radiation (Figure 4.22).

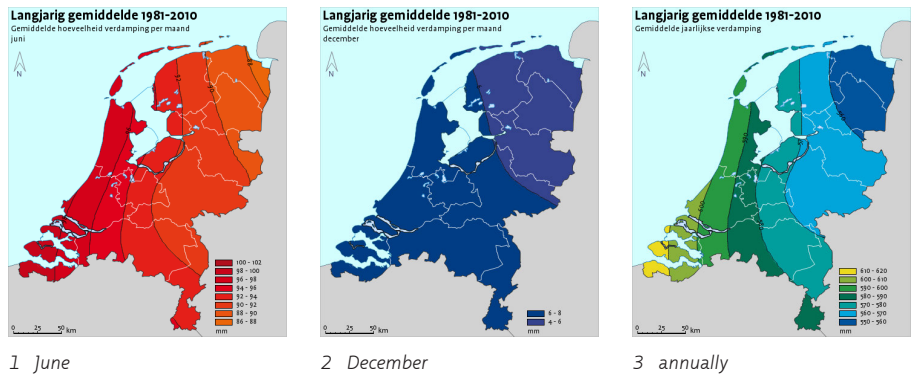

FIGURE 4.22 Average evaporation in the Netherlands. Reprinted from Sluijter (2011).

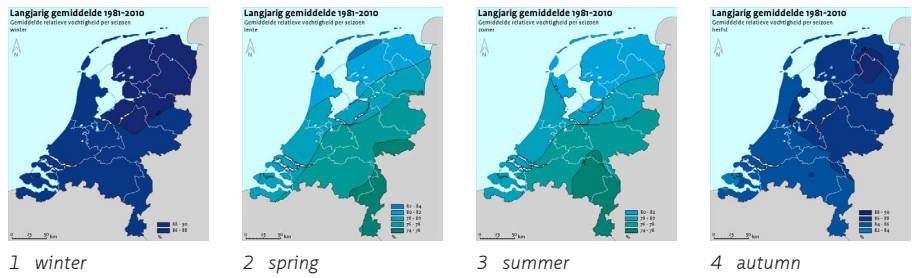

FIGURE 4.23 Average relative humidity in the Netherlands. Reprinted from Sluijter (2011).

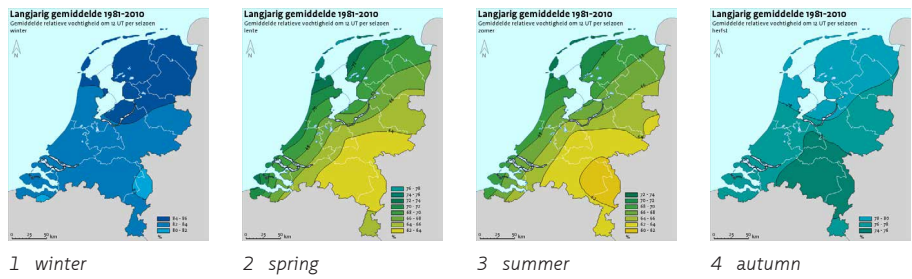

FIGURE 4.24 Average relative humidity at 12:00 hours Universal Time (UT) in the Netherlands. Reprinted from Sluijter (2011).

Air humidity

Air can hold a maximum amount of water vapour depending on its temperature. The higher the temperature, the more water it can contain. Humidity is typically mentioned in relative values, as proportion of water vapour available in the air to what it can contain as a maximum. In general high values of relative humidity occur in the night when the air temperature drops and low values occur during the warmer parts of the day. Relative humidity is on average relatively even throughout the country (Figure 4.23 and Figure 4.24). During summer relative humidity is about 77% and in winter about 88%.

Surface water and groundwater

Surface water has a cooling potential for its direct surroundings. Due to its large thermal capacity the temperature rise of water under influence of solar radiation is much slower than the temperature rise of soil or building mass. The effect of evaporation reduces the air temperature above bodies of water. This cooler air can be employed for cooling purposes (evaporative cooling).

As mentioned earlier, groundwater flows disturb the thermal balance of the soil. This can be undesired when stored heat is carried away along with the flow, but this behaviour can as well be beneficial when stored amounts of heat are replenished.

Water in an urban context

In an urban context the behaviour of the hydrological cycle can be heavily disturbed. Dense urban patterns function as a waterproofing and make infiltration impossible. With the result of sewage overload and soil degradation. Alternatively water retention can be made beneficial in many ways. Local rainwater collection can be used as a grey water source that replaces unnecessary use of potable water (e.g. flushing toilets, watering garden, laundry, etc.). When collected in for example green roofs or open basins the microclimate is affected by evaporative cooling and precipitated dust particles.

Finally green areas assimilated into urban areas allow water to penetrate the ground and cut down on storm water. In addition to the positive effect of green areas on the well-being of humans the arising effect of evapotranspiration (i.e. the combined effect of evaporation of water from the soil and transpiration of water vapour from vegetation) is positive for the thermal microclimate.

High levels of precipitation can also be found near dense urban areas. This can be explained from three factors, the urban heat island effect, the roughness of the urban surface and raised emissions of water vapour from traffic and industry. Concentrated building mass and a rough urban structure cause air to drift upwards easily, amplified with increased water vapour emission this will lead to a higher chance of precipitation.

Energy potential estimation in a built environment

Due to its large thermal capacity the temperature swing of water bodies under influence of solar radiation is tempered when compared to the temperature swing of soil and building mass. Just the presence of surface water will bring about a cooling effect to its direct surroundings. When air flows over surface water the air temperature will drop from the resulting evaporation, because energy is needed for the evaporation of water. The cooling effect can be as much as 2.5°C on hot summer days when the building is next to the water body. The adiabatic cooling effect depends on the distance the air has to travel over the water body and decreases proportionate with the height of the façade (Daniels, 2000).

§ 4.3 The impact of climate change

Since most buildings are meant to last and be used for decades, expected changes in climate are a relevant aspect to consider, especially in climate-responsive design. Climate change reflects changes in the energy offer of climate resources and in possible shifts of comfort demands, and thus in the climate-responsive design strategy to be followed.

The Royal Dutch Meteorological Institute (KNMI) generated different climate scenarios that quantify human-induced climate change for around 2050 and 2085, relative to the reference period 1981-2010 (KNMI, 2014; KNMI, 2015). [Figure 4.25](#) gives an overview of variations for different climate indicators (e.g. temperature, precipitation, wind) considering four different scenarios (all combinations of two possible values for global temperature rise and change in air circulation pattern) and two time horizons (2050 and 2085). The different scenarios are accompanied by natural variations and ‘span the likely changes in the climate of the Netherlands’.

In all four scenarios and both time horizons, overall temperatures will increase which results in more mild winters and hot summers. In 2050 mean temperatures in winter are expected to increase between 1.1°C and 2.7°C, and between 1.0°C and 2.3°C in summer. The number of warm summer days with temperatures over 25°C will increase from 21 days in the reference period to 26 to 36 days in 2050. Together with a slight increase in solar radiation levels the need for cooling, including the prevention of overheating, becomes more important.

However, the potential of both the earth and the nightly ambient air continue to be viable cooling resources. Soil temperatures keep pace with the development of mean ambient temperature, and since the expected increase of mean temperature lies

somewhere between 1.0°C and 2.3°C relative to the reference temperature of 10.1°C, temperatures of the soil at certain depths stay well below the comfort zone. Cooling with nighttime air also keeps profitable during certain times since almost the same unlikeness of periods with temperatures over 20°C during the night in 2050 applies as in the reference period.

With respect to the climate resources of wind and water, the following variations are expected in the climate scenarios. Changes in wind speed during winter are estimated between -2.5% and 0.9% in 2050 and between -2.5% and 2.2% in 2085. Overall precipitation will grow between 2.5% and 5.5% in 2050 and between 5% and 7% in 2085. Winter extremes and summer intensities also grow, although overall summer will become more dry. Both cases are expected to have minimal effect on the climate-responsive design strategy to follow.

In retrospect, mean temperatures rose with 0.9°C and solar radiation levels grew with 2.3% in the reference period 1981-2010 with respect to the prior period of 1951-1980. In that same period precipitation rose with 9.9%

Season ^a	Variable	Indicator	Climate ^a 1951-1980	Climate ^a 1981-2010 reference period	Scenario change values for the climate around 2050 ^b				Scenario change values for the climate around 2085 ^b				Natural variations averaged over 30 years ^a	
					G _L	G _H	W _L	W _H	G _L	G _H	W _L	W _H		
Global temperature rise:					+1 °C	+1 °C	+2 °C	+2 °C	+1.5 °C	+1.5 °C	+3.5 °C	+3.5 °C		
Change in air circulation pattern:					Low value	High value	Low value	High value	Low value	High value	Low value	High value		
Year	Sea level at North Sea coast	absolute level ¹	4 cm below NAP	3 cm above NAP	+15 to +30 cm	+15 to +30 cm	+20 to +40 cm	+20 to +40 cm	+25 to +60 cm	+25 to +60 cm	+45 to +80 cm	+45 to +80 cm	± 1,4 cm	
		rate of change	1.2 mm/year	2.0 mm/year	+1 to +3.5 mm/year	+1 to +5.5 mm/year	+3.5 to +7.5 mm/year	+3.5 to +7.5 mm/year	+1 to +7.5 mm/year	+1 to +7.5 mm/year	+4 to +10.5 mm/year	+4 to +10.5 mm/year	± 1.6 mm/year	
Temperature	mean		9.2 °C	10.1 °C	+1.0 °C	+1.4 °C	+2.0 °C	+2.3 °C	+1.3 °C	+1.7 °C	+3.3 °C	+3.7 °C	+0.16 °C	
	mean amount		774 mm	851 mm	+76 mm	+76 mm	+55 mm	+55 mm	+9 mm	+9 mm	+7 mm	+7 mm	+6.2%	
Precipitation	solar radiation		346 kJ/cm ²	354 kJ/cm ²	+8 mm	+8 mm	+8 mm	+8 mm	+1.2 mm	+1.2 mm	+0.5 mm	+0.5 mm	+1.6%	
	potential evaporation (Makkink)		534 mm ²	559 mm ²	+25 mm ²	+25 mm ²	+25 mm ²	+25 mm ²	+5 mm ²	+5 mm ²	+6 mm ²	+6 mm ²	+1.9%	
Evaporation	potential evaporation (Makkink)		534 mm ²	559 mm ²	+25 mm ²	+25 mm ²	+25 mm ²	+25 mm ²	+5 mm ²	+5 mm ²	+6 mm ²	+6 mm ²	+1.9%	
	number of hours with visibility < 1 km		412 hours	300 hours ²	+110 hours	+110 hours	+110 hours	+110 hours	+120 hours	+120 hours	+120 hours	+120 hours	+19 hours	
Winter	Temperature	mean	2.4 °C	3.6 °C	+1.1 °C	+1.6 °C	+2.1 °C	+2.7 °C	+1.3 °C	+1.8 °C	+2.9 °C	+3.2 °C	+4.1 °C	+0.68 °C
	year-to-year variation ³		-	+2.6 °C	-	-8%	-16%	-13%	-20%	-17%	-15%	-24%	-	
Temperature	daily maximum		5.1 °C	6.1 °C	+1.0 °C	+1.6 °C	+2.0 °C	+2.5 °C	+1.2 °C	+1.7 °C	+3.1 °C	+3.4 °C	+0.46 °C	
	daily minimum		-0.3 °C	0.5 °C	+1.1 °C	+1.7 °C	+2.1 °C	+2.8 °C	+1.4 °C	+1.9 °C	+3.5 °C	+4.4 °C	+0.51 °C	
Temperature	coldest winter day per year		-7.5 °C	-5.9 °C	+2.0 °C	+3.6 °C	+3.0 °C	+5.1 °C	+2.7 °C	+4.1 °C	+5.6 °C	+7.3 °C	+0.91 °C	
	mildest winter day per year		10.3 °C	11.1 °C	+0.8 °C	+0.9 °C	+1.7 °C	+1.7 °C	+1.0 °C	+1.2 °C	+2.8 °C	+3.1 °C	+0.42 °C	
Temperature	number of frost days (min temp < 0°C)		42 days	38 days	-30%	-30%	-50%	-60%	-35%	-50%	-70%	-80%	+3.5%	
	number of ice days (max temp < 0°C)		11 days	2.2 days	-90%	-70%	-70%	-90%	-90%	-90%	-90%	-90%	+3.1%	
Precipitation	mean amount		188 mm	211 mm	+23 mm	+23 mm	+8 mm	+17 mm	+6.5 mm	+12 mm	+13 mm	+30 mm	+8.3%	
	year-to-year variation ³		-	+36 mm	+5%	+9%	+10%	+17%	+6.5%	+12%	+16%	+30%	-	
Precipitation	10-day amount exceeded once in 10 years ⁴		80 mm	89 mm	+9 mm	+10%	+12%	+17%	+6%	+12%	+16%	+29%	+11%	
	number of wet days (> 0.1 mm)		56 days	55 days	-0.3%	+1.4%	-0.6%	+2.4%	-0.3%	+1.0%	-1.3%	+3%	+4.7%	
Wind	number of days > 10 mm		4.1 days	5.3 days	+1.2 days	+1.9%	+20%	+3%	+1.4%	+2%	+3%	+6%	+1.6%	
	mean wind speed		-	6.0 m/s	+1.1%	+0.5%	+2.5%	+0.9%	-2.0%	+0.3%	-2.5%	+2.2%	+3.6%	
Wind	highest daily mean wind speed per year		-	19 m/s	+3%	+1.8%	+3%	0.0%	-2.0%	+0.6%	-1.8%	+2.0%	+3.0%	
	number of days between south and west		44 days	49 days	+5 days	+3%	-1.7%	+5.5%	-1.6%	+6.5%	-6.5%	+4%	+6.4%	
Spring	Temperature	mean	8.3 °C	9.5 °C	+0.9 °C	+1.1 °C	+1.8 °C	+2.1 °C	+1.2 °C	+1.5 °C	+2.8 °C	+3.1 °C	+0.26 °C	
	precipitation	mean amount	148 mm	175 mm	+27 mm	+18%	+17%	+9%	+9%	+15%	+15%	+12%	+10%	
Summer	Temperature	mean	16.1 °C	17.0 °C	+0.9 °C	+1.4 °C	+1.7 °C	+2.3 °C	+1.2 °C	+1.7 °C	+3.2 °C	+3.7 °C	+0.25 °C	
	year-to-year variation ³		-	+1.4 °C	+3.5%	+7.3%	+6%	+9.5%	+9%	+9%	+7.5%	+16%	-	
Temperature	daily maximum		20.7 °C	21.9 °C	+0.9 °C	+1.4 °C	+1.5 °C	+2.1 °C	+1.0 °C	+1.7 °C	+3.0 °C	+3.4 °C	+0.36 °C	
	daily minimum		11.2 °C	11.9 °C	+1.1 °C	+1.3 °C	+1.0 °C	+2.2 °C	+1.4 °C	+1.7 °C	+3.4 °C	+3.7 °C	+0.18 °C	
Temperature	coldest summer day per year		10.3 °C	11.1 °C	+0.9 °C	+1.1 °C	+1.6 °C	+2.0 °C	+1.0 °C	+1.4 °C	+2.7 °C	+3.1 °C	+0.41 °C	
	warmest summer day per year		23.2 °C	26.7 °C	+3.5 °C	+3.9 °C	+3.3 °C	+3.3 °C	+2.0 °C	+2.0 °C	+3.2 °C	+3.9 °C	+0.52 °C	
Precipitation	number of summer days (min temp > 25°C)		13 days	21 days	+8 days	+26%	+30%	+40%	+30%	+30%	+30%	+100%	+133%	
	number of tropical nights (min temp > 20°C)		< 0.1 days	0.1 days	+0.5%	+0.6%	+1.8%	+2.2%	+0.9%	+1.2%	+6.5%	+7.5%	-	
Precipitation	mean amount		224 mm	224 mm	+1.2%	+8%	+1.6%	+1.3%	+1.0%	+8%	+9%	+23%	+9.2%	
	year-to-year variation ³		-	+113 mm	+21 to +5%	+5 to +10%	+1.0 to +1%	+1.0 to +1%	+1.2 to +1%	+2.5 to +1%	-0.5 to +1%	+5 to +10%	+1.5%	
Precipitation	daily amount exceeded once in 10 years ⁴		64 mm	64 mm	+1.7 to +10%	+2.0 to +13%	+5.0 to +21%	+2.5 to +22%	+2.5 to +19%	+2.5 to +19%	+5.5 to +40%	+5 to +40%	+1.5%	
	maximum hourly intensity per year		14.9 mm/hour	15.1 mm/hour	+5.5 to +11%	+7 to +14%	+12 to +23%	+13 to +25%	+8 to +16%	+9 to +19%	+22 to +45%	+22 to +45%	+1.6%	
Precipitation	number of wet days (> 0.1 mm)		49 days	49 days	+0.5%	-5.3%	+0.7%	-0.9%	-2.1%	-5.3%	-5.9%	-5.9%	+0.6%	
	number of days > 30 mm		1.4 days	1.7 days	+4.5 to +18%	+5 to +10%	+9 to +30%	+8.5 to +10%	+1.0 to +23%	+3.0 to +10%	+3 to +40%	+3 to +10%	+2.6%	
Solar radiation	mean amount		149 kJ/cm ²	153 kJ/cm ²	+2.1%	+2.1%	+1.0%	+5.5%	+0.9%	+5.5%	+5.5%	+9.5%	+2.4%	
	relative humidity		78%	77%	-0.6%	-2.0%	+0.1%	-2.5%	0.0%	-2.0%	-0.6%	-3%	+0.6%	
Humidity	potential evaporation (Makkink)		253 mm ²	266 mm ²	+13 mm ²	+5%	+7%	+6%	+11%	+5.5%	+8.5%	+9%	+2.8%	
	mean highest precipitation deficit during growing season ⁵		140 mm	144 mm	+4.5%	+20%	+0.7%	+3.0%	+1.9%	+1.6%	+50%	+1.6%	+1.9%	
Drought	highest precipitation deficit exceeded once in 10 years ¹		-	230 mm	+5%	+17%	+6.5%	+2.5%	+1.5%	+7%	+15%	+60%	-	
	mean amount		10.0 °C	10.8 °C	+1.1 °C	+1.3 °C	+2.2 °C	+2.3 °C	+1.8 °C	+1.5 °C	+3.8 °C	+3.8 °C	+0.21 °C	
Autumn	Temperature	mean	10.0 °C	10.8 °C	+1.1 °C	+1.3 °C	+2.2 °C	+2.3 °C	+1.8 °C	+1.5 °C	+3.8 °C	+3.8 °C	+0.21 °C	
	precipitation	mean amount	214 mm	245 mm	+31 mm	+14%	+13%	+7.5%	+7.5%	+9%	+6.5%	+12%	+9.2%	

In this revised edition (page), the figures for the W_L scenario around party are corrected. See for more information about this correction: www.knmi.nl/rapportage/2015/04/15/

FIGURE 4.25 An overview of future climate change in the Netherlands. The table shows variations for different climate indicators (e.g. temperature, precipitation, wind) considering four different scenarios (all combinations of two possible values for global temperature rise and change in air circulation pattern) and two time horizons (2050 and 2085) relative to the reference period of 1981-2010. Reprinted from KNMI (2015).

§ 4.4 Conclusion

In the previous sections the energy potential of the built environment, under the influence of local climate and existing urban context, has been examined. From this a set of climate-related and context-related boundary conditions is derived. They are presented as an enumeration of multiple strongly related environmental parameters, round up with points of particular interest in the development of the energy concept (Table 4.2).

ENVIRONMENTAL PARAMETER	POINTS OF PARTICULAR ATTENTION
Urban pattern, vegetation and solar geometry	<ul style="list-style-type: none"> – Solar access to building envelope (shadow casting, etc.) determines potential for passive and active solar strategies. In densely built areas solar harvest is limited at levels of the building skin low to the ground. The uppermost storeys and the roof can still be well exposed to the sun. – On-site vegetation can block sun access to the building, which can be beneficial to the purpose of solar shading.
Urban pattern, landform, vegetation and distribution of wind direction and speed	<ul style="list-style-type: none"> – Wind behaviour in urban canyon and urban canopy determines potential for natural ventilation and wind power. A high density causes natural air to flow over the building rooftops, while limiting the air flow at street level. – When no clear prevailing wind direction is available wind is best harvested using a strategy that is able to 'catch' wind from different directions. – Landform and vegetation may block wind access to the building, which can be beneficial to the purpose of wind screening.
Annual temperature distribution, soil composition and ground cover	<ul style="list-style-type: none"> – Energy exchange potential of shallow layers of the soil. Soil composition and (soil) temperature at shallow depths follows seasonal trends in air temperature of the location. Directly underneath the building the energy balance is also fed by heat flows from the building.
Average annual temperature, soil composition and groundwater flows	<ul style="list-style-type: none"> – Energy storage potential of deeper layers of the soil. Soil temperatures at depths of 10 m and more are quite stable and close to the average annual air temperature at the location. In addition, groundwater flows affect the energy balance of the soil, either boosting or blowing the heating (or cooling) potential for prolonged periods.
Air temperature distribution (extreme values, mean values) and solar geometry	<ul style="list-style-type: none"> – Primary steering factor of general thermal energy balance of the building. Use a quick-scan method to explore heating and cooling demands of an initial design.
Solar path in periods with high chance on overheating	<ul style="list-style-type: none"> – By using a quick-scan method the need for preventive measures according to the time of year and time of day can be mapped. – Fixed shading devices then block the solar radiation from corresponding sun angles.
Natural light access to the envelope	<ul style="list-style-type: none"> – Strategic use of daylight minimise the need for additional electric lighting.
Water presence, whether or not combined with vegetation	<ul style="list-style-type: none"> – The presence of water has a cooling effect on the direct surroundings due to the effect of evaporation.

TABLE 4.2 Climate-related and context-related boundary conditions and points of particular interest in the development of an energy concept.

This list acts as one of the starting points for the development of the building's energy concept. In the next chapter 5 the full delineation of the concept of climate-responsive design is expounded, resulting in the presentation of different design principles on how to harvest and harness the energy potential of a built environment. Following that list of design principles a set of design solutions is presented, as the actual implementation of the stated design principles in building design. The focus then shifts towards a set of climate-responsive building elements, design solutions in which structural or architectural implementation of climate-responsive design principles is brought to a maximum. The climate-responsive building elements on that list are studied in more detail in chapter 6, together with their energy potential estimation.

References

- Allard, F. [ed.] (1998) *Natural ventilation in buildings – a design handbook*. London, England: James & James.
- Buik, N., Stolk, P. and Willemsen, G. (2004) *Analyse van temperatuurmetingen in de Nederlandse ondergrond in Stromingen*, vol. 10, issue 4, pp. 13-22.
- Daniels, K. (2000) *Low-Tech Light-Tech High-Tech -building in the information age*. Basel, Switzerland: Birkhäuser.
- Davies, J.H. and Davies, D.R. (2010) *Earth's surface heat flux in Solid Earth*, vol. 1, pp. 5-24.
- Heusinkveld, B.G., Van Hove, L.W.A., Jacobs, C.M.J., Steeneveld, G.J., Elbers, J.A., Moors, E.J. and Holtslag, A.A.M. (2010) *Use of a mobile platform for assessing urban heat stress in Rotterdam in Proceedings of the 7th Conference on Biometeorology*, Freiburg, Germany.
- Kiehl, J.T. and Trenberth, K.E. (1997) *Earth's Annual Global Mean Energy Budget in Bulletin of the American Meteorological Society*, vol. 78, pp. 197-208.
- KNMI (2014) *KNMI'14: Climate Change scenarios for the 21st Century – a Netherlands perspective*; by Bart van den Hurk, Peter Siegmund, Albert Klein Tank (Eds), Jisk Attema, Alexander Bakker, Jules Beersma, Janette Bessembinder, Reinout Boers, Theo Brandsma, Henk van den Brink, Sybren Drijfhout, Henk Eskes, Rein Haarsma, Wilco Hazeleger, Rudmer Jilderda, Caroline Katsman, Geert Lenderink, Jessica Loriaux, Erik van Meijgaard, Twan van Noije, Geert Jan van Oldenborgh, Frank Selten, Pier Siebesma, Andreas Sterl, Hylke de Vries, Michiel van Weele, Renske de Winter and Gerd-Jan van Zadelhoff. Scientific Report WR2014-01, KNMI. De Bilt, The Netherlands: Author. <http://www.climatescenarios.nl>
- KNMI (2015) *KNMI'14 climate scenarios for the Netherlands, a guide for professionals in climate adaptation*. De Bilt, The Netherlands: Author.
- Mertens, S., (2006) *Wind Energy in the Built Environment – Concentrator Effects of Buildings*, Multi-science, Brentwood. PVGIS, European Commission, Joint Research Centre, Institute for Energy, Renewable Energy Unit.
- Pijpers-van Esch, M. M. E. (2015) *Designing the Urban Microclimate: A framework for a design-decision tool for the dissemination of knowledge on the urban microclimate to the urban design process*. Delft, The Netherlands: A+BE | Architecture and The Built Environment. Retrieved from <http://repository.tudelft.nl/islandora/object/uuid%3Adb37f8c4-c32d-42d7-8462-b2208a342184>
- Sluijter, R. [ed] (2011) *De Bosatlas van het klimaat*. Groningen, The Netherlands: KNMI, Noordhoff Uitgevers. <http://www.klimaatatlas.nl>
- Van Esch, M.M.E., Looman, R.H.J. and De Bruin-Hordijk, G.J. (2012) *The effects of urban and building design parameters on solar access to the urban canyon and the potential for direct passive solar heating strategies in Energy and Buildings* 47, pp. 189-200.
- Wu, J. and Nofziger, D. L. (1999) *Incorporating temperature effects on pesticide degradation into a management model in Journal of Environmental Quality*, issue 28, pp. 92-100.

5 Climate-responsive design

Within this chapter the definition of climate-responsive design is further established, by mapping the underlying principles and transforming them into actual design solutions. The chapter kicks off by bringing some clarity in the tangle of energy-related design language in order to give position to climate-responsive design (section 5.1). Next, the principles and key elements of bioclimatic design are explained, coming from both researchers and practicing architects (section 5.2). Bioclimatic design can be seen as a founding design philosophy for climate-responsive design. Subsequently, the chapter elaborates on the topic of climate-responsive design (section 5.3), including a discussion of relevant issues of responsive behaviour of building elements and that of spatial and structural design of dwellings. In section 5.4 the underlying design principles are presented followed by the creation of a categorized overview of climate-responsive building elements, as the actual technical integration of the before mentioned design principles in architectural and structural elements. This chapter finishes with the content requirements for the design support tool (section 5.5), deduced from the theoretical framework presented in chapter 2 and the gathered and generated knowledge of chapters 3 and 4.

§ 5.1 Introduction

Energy consciousness in building design can be characterized as the willingness to improve the energy balance of buildings; achieved from either one of the steps in the New Stepped Strategy (see section 3.2.2). Current focus on energy consciousness in building design has led to a proliferation of new technical terms. While all expressions share the common trend towards sustainable energy housekeeping, historic meanings are often embroiled or even falsely used. This section aims at avoidance of confusion from the use of different definitions.

Passive versus active systems

The term passive in architecture traditionally refers to the absence of active systems for climate control, where active systems can be defined as mechanical installations that need energy to operate. Nowadays passive design is often used to indicate designs that primarily consist of passive solutions, but does not necessarily rule out the use of supplementing active systems.

The broad spectrum of low energy design

Energy conscious design typically aims at a reduced primary energy use when compared to conventional design. Project examples that pursue more energy consciousness in their designs are commonly shared under the name of low energy design which does not specify strict goals in energy use.

Within the low energy design movement a follow-up step was to come to zero energy buildings; buildings that are completely self-sufficient and off-grid (i.e. not connected to communal energy services such as the electricity grid). However, nowadays zero energy buildings also cover net-zero energy or energy-neutral buildings that produce as much energy on an annual scale equal to their own energy demand. These buildings are still connected to communal energy facilities to overcome discrepancies in time between energy generation and consumption. The produced surplus energy is not stored for later use but delivered back to the grid. One step beyond net-zero energy buildings are energy plus buildings that produce a surplus of energy (from renewable sources) on an annual basis which is given back to the grid.

Both the net-zero energy concept and the energy plus concept are interesting concepts when surplus energy from one building can be made beneficial to another building during the transition towards a more energy-efficient built environment as a whole. Surplus energy can also become beneficial in mixed-use developments where the energy producing building can function as an energy hub on community scale or to suffice domestic mobility related fuel needs. However, there is little gain to be expected from energy producing buildings when they are considered on the scale of a single building and no specific purpose for the surplus energy is clearly defined.

The carbon movement

Following the carbon movement sustainable performance calculation nowadays takes the production of carbon dioxide as the normative parameter rather than just energy use. Zero carbon means so much as zero fossil energy. All building related energy is then generated from renewable resources; not necessarily generated on-site. In contrast to zero carbon, carbon-neutral buildings become net-zero producers where carbon emission is counter-balanced by some compensating measures; not necessarily on-site or even building related.

To add to the confusion the term of carbon-neutral is also used in a wider perspective which also includes the use of (building) materials and spans all activities within the whole life-cycle of the building. This includes also energy use or carbon emission during the construction and demolition phase.

Interaction between building and its environment

Hastings (1989) makes a distinction in three different ways of how a building can interact with the outdoor environment:

- With **climate-insensitive design** there is no interaction with the environment at all. The building operates indifferent from the climate it is set in. With such buildings most of the interior spaces have no direct contact with the outdoors and building services are provided mechanically.
- With **climate-combative design** the building ‘fights’ the outdoor environment, mainly through super-insulation. The building design does take local climate into account while it sets for the initial amount of insulation needed.
- With **climate-responsive design** the building acts as an environmental filter. A balance is found between the exclusion of unwanted forces and the admittance of the beneficial ones.

According to Hastings’ definition climate-responsive design puts an emphasis on the potential of buildings as being an intermediate between the indoor and outdoor environment. This intermediary function of the building is considered a key aspect in the realization of comfortable buildings as well, along with the allowance for human intervention in climate control to satisfy subjective needs (Fountain et al., 1996, Mahdavi & Kumar, 1996). In fact, comfort delivery that is more in tune with the dynamics of the natural environment also connects to the human preference for diversity and can have a positive effect on human health (Van Marken Lichtenbelt et al. 2014).

The natural environment or local climate is also inextricably connected to low energy design. Local climate is generally identified as one of three design parameters that heavily determine the energy use of buildings, together with building use or comfort demands and building design (Brown & DeKay, 2001; Santamouris, 2001). The influence of local climate has a dual character of being either repelled when undesired or employed when potential.

§ 5.2 Bioclimatic design as the foundation of climate-responsive design

In recent years various design philosophies have been developed that address to more energy consciousness in building design. Many of them state the importance of the creation of a built environment in harmony with the natural environment. The potential of natural energy sources in the field of low energy and comfortable design has been addressed many times before in both research and architectural practice and is commonly shared under the generic term of bioclimatic design. This has been mentioned in works by Olgyay and Szokolay and put into practice by Kristinsson and Yeang, among many others.

§ 5.2.1 Bioclimatic design in theory and practice

'Design with Climate' (Olgyay, 1963) can be seen as one of the founding books that restored interest in the incorporation of outdoor climate in building design. Already in the early 1950's Olgyay introduced the term bioclimatic design in architecture. Following his definition architectural design starts from a study into the building site and local climate. Objective quantities such as orientation, building form and shape, wind patterns and indoor conditions become parameters of design and architectural expression will be a reflection of that specific building site.

Szokolay (2008) elaborated on the science of architecture by presenting objective methods based on physical principles to determine the potential of natural energy sources in the creation of comfortable buildings. According to Szokolay the architect's aim should be the creation of healthy and comfortable indoor environments that use little or no energy other than from ambient or renewable sources. The task of the designer is fourfold: examine the local context (e.g. building site and climate), establish comfort limits, employ the building as much as practicable to meet these limits and, finally, complement with active systems.

Architect Ken Yeang takes the building as a system and also considers it as the intermediary between the indoor and outdoor environment. Many of Yeang's designs are high rise buildings which he considers as a vertical continuation of urban design. He mentions the potential of open systems where the building itself acts as an open barrier where undesired external forces are excluded and desired ones are admitted (Yeang, 1991). Within his theoretical framework of green design Yeang states three essential components for an ecological model of a designed system: a description of the built system itself, a description of the environment including the ambient ecosystem and natural resources, and the mapping of the interactions between the building and its environment (Yeang, 1995; Yeang, 2008).

Architect Jón Kristinsson is known for his many progressive designs based upon what he calls integrated design; the holistic physics approach to ecological building (Kristinsson & Van den Dobbelsteen, 2012). It forms the bridge between architecture and nature; without integrated knowledge of physics no true sustainable building can be designed that will sustain. He also considers occupants and local context as parameters of design (Figure 5.1).

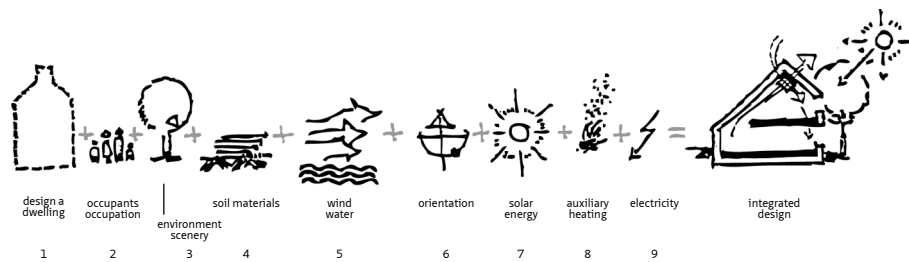

FIGURE 5.1 Integrated design as the holistic physics approach to ecological design. Adapted from Kristinsson (2002).

Many of Kristinsson’s designs were (and still are) ahead of their time. In 1976 a self-sufficient building for the municipality of Lelystad - designed but never built - integrates many design techniques of which some are generally adopted by now (Figure 5.2). The design features parabolic roof shells that mirror sunlight to thermal collectors in order to boost overall performance. Surplus heat in summer is stored underground for use in winter. Furthermore, the daylight strips in the roof structure includes a transparent foil that becomes reflective when the glass temperature rises above 30°C. The façades of the building get shading from different measures including balconies, deciduous vegetation and movable louvers. In order to reduce heat loss during the heating period thermal shutters can be placed in front of the windows.

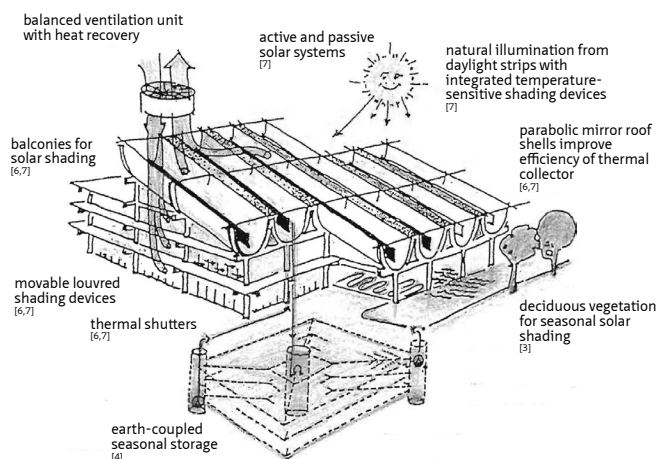

FIGURE 5.2 Design for a self-sufficient municipal office in Lelystad, the Netherlands (1976). Architect: Jón Kristinsson. Adapted from Kristinsson & Van den Dobbelsteen (2012). Numbers correspond to previous figure.

A study into the opportunities of energy performance improvement of social housing with the restrictions of a tight budget led to the development of 184 minimum-energy dwellings in Schiedam. The project covers 76 single family units and 108 apartments. The dwellings feature fixed solar shading, thermal shutters to reduce heat loss during the night, a balanced ventilation unit with heat recovery and air locks to reduce heat loss when one enters the house. With an EPC of 0.53 the dwellings scored after completion in 1984 better than the Dutch energy regulations that were put down in 2011, 26 years later.

§ 5.2.2 Other implementations of bioclimatic design

Many design concepts are based on the same bioclimatic design principles and therefore share some similarities. However because of different starting points the outcomes of design have some clear differences as well. In this paragraph the two rather well-developed design concepts of the Passive House and zero energy development (ZED) are looked into in order to create room for climate-responsive design in the current practice of energy conscious design.

Passive House

The Passive House concept is a well-known and rather popular concept based on passive design principles, but with a crucial role for active systems. It was developed in the early 1990s in Germany. Since the establishment of the Passivhaus Institut in 1996 the concept has been put into practice in many projects mainly situated in Germany and Austria.

According to the original definition¹⁶ a Passive House of residential type poses a maximum level for annual energy use for space heating of 15 kWh/m², complemented by other requirements for primary energy demand, air-tightness and heat exposure (Passivhaus Institut, 2014). The passiveness of the concept is tucked away in high thermal insulation, enhanced air tightness and the elimination of thermal bridges. The requirements are further met by the use of a highly efficient mechanical ventilation systems with heat recovery. In reference conditions internal heat production and heat recovery from the ventilation air is sufficient to meet heating demands during most time of the year. During the cold winter period some additional heating is obtained from an active heating system.

The concept of the Passive House is in its essence a low energy standard with a maximum value set for the energy used for space heating, leaving many design options open. The concept of the Passive House is feasible in any building function or size and applicable to both newly built and renovation projects.

ZED

ZED stands for zero (fossil) energy design development and was branded after the realisation of the mixed use development Beddington ZED (or BedZED) in 2002 in Sutton near London. The philosophy behind ZED is that the design, construction and refurbishment of developments should only use renewable energy sources with no direct carbon emissions (Dunster et al., 2008). The ZED design philosophy is put down into ZEDstandards, a set of guidelines. While the outcome of ZED design is determined by location and scale, the guidelines are only made specific to the scale of the development.

For ruralZED developments, i.e. low density residential development, the ZEDstandards are transformed into a base design concept with the possibility to upgrade that design to meet higher ambitions. In other words, the concept has a modular approach which allows an easy extension of the basic concept to meet more stringent demands or higher ambitions. The presented design options go along with the different ambition levels of the UK Code for Sustainable Homes (Crown, 2008) and goes all the way up the highest achievement of level 6, zero carbon sustainable construction (Figure 5.3).

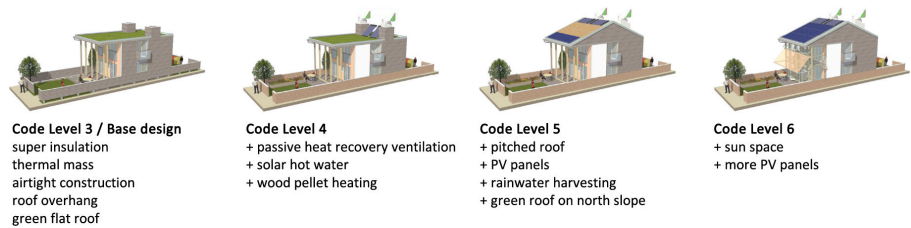

FIGURE 5.3 ruralZED base specification and full upgrade path to highest level of the UK Code for Sustainable Homes. Adapted from ZEDfactory (2010).

ZED developments are high performance catalogue units, focussing on self-builders or home developers that want high performance buildings at competitive prices. A lot of options to enhance the building performance are at the client's disposal. Some of them have a big impact on the aesthetics of the design, but apart from that the client can hardly exert any influence on the design which is rather independent of its context.

Discussion

The success of a Passive House leans heavily on the joint effort of high thermal insulation, enhanced air tightness and mechanical ventilation systems with heat recovery. This results in a building that turns inwards and has little interaction with its environment. The concept however leaves much to the architect when it comes to architectural design. This is in high contrast to the almost completely pre-designed concept of ruralZED. However, given the little room the architect has within ruralZED the ambitions certainly raise the bar for sustainable design. Climate-responsive design aims at a balanced design between architectural freedom and highly evolved energy performance.

§ 5.3 Climate-responsive design

Climate-responsive design can be regarded as an encompassment of the synthesis of the following three principles:

– Energy exchange with the environment for comfort provision

Climate-responsive design is about provision of comfort to building occupants. Available natural energy flows can often be made beneficial for climate control without complex interference. Acknowledge the fact that the outdoor environment has the potential of being a source or sink of energy to buildings. Collect whatever is needed to meet your energy demands.

– **The building as a responsive system**

Responsive means acting in response, as to some stimulus. In climate-responsive design the climate is the stimulus. Building space and mass can function as an intermediary between the indoor and outdoor environment, allowing exchange of energy between the two environments while acting as an environmental filter. The building design as a whole (e.g. shape, plan, enclosure, elements, use of materials and the installations) is considered with certain openness and forms the intermediary between the indoor and outdoor environment. A climate-responsive building responds to changes in climatic conditions, both internal and external, and to occupant behaviour.

– **Far-reaching architectural or structural integration**

Climate-responsive design is about interaction between the indoor and outdoor environment. The design choices concerning space and mass have a significant effect on the applicability of an integrated energy infrastructure.

Climate-responsive design embraces a strategy in building design where it extends bioclimatic design principles of form and envelope design to structural and architectural elements that actively harvest potential energy flows. Climate-responsive design is not primarily about minimising energy demand of buildings. It is about creating a comfortable and healthy building that benefits from the potential of the natural energy resources in the built environment.

§ 5.3.1 **The energy balance of a climate-responsive building**

Climate-responsive design takes advantage of the natural energy sources present in the built environment for passive or low-energy comfort provision. The building space and mass act as an intermediary, where the indoor environment is controlled in close interaction with dynamic outdoor conditions.

Since these dynamic outdoor conditions will not always be in phase with comfort demands, the building needs to employ complementing treatment strategies such as energy conservation, distribution, buffering, recovery and storage. Whole building design will combine multiple techniques that together result into a comfortable building with an effective energy balance primarily fed by natural energy flows (see [Figure 5.4](#) and [Table 5.1](#) and [Table 5.2](#)). The energy sources comply to the climate resources presented in the previous chapter, complemented with energy recovery from waste flows, considered an essential part of energy-efficient design - and thus climate-responsive design.

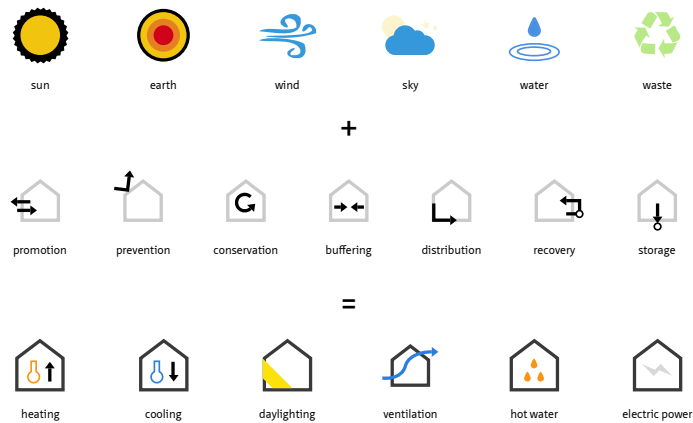

FIGURE 5.4 The energy balance of a climate-responsive building where the harvest of natural energy sources and complementing energy treatment strategies provide the energy needs for comfortable living.

	ENERGY STRATEGY TREATMENT	DESCRIPTION
	promotion	The admittance of external energy forces to enter the building, but also aid undesired energy flows in exiting the building.
	prevention	To keep undesired external energy forces from interfering with the indoor climate.
	conservation	The capacity of the building to retain energy within the building. Most common measures include prevention of heat loss through infiltration and transmission.
	buffering	The capacity of the building to lessen the direct impact of fluctuations in outdoor energy flows.
	distribution	The transportation of energy throughout the building from locations with an abundance to locations that lack energy.
	recovery	The partial or full regain of energy from waste flows.
	storage	The ability to bridge discrepancies in energy supply and demand by keeping energy separate from the building which is retrievable at any desired time.

TABLE 5.1 Treatment strategies to realise an effective energy balance from external energy flows.







	COMFORT DEMAND	DESCRIPTION
	heating	The provision of space heating, including strategies to prevent indoor temperatures to drop below the lower boundary of the comfort zone beside the actual input of energy to increase indoor temperatures.
	cooling	The provision of space cooling, including strategies to prevent the indoor temperature to rise above the upper boundary of the comfort zone next to the actual input of energy to cool down the building.
	daylighting	The provision of comfortable amounts of daylight within indoor spaces.
	ventilation	The provision of an healthy indoor air quality by the introduction of fresh air and thus the removal of stale air from indoor spaces.
	hot water	The generation of hot water for domestic use, e.g. shower, cooking, etc.
	electric power	The generation of electricity for domestic use.

TABLE 5.2 Comfort demands to be met by a climate-responsive building.

The effectiveness of climate-responsive design and the strategy to follow is heavily related to local climate conditions and building use. For example, intermittently used buildings that have a high internal heat production may have a high cooling load which calls for a strategy that includes passive cooling measures but when the predominant energy demand is attributed to space heating this would call for a different strategy that harvests the free heat gains, has an adequate system of energy storage and distribution and minimizes heat loss.

§ 5.3.2 The building as a responsiveness system

Definition of response:

'Response; 1 (Psychology) An action or feeling which answers to some stimulus or influence; 2 The way in which an apparatus responds to a stimulus or range of stimuli.'
(Oxford English Dictionary; <http://www.oed.com>)

From this definition responsive behaviour can be defined as a readily reaction to some kind of stimulus. The reaction is a desired change of state in order to maintain certain functionality. This change of state can either be an architectural change of elements or a physical change of material characteristics. In the case of climate-responsive design the functionality to maintain is comfort provision. The stimuli are changing indoor comfort demands and variable outdoor conditions.

The focus of this research is on climate-responsive building elements, design solutions that have a certain degree of structural or architectural integration and incorporate some kind of dynamic behaviour (Figure 5.5).

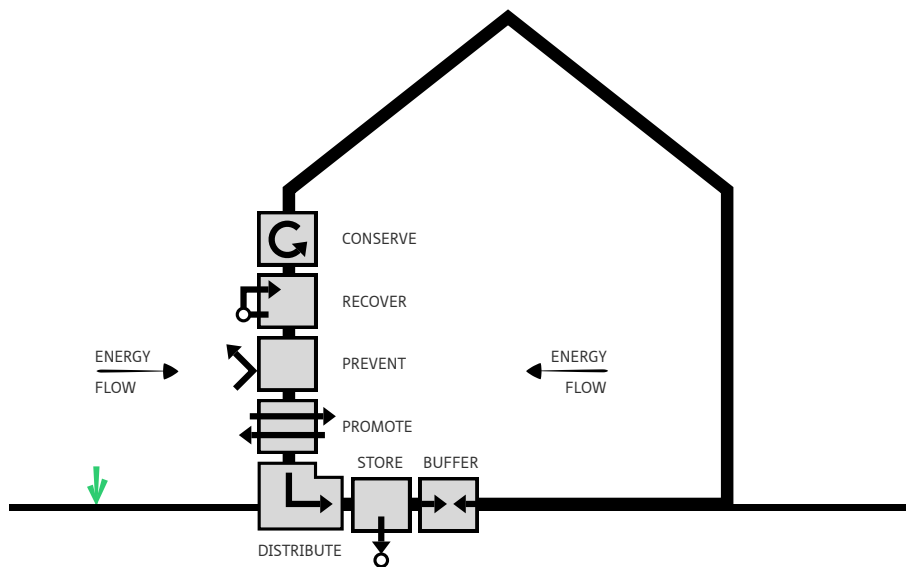

FIGURE 5.5 The building can interfere with the natural energy flows in different ways.

There are three different types of responsive methods: non-adaptable measures, adaptable measures and smart materials. The non-adaptable measures may seem as a paradox within the scope of responsive behaviour but it is part of climate-responsive design because it concerns energy-saving measures that focus on comfort provision while managing ambient energy flows (e.g. insulation or thermal mass). Adaptable measures change state by some sort of intervention in the form of active control. In its most simple form the state is changed through user-intervention (e.g. opening windows, lowering blinds). This manoeuvre can also be automated using for example time switches, thermostats or other sensors. The use of intelligent systems that include learning curves or anticipated behaviour may increase performance of adaptable measures. Unlike intelligent systems, which need some computational effort to operate, smart materials have some kind of embedded intelligence so that it is capable of being controlled in such a way that its response and properties change under a certain stimulus (IOPscience, 2014).

The (climatic) stimuli that trigger responsive behaviour can be either fixed, repetitive or real-time values. Design solutions that are designed to respond to fixed values have their function tuned to climate parameters such as average annual ambient temperature, a certain sun angle or a prevailing wind direction. Design solutions that responds to repetitive values have their functionality tuned to diurnal cycles in solar offer, for example. With real-time climatic stimuli the climatic parameter at a certain time, e.g. measured temperature, solar intensity or wind direction, is the indicator.

Not all combinations of response and stimulus are possible. Smart materials respond to dynamic, real-time conditions as opposed to non-adaptable measures that are non-responding to real-time conditions. Figure 5.6 visualises the whole spectrum of responsive behaviour in climate-responsive design.

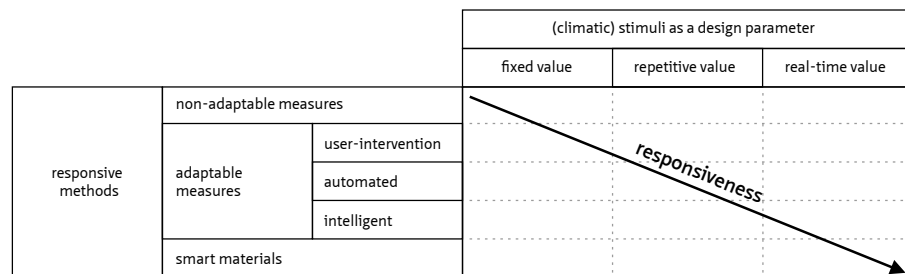

FIGURE 5.6 Levels of responsive behaviour as a function of the climatic stimuli and responsive methods.

§ 5.3.3 Degrees in structural and architectural integration

A building as a whole can be seen as an enclosed space (or collections of spaces) in which humans can exploit their activities. The enclosure of a space acts as some kind of barrier between the indoor and outdoor environment. However, in climate-responsive design it is preferred to consider this enclosure as an intermediary, which puts an emphasis on the possibilities of interaction between the indoor and outdoor environment. The design choices concerning space and mass have a significant effect on the applicability of an integrated energy infrastructure.

Based on primary function the enclosure can be divided into four main layers: structure, skin, interior and energy infrastructure (Leupen, 2002; Leupen & Mooij, 2008).¹⁷

- The **structure** is the composition of walls, floors, columns and beams that together guarantee stability and conduct the loads to the foundation of the building. The structure also decides on the initial space and mass distribution.
- The building **skin** is the primary separation of the interior from the exterior.
- The building **interior** consists of internal walls and openings that decide on the arrangement of internal spaces and internal routing, and the actual finishing of internal surfaces.
- The **energy infrastructure** is the whole set of facilities for distribution and supply of energy, water and air. It is part of the technical infrastructure that also includes the distribution of information, but this is outside the scope of this research.

There is no strict division between these layers and combinations between different layers are seen very often in building practice. This research examines the boundaries of the ability of the three layers structure, skin and interior to contribute to the functionality of the energy infrastructural layer or even become an integral part of that layer. These four layers together then function in a mutual and interlinked way that can further exploit energy harvest and delivery.

17

Similar divisions have been made that address to other aspects of buildings. Architect Francis Duffy introduced the concept of shearing layers and made a distinction based on the longevity of building components: 'shell', 'services', 'scenery' and 'set'. Brand (1994) elaborated on this with his shearing layers of change, a reclassification of Duffy's distinction: 'site', 'structure', 'skin', 'services', 'space plan' and 'stuff'. Leupen (2002) and Leupen and Mooij (2008) dropped site and stuff since they think it is not part of the building itself.

Structure

The building structure is the composition of multiple elements that as a whole guarantee stability and conduct the loads to the foundation of the building. Typically structural elements can be divided into two main categories: frame elements (e.g. column and beam) and monolith elements (e.g. solid wall and floor). The actual building structure can be a combination of elements from both categories (Figure 5.7).

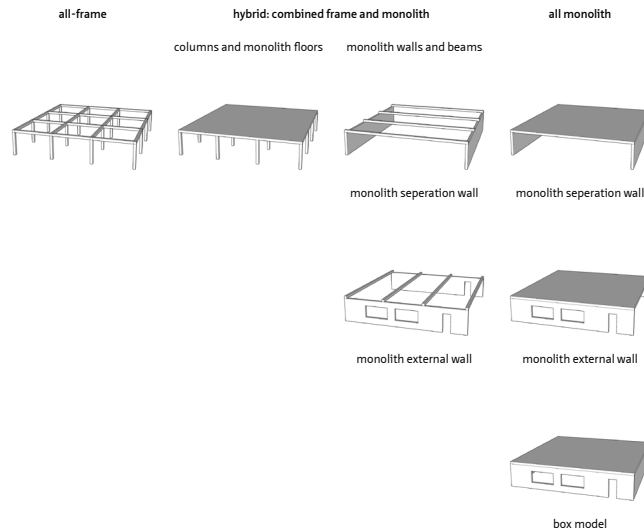

FIGURE 5.7 Building structure variation based on frame and monolith elements. A separation wall separates two indoor spaces. An external wall separates the indoor environment from the outdoor environment. After Leupen & Mooij (2008).

The structure of a building can be realised from different materials. Monolith elements are constructed most commonly from concrete (both vertical and horizontal elements) or brickwork (in principle only vertical elements). The use of concrete allows for rigid structures which result in bigger heights and larger spans. Framed structural elements are commonly made from concrete, steel or wood.

The chosen building structure defines the initial spatial layout (and mass) of a building. With all-frame construction and columns with monolith floors the spatial layout of each storey has almost no boundaries while with monolith walls and beams and all-monolith construction the options are more limited. Although openings can be made in monolith wall and floor elements, their possibility depends on dimensions and materialisation of the element.

There is a strong relationship between space and structure. Figure 5.8 shows a wide variety of possibilities to erect a simple building form from different structural elements, but still allow variety in the arrangement of individual zones. Moreover, the many possibilities show a wide variety in orientation and direction of responsive elements and their potential for harvesting energy in the building's space and mass and transporting it throughout the building.

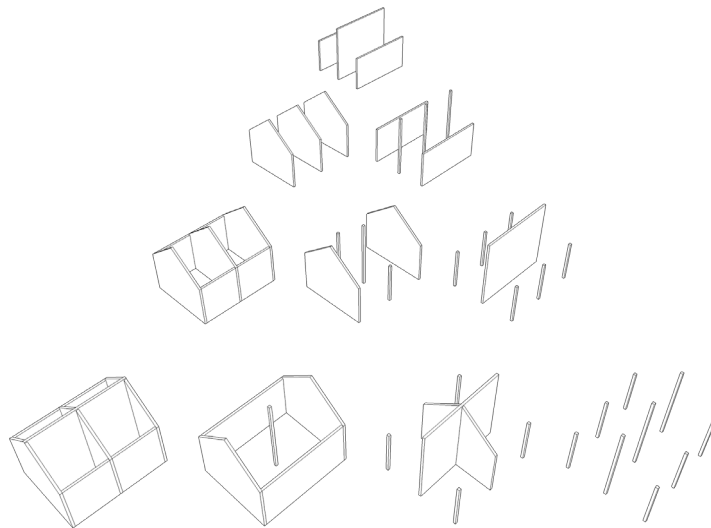

FIGURE 5.8 Relation between space and structure; composition of structural elements show a wide variety of possibilities to construct a single building form, here a rectangular plan with gable roof. After Sackman (1988).

Especially in housing the composition of individual elements and components has often a repetitive character of both single elements and whole structural concepts. The monolith separation wall structure is the most common structural concept used in the Netherlands; a relic of the post-war industrialised process of mass-construction of dwellings and the answer to uniform spatial layout of dwellings. These monolith structures are swiftly constructed and relatively cheap when produced in larger series. Furthermore, the concrete separation walls suffice requirements on sound insulation and fire-safety.

Structural elements are designed to bear loads and conduct them to the foundation. The loads to bear can be split into permanent and variable loads. Permanent loads include the element's own mass. For both economical and architectural reasons floor elements are designed to be less massive while still being able to span a certain distance. Where mass is left out, space becomes available for technical infrastructure (e.g. pipes, ducts and wires).

Skin

The skin of a building is the primary separation between indoor and outdoor and serves multiple functions (e.g. rain protection, daylight admission, outside view, thermal or sound insulation). To serve all these different functions, the skin is often composed of different layers. Massive layers generally consist of a single material and are self-supporting (e.g. brickwork or concrete) opposed to framed layers that are non-self-supporting and therefore need a supporting structure.

Three main types in the composition of building elements and combined functionality can be distinguished: segregation, incorporation and amalgamation (Hegger et al., 2008; [Figure 5.9](#)). When two (or more) building elements and their functions are clearly separated one speaks of segregation. Take for example an external waterproof cladding mounted onto a structural component. Incorporation is achieved when two (or more) elements with distinct functions are combined but practically function as a single element. Consider for example a framed wall with thermal insulated infill. Amalgamation is obtained when one element fulfils two (or more) different functions. Structural elements such as a load bearing monolithic wall can simultaneously act as the building skin.



1 With segregation two (or more) elements and their functionality are clearly separated.



2 With incorporation two (or more) elements with distinct functions that particularly function as a single element.



3 With amalgamation one element fulfils multiple functions.

FIGURE 5.9 Three main types of composing building elements and combined functionality: segregation, incorporation and amalgamation.

To improve or extend the functionality of typical (or existing) building components, new layers can either be added to an existing configuration, providing the whole configuration with new or improved functionality, or can be partly or completely substituted by new layers ([Figure 5.10](#)). This has potential as a strategy for the employment of climate-responsive design principles in renovation projects.

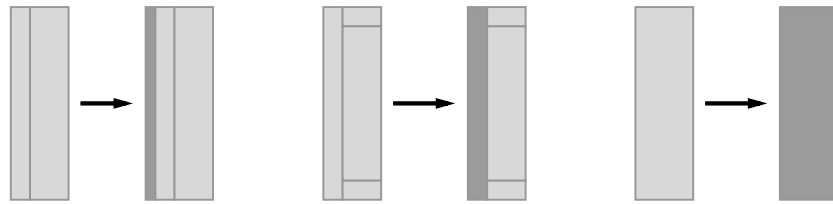

1 Addition of layers.

2 Partial substitution of layers.

3 Complete substitution of layers.

FIGURE 5.10 Three distinct types of changing layers.

Interior

Interior elements include the spatial arrangement by placing internal walls and openings. It also includes the covering of the floor, wall and ceiling. Unlike former times structural elements are nowadays often completely hidden from view. The interior finish has significant impact on the quality of indoor spaces and can be used to fine-tune visual, thermal, hygric and acoustical performance.

Within most housing developments it is common practice that most of the interior, except for final covering of the floor and the wall in all but the wet zones, is determined by the project developer or the housing cooperative, and not the future occupant. The contribution of a future home owner multiplies when the home owner is known in the early stages of design or construction. However, their options are often still limited to pre-selected elements. Only with design of private houses it is more common practice that the architect consults with the home owner when deciding on design, interior finish and furnishing.

Energy infrastructure

The energy infrastructure contains the whole set of facilities for internal distribution of energy, water and air. The energy infrastructure is a layer from more recent times. Typically this layer is a plain distinctive layer that consists of a complex network of ducts, pipes and wires controlled by one or more installations placed in a service room. Most of the technical infrastructure is nowadays hidden from view in dedicated spaces and by interior finish (e.g. shafts, wall channels, false ceilings, etc.).

The expanding network of the indoor energy infrastructure has become more and more disordered. The need to simplify this complexity has led to different design solutions that increase the manageability of the technical infrastructure during the construction phase and improve the flexibility to meet altered requirements due to

technical innovation or a change in building use. This can be done both on the scale of the building as on the scale of a single building element. The Concept House and the energy column are presented here for illustration purposes.

The general idea behind the Concept House is to deliver plus-energy buildings for high density developments. In order to realise plus-energy in the long run the Concept House aims for an increase of the uniformity of the energy infrastructure. The Concept House clusters (most) components of building service delivery into a single unit included in the sanitary core (Figure 5.11). The adoption of standard elements ensures a simplified connection to both community services and communal building facilities such as solar cells on the roof. By doing so the building is ready for implementation of future energy delivery and supply systems. Internally the energy infrastructure is embedded in floor and wall elements that allow for more flexibility in the delivery of different services (Asselbergs et al., 2010).

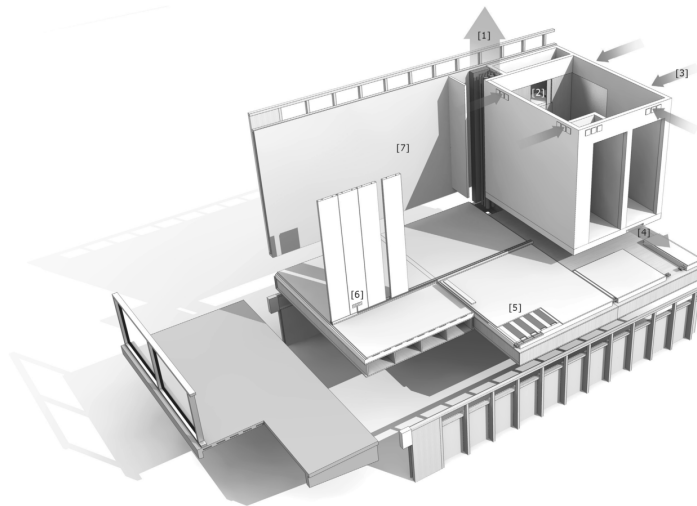

FIGURE 5.11 The Concept House features a single cluster of building service delivery that connects to community services and possible communal building facilities (1, 2). Internally, energy infrastructure is embedded in floor and wall elements that allow for more flexibility (4, 6). Reprinted from Asselbergs et al. (2010).

The energy column manages something similar on the scale of a single building element. The energy column combines vertical transportation of ventilation air, information and electricity in a single structural element. Ventilation air is then distributed throughout the storey from a network of ducts embedded in the massive floors and delivered to the space from outlets in the false ceiling. Data and electricity can be tapped from special sockets in the lower end of the energy column. The general idea behind the energy column is to maximise flexibility of the spatial plan (Figure 5.12).



FIGURE 5.12 First application of energy columns in the new Stedelijk Gymnasium in Utrecht, the Netherlands by Thomas Rau. The energy column is developed in collaboration with JVZ and Grontmij. Reprinted from RAU (2009).

Both the Concept House and the energy column address future flexibility; flexibility with respect to future service delivery and flexibility of spatial layout. These concepts focus on clustering and uniformity rather than exploring the potential of structural and architectural layers to become part of the energy infrastructure, which is a fundamental aspect of climate-responsive design.

§ 5.3.4 Architectural integration of energy infrastructure

The implementation of (new) infrastructural subsystems in building design may have considerable impact on its architecture. Combining subsystems and design has three distinct forms: addition, integration and adaptation (Hegger et al., 2008; Figure 5.13). With addition the subsystem is considered separately from the design. The infrastructural subsystem is designed for optimised individual performance and merely considers the building as a supportive structure. With integration the subsystem follows the design. This may affect its individual performance but lessens the impact on the architecture. With adaptation the design follows the (optimised) subsystem. This can lead to new architectural concepts.

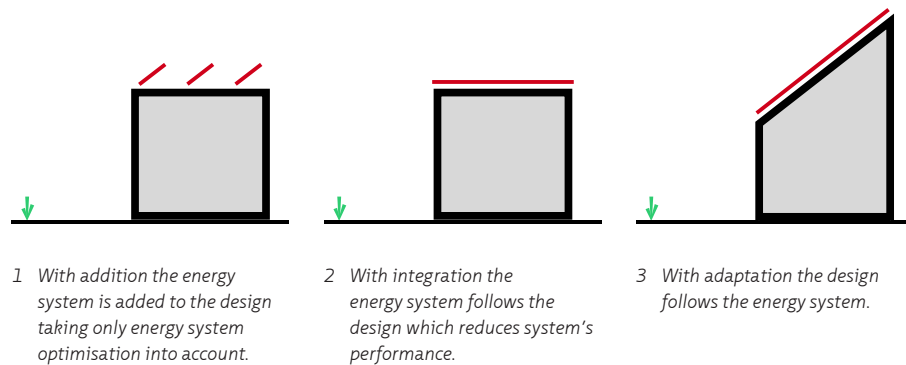

FIGURE 5.13 Degrees of architectural integration of energy infrastructure in building design: addition, integration and adaptation.

The decision to what degree energy infrastructure is to be architecturally integrated is a choice for the architect. Buildings can be intentionally designed as 'ordinary' buildings by camouflaging the sustainable elements or, on the contrary, can be manifested with sustainable elements as a design feature and give the building a high sustainable visibility factor.

One issue of the architectural integration of energy infrastructure is the difference between material and system cycles during the life span of a building. Over the lifespan of a building some parts will be replaced more frequently than others (Figure 5.14).

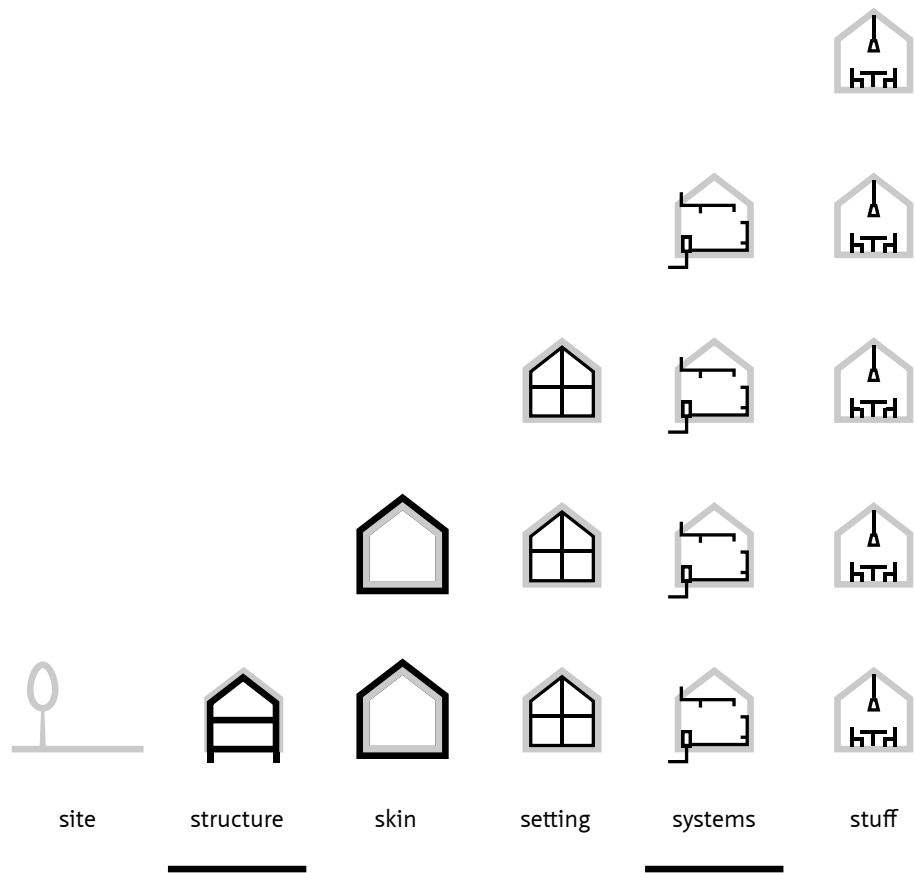

FIGURE 5.14 The material recovery chart shows the number of times materials and systems cycle through a building during lifetime. After Brand (1994).

Except for the site (no cycle) and the structure (single cycle) other elements (such as skin, setting, systems and stuff) may cycle more than once. An integrated solution needs to answer to the minimal cycle of the structural part, either by lengthening the cycle of the systems part or by allowing its easy disassembly. The first option is probably the preferred option for climate-responsive design.

§ 5.4 Climate responsive design principles and solutions

In the previous section the concept of climate-responsive design has been shaped. In this section this concept is further made concrete by defining a set of design principles, as the conceptual relations between energy source, energy treatment and comfort demand. From these principles a set of design solutions, as the contextual, architectural or technical implementations of these design principles into an actual design, is derived.

This section will finish with the presentation of a non-exclusive and non-exhaustive set of climate-responsive building elements - design solutions that are characterized by a far-reaching integration of energy harvesting methods into structural and architectural elements - since that is the main topic of this research.

§ 5.4.1 Climate-responsive design principles

Many comfort aspects can be met directly from harvesting or adverting natural energy flows, while others use some energy treatment strategy. A non-exhaustive set of different design principles is schematically presented in a matrix (Table 5.3, Table 5.4) and shortly described in Table 5.5.

	 heating	 cooling	 daylighting	 ventilation	 hot water	 electric power
 promotion	passive solar heating earth coupling	earth coupling natural cooling	natural illumination	natural ventilation	solar hot water geothermal hot water	solar power wind power
 prevention		solar shading	solar shading			
 conservation	thermal conservation	thermal conservation				
 buffering	thermal buffering	thermal buffering				
 distribution	thermal distribution	thermal distribution	daylight distribution			
 recovery	transmission heat recovery ventilation heat recovery				effluent water heat recovery	
 storage	thermal energy storage	thermal energy storage			hot water storage	

- Ventilation heat recovery is about recovering valuable heat from stale air flows. It is therefore part of a heating strategy and not of a ventilation strategy.
- Effluent water heat recovery is about recovering valuable heat from waste water flows. Since in current practice the recovered heat from effluent water streams is directly transferred to fresh water streams it is here categorized as a strategy for the provision of domestic hot water.

TABLE 5.3 Matrix of climate-responsive design principles presented as comfort provision against energy treatment.









	 heating	 cooling	 daylighting	 ventilation	 hot water	 electric power
 sun	passive solar heating	solar shading	natural illumination solar shading	natural ventilation: solar-driven	solar hot water	solar power
 earth	earth coupling	earth coupling			geothermal hot water	
 wind		natural cooling: natural air cooling		natural ventilation: wind-driven		wind power
 sky		natural cooling: night-sky cooling				
 water		natural cooling: evaporative cooling				
 waste	transmission heat recovery ventilation heat recovery				effluent water heat recovery	

TABLE 5.4 Matrix of climate-responsive design principles presented as comfort provision against energy source.

DESIGN PRINCIPLE	DESCRIPTION
passive solar heating	The principle of passive solar heating is based on the collection of short-wave solar radiation in (building) mass that in return disperses long-wave heat radiation that can be used for space heating.
earth-coupling	The general idea behind earth-coupling is to take advantage of the earth's large thermal storage capacity. Ground temperatures are quite stable at relatively small depths and are quite similar to the local annual average ambient temperature. Near the surface ground temperatures are more influenced by dynamic ambient conditions.
night-sky cooling	The effective temperature of a sky at night is typically much lower than ambient conditions. Therefore buildings cool down at night by radiating heat to the sky. This phenomenon also occurs during daytime but is then levelled out by solar radiation.
natural air cooling	Natural air flows can be used to remove unwanted heat from a building by flushing the building with large volumes of (cool) air. Natural air cooling is based upon the natural ventilation principle of cross ventilation: openings on both sides of the building allow natural occurring winds to pass through the building carrying the heat along.
evaporative cooling	Evaporative cooling is based on the fact that energy is needed for the evaporation of water. If this energy is withdrawn from the building, it will instantly cool down the building. Just the presence of groundwater or surface water will bring about a cooling effect on its direct surroundings. Due to its high thermal capacity, water has great potential as a heat sink.
natural illumination	Transparent and translucent openings allow natural light to illuminate adjacent spaces. Natural light can be split into two parts: sunlight and daylight. Sunlight is direct solar radiation and daylight is diffuse solar radiation, although different terms are used in literature.
natural ventilation	Natural air flow is induced due to differences in pressure. The driving forces of these pressure differences may either be differences in air temperature or wind flow around a building. Both concepts can be made beneficial to naturally ventilate buildings.
solar hot water	Solar radiation can be used to directly heat water for domestic use. In a solar hot water system, water circulates through a solar collector device which is heated by the sun.
geothermal hot water	At greater depths the temperature of the soil will increase. Water trapped at large depths down to 2000m can reach temperatures up to 60 °C or more. Depending on geothermal activity, elevated temperatures can even be reached much closer to the surface. In principle this source can be used for domestic hot water supply by extracting the hot water or its heat from the soil.
solar power	With photovoltaics sunlight is directly transformed into electricity. The principle is based on the photoelectric effect: passing energy contained in sunlight particles (i.e. photons) to electrons in physical matter.
wind power	Wind power is the conversion of wind into any other useful form of energy. Wind turbines harvest the wind to generate electricity.
solar shading	Transparent openings allow natural light to enter the building and provide occupants with a view outside. At the same time large sun-facing openings can be subjected to excessive amounts of solar radiation at certain moments which could lead to discomfort due to either overheating or unpleasant levels of light. Different types of solar shading are available to eliminate these undesired effects.
thermal conservation	Thermal conservation strategies aim at reducing heat losses both from transmission and infiltration.
thermal buffering	Thermal buffering is the capacity of a material to store heat, either from direct solar radiation or from passing air flows. As the result of this buffering behaviour indoor temperature swings are smoothed. In addition, energy is stored during the day and released during the night. This will lower the temperature drop during the night and thus the desired amount of heat required for the next day.

>>>

DESIGN PRINCIPLE	DESCRIPTION
thermal distribution	Energy can be distributed throughout the building to provide places which lack desired energy levels at some moments with energy from places where there is an abundance. Energy can be transferred by coupling air flows or with aid of a transport medium embedded in structural elements.
daylight distribution	Daylight redirection and distribution can see to it that desired illumination levels are met in the back of deep rooms or at spaces that are placed within the interior of a building that have no windows.
transmission heat recovery	In addition to a strategy of transmission loss reduction (see thermal conservation) the thermal energy from transmission heat flows can also be recovered.
ventilation heat recovery	The removal of stale air from a building also incorporates the removal of useful (thermal) energy. This thermal energy can be (partly) regained from the waste air flow and passed onto incoming fresh air flow, for instance. This reduces, or can even eliminate, the need for auxiliary heating of fresh air.
effluent water heat recovery	The removal of effluent water flows often implies the removal of thermal energy that can be put to use when recovered. Such waste flows include the drainage from toilets, showers or bath tubs, dish washers, washing machines and sinks.
thermal energy storage	Thermal energy can be stored to bridge discrepancies in energy supply and demand. With energy storage energy is stored 'separate' from the building mass and space and is retrievable on demand. The cycle of storage and retrieval of thermal energy can vary from diurnal to seasonal cycles.
hot water storage	Hot water storage techniques ensure that (solar) hot water is available at any time, even during periods with limited or no sunshine.

TABLE 5.5 Short description of climate-responsive design principles.

A next step is to translate the climate-responsive design principles into design solutions that form the architectural implementation of the design principles in an actual design.

§ 5.4.2 Climate-responsive design solutions

Climate-responsive design solutions are the contextual, architectural or technical implementations of the design principles into an actual design and can be divided into six categories (site planning, building form and layout, skin, structure, finish and (integrated) building service) that cover various dimensions in planning and construction (Table 5.6).











CONTEXTUAL SOLUTIONS	
 <p>site planning</p>	<p>Site planning includes the exploration of the proposed building site with the goal to benefit from existing or planned vegetation, water bodies and landform. The building site should also be considered in its urban context to map possible obstruction from nearby objects such as buildings.</p> <p>examples: shading from on-site vegetation, cooling potential of shaded areas and nearby water bodies, earth shelter (e.g. (partial) buried buildings that are protected from harsh conditions or exploit the earth's large thermal capacity).</p>
 <p>building form and layout</p>	<p>Through optimisation of building form and layout the energy potential of the built environment can be harvested where it is offered through careful selection of building form and orientation, or can be created from the design of outdoor zones with intermediate climate conditions. At the same time undesired energy flows can be limited through compact building design, thermal zoning and clustering.</p> <p>examples: compact design, thermal zoning, buffer zone (i.e. atrium)</p>
ARCHITECTURAL SOLUTIONS	
 <p>building skin</p>	<p>The building skin is the foremost intermediate between indoor and outdoor climate. The design of the envelope includes decision-making on insulation levels, permeability, material selection and the arrangement of transparent openings.</p> <p>examples: airtightness, (super)insulation and climate-responsive building elements such as sun space, solar chimney, thermal shutter</p>
 <p>building structure</p>	<p>The building structure has a load bearing function but also predetermines spatial layout and the location and orientation of massive elements.</p> <p>examples: climate-responsive building elements such as energy piles, thermo-activated elements</p>
 <p>building finish</p>	<p>The building finish (e.g. coverings of floors, walls and ceilings, glass treatment, etc.) has a fine-tuning effect on visual, thermal, hygric and acoustical qualities of indoor spaces.</p> <p>examples: reflective finishing, lime stucco</p>
TECHNICAL SOLUTIONS	
 <p>(integrated) building services</p>	<p>Building services are complementing components that have the sole purpose of energy harvest, distribution and delivery. In common practice building services often act as stand-alone component but they exist with different degrees of architectural integration. The building services considered in climate-responsive design have a high degree of architectural integration.</p> <p>examples: building integrated systems such as solar air collector, solar thermal collector, photovoltaic cells and urban wind turbine, and non-integrated systems such as deep-layer earth coupling, ground-coupled ventilation and vertical heat exchangers.</p>

TABLE 5.6 Categorization of climate-responsive design solutions into contextual, architectural and technical solutions.

As mentioned earlier the focus of this research is on climate-responsive building elements, as the architectural climate-responsive design solutions that also fulfil a structural or architectural function. However, the contextual and technical climate-responsive design solutions will be taken into consideration throughout the remainder of this section to illustrate and emphasize the integral character of climate-responsive design.

Table 5.7 shows a non-exhaustive overview of climate-responsive design solutions, categorised according to the (predominant) underlying design principle and the solution type (contextual, architectural or technical).

The main focus in this research is on climate-responsive building elements (highlighted in table 04 with a black border) which are characterized by a far-reaching integration of energy harvesting methods into structural and architectural elements. The remainder of this chapter will put emphasis on these design solutions and its characteristics, starting with the presentation of an overview of identified climate-responsive building elements.

	CONTEXTUAL		ARCHITECTURAL			TECHNICAL
	 site planning	 building form and layout	 building skin	 building structure	 building finish	 (integrated) building services
passive solar heating			direct solar gain system sun space	thermal storage wall		warm air collector
solar shading	shading from on-site vegetation		switchable window system + external solar shading light shelf +	structural shading device	printing	
natural ventilation			solar chimney wind catcher			
natural illumination			switchable window system + translucent insulation +			light pipes optical fibres
solar hot water						solar thermal collector
solar power						photovoltaic cell
night-sky cooling						
natural air cooling	cooling from shaded areas cooling from water bodies					
wind power						urban wind turbine
earth-coupling	earth shelter +		earth shelter +	direct contact foundation slab energy piles absorber diaphragm wall foundation slab with absorber lines		deep-layer earth coupling + ground-coupled ventilation
geothermal hot water						deep-layer earth coupling +
evaporative cooling			roof pond			
thermal conservation		air lock airtightness compact design thermal zoning wind screening	adaptable insulation thermal shutter translucent insulation +			
thermal buffering				thermal mass thermo-activation +	phase change material	

>>>







	CONTEXTUAL		ARCHITECTURAL			TECHNICAL
	 site planning	 building form and layout	 building skin	 building structure	 building finish	 (integrated) building services
thermal distribution			cavity wall heating	hollow core ventilation thermo-activation +		
daylight distribution			light-redirecting window system light shelf +			optical fibres
transmission heat recovery			boundary wall heat recovery dynamic insulation			
ventilation heat recovery						breathing window
grey water heat recovery						
thermal energy storage						
hot water storage						

TABLE 5.7 Overview of climate-responsive design solutions, categorised according to the (predominant) underlying design principle(s) and the solution type (contextual, architectural or technical). Solutions marked with a + occur more than once in the matrix.

§ 5.4.3 Climate-responsive building elements

The considered climate-responsive building elements are gathered in [Table 5.8](#) and shortly described in [Table 5.9](#). The presented overview is not intended to be an exhaustive list of climate-responsive building elements. These design solutions are gathered based on extensive literature research and analysis of numerous building designs and project examples. The climate-responsive building elements are categorized according to the relevant building system (structure or skin), building element (construction pile, ground floor slab, column/beam, load bearing wall/floor, opaque façade, transparent/translucent façade or roof) and service delivery (heating, heat loss limitation, cooling, overheating prevention, ventilation, precondition ventilation air or daylight control).

		building skin			building structure			
		opaque façade	transparent / translucent façade	roof	subsurface foundation elements	ground floor slab	column / beam	load bearing wall / floor
 heating	promotion provide space heating	cavity wall heating thermal storage wall / Trombe wall	direct solar gain system sunspace	solar attic	energy piles absorber diaphragm wall	thermal mass foundation slab with absorber lines	thermo-acti- vation	thermal mass thermo- activation
	prevention heat loss limitation	adaptable insulation	thermal shutter translucent insulation	adaptable insulation	-	adaptable insulation	-	
 cooling	promotion provide space cooling	earth shelter	-	roof pond	energy piles absorber diaphragm wall	direct contact foundation slab foundation slab with absorber lines earth shelter	thermo-acti- vation	thermo-acti- vation
	prevention overheating prevention		light shelf switchable window system		-	thermal mass	-	structural shading device thermal mass
 ventilation	promotion enforce nat- ural energy flows	solar chim- ney	-	solar chim- ney wind catcher	-	-	-	-
	distribution / recovery precondition ventilation air	dynamic insulation	-			hollow core ventilation	hollow core ventilation	hollow core ventilation
 daylighting	promotion / prevention / distribution control comfortable amounts of daylight	-	light shelf switchable window system translucent insulation	structural shading device	-	-	-	structural shading device

TABLE 5.8 Matrix of climate-responsive building elements.

DESIGN SOLUTION	DESCRIPTION
adaptable insulation	Adaptable insulation is any type of insulation that is able to change its thermal characteristics.
cavity wall heating	A cavity wall is the air-filled space in-between two layers of the building skin or in-between common walls of attached dwellings. When preheated air is blown into the cavity it will heat the adjoining walls which will radiate the heat into the building space after a certain time lag. When using the shared cavity wall of attached dwellings, two houses profit from one system.
switchable window system	Switchable windows are able to change their optical characteristics, e.g. absorptance, reflectance, transmittance or light-scattering. A distinction can be made in active and passive systems. Active systems alter their optical characteristics from user intervention or any automated process. Passive systems are self-regulating and gain different optical characteristics from changes in temperature or light incidence. Other denotations are smart, dynamic, advanced or chromogenic.
direct contact foundation slab	The direct contact foundation slab is specifically designed to be in direct contact with the earth below, so the earth's large storage and exchange capacity can provide basic cooling.
direct solar gain system	In a direct solar gain system the living space functions as the solar collector. The interior building mass is directly heated by incoming solar radiation and captured heat is dispersed to the space.
dynamic insulation	Dynamic insulation exploits the permeability of outer walls. When air transfer through the building skin is allowed, the heat exchange characteristics of the outer wall can be employed to preheat fresh ventilation air. The air flow is either led through specially constructed cavities within the wall or by leading it through a permeable insulation layer. This latter concept is also known as the breathing wall.
energy piles	Energy piles are like ordinary construction piles. Besides providing support to the building structure they also function as a heat exchanger with the earth's large thermal storage capacity.
hollow core ventilation	With hollow core the storage and exchange capacity of massive building layers is used to exchange heat to ventilation air running through the hollow cores of structural elements, mostly floors, before it is ventilated into the space.
light shelf	Light shelves are horizontal overhangs placed above eye-level in a window and divide the window in two horizontal layers. The shelf controls the amount of daylight entering a room by simultaneously delivering shade to (a part of) the room behind and reflecting light towards the ceiling allowing it to penetrate deep into the room.
roof pond	A roof pond is originally designed as an open pool on the roof and functions as a passive cooling system in hot areas where it benefits from the evaporative cooling effect. By covering the roof pond and control the aperture of the pool to the sky the concept can become beneficial in colder climates as well.
solar attic	A solar attic collects solar radiation in the attic space for space heating purposes. It is especially useful in a denser built environment where the lower levels of a building can not be accessed by the winter sun directly. A solar attic needs to be placed outside the thermal envelope of the main building to prevent issues with overheating in summer.
solar chimney	A solar chimney promotes natural ventilation based on the natural stack effect. Solar radiation heats up the air in a chimney, forcing air to move upwards. When the air is able to exhaust from the upper vent, fresh air is drawn into the building from lower placed vents. The solar chimney can be used to remove undesired stale air from the building and drawing fresh air in.
structural shading device	Structural shading devices or overhang elements strategically placed above windows provide shade to the window at certain sun angles. Such structural elements can be a balcony, canopy or cantilevered storey.
sun space	A sun space is an unheated transparent building extension placed outside the thermal envelope of the main building. It collects solar radiation and provides an additional living space.

>>>

DESIGN SOLUTION	DESCRIPTION
thermal mass	Thermal mass is the capacity of a material to store heat, either from direct solar radiation or from passing air flows. As the result of this buffering behaviour indoor temperature swings are smoothed. In addition, energy is stored during the day and released during the night. This will lower the temperature drop during the night and thus the desired amount of heat required for the next day.
thermal shutter	Thermal shutters are insulated shutters that can be placed tightly fitted in front of a window. Thermal shutters provide an additional insulating layer to the window during the night, when it is most needed. It then compensates for the nocturnal radiation through transparent openings that is detrimental to the window's overall thermal energy balance. Not every window shutter is a thermal shutter. Thermal shutters have increased thermal resistance and fit tightly into the window system. The shutters can be placed both on the outside of a window or at the inside.
thermal storage wall / Trombe wall	A thermal storage wall consists of a layer of glass placed in front of a sun-faced wall with a small airspace in between. During daytime the sun warms the air in the cavity and heat is absorbed by the wall. This heat is conducted through the wall and radiated into the space behind. With a Trombe wall the preheated air in the cavity can also be ventilated into the building.
thermo-activation	With thermo-activation the storage and exchange capacity of massive building layers is actively used in the distribution of energy throughout the building. A transport medium, often water, flows through an integrated tube system and activates or deactivates the thermal buffering effect of massive layers.
translucent insulation	Translucent insulation is the umbrella term for all thermal insulation materials that transmit a certain amount of light.
wind catcher	A wind catcher or wind chimney is a chimney that towers above roof level and is able to harvest energy from the more undisturbed wind flows.

TABLE 5.9 Short description of climate-responsive building elements.

In the next chapter more design relevant information is given for each of the climate-responsive building elements. The remainder of this chapter elaborates on some specific characteristics of climate-responsive building elements since they all incorporate some kind of responsive behaviour and all have a certain degree of structural and architectural integration.

§ 5.5 Content requirements for the design support tool

In the next chapter more design relevant information is given for each of the climate-responsive building elements as presented in Table 5.8. This information is then transformed as part of a climate-responsive design support tool to which the layout is given in chapter 7.

The content requirements for the design support tool can be denominated, based on the theoretical framework as presented in chapter 2 and the gathered and generated knowledge in the previous chapters 3 and 4 and in the prior sections of this chapter.

In order to design with climate-responsive building elements the architect should be given an overview of the **comfort contribution and energy performance** of climate-responsive design solutions. Because that is why these elements are potentially beneficial. This information on **performance** aids the architect in selecting those solutions that help achieve the design objectives on comfort and energy.

Furthermore, **the identification of collaborations and conflicts when using multiple design principles together** is essential. The generation of a satisfying design is more than just stacking principles upon each other. In some cases the combination can only become beneficial when certain areas of concern are considered, while in other cases greater convergence of stacking can boost overall performance. In addition, it should be made clear what a **possible energy function of a building element is besides their primary function**. This is where comfort and energy related design objectives of climate-responsive building elements meet other objectives (i.e. spatial, functional and structural). The architect should be made aware of possible adjustments needed when applied as climate-responsive elements in contrary to when used traditionally, i.e. non climate-responsive. Both aspects are relevant to the **process** of design.

Finally, **the impact of climate-responsive building elements on the appearance of design** is relevant. Many climate-responsive building elements will not be visible while others will leave a clear aesthetic trace. The **architectural consequences** of using invisible or visible green elements in design can be part of the architect's strategy.

References

- Asselbergs, M.F., Eekhout, A.C.J.M., Van Kemenade, J., Van Timmeren, A. and Veerman, J. (2010) Concept House Prototype 2010. Delft, The Netherlands: research group Concept House, faculty of Architecture, Delft University of Technology.
- Brand, S. (1994) *How Buildings Learn: What Happens After They're Built*. New York: Viking.
- Brown, G.Z. and DeKay, M. (2001) *Sun, Wind and Light -architectural design strategies* (2nd edition). New York: John Wiley and Sons, Inc.
- Crown (2008) *The Code for Sustainable Homes – setting the standard in sustainability in new homes*. Wetherby, England: Communities and Local Government Publications. <http://www.communities.gov.uk>
- Dunster, B., Simmons, C. and Gilbert, B. (2008) *the ZEDbook -solutions for a shrinking world*. Abingdon: England: Taylor & Francis.
- Hegger, M., Fuchs, M., Stark, T. and Zeumer, M. (2008) *Energy Manual – Sustainable Architecture*. Basel, Switzerland: Birkhäuser.
- Fountain, M., Brager, G. and De Dear, R. (1996) Expectations of indoor climate control in *Energy and Buildings*, vol. 24, issue 3, pp. 179–182.
- Hastings, R.S. (1989) Computer Design Tools for Climate-Responsive Architecture in *Solar and Wind Technology*, vol. 6, issue 4, pp. 357-363.
- IOPscience (2014) *Smart Materials and Structures*. Retrieved from <http://iopscience.iop.org/0964-1726/page/Scope>
- Kristinsson, J. (2002). *Integraal ontwerpen: Vitale architectuur*. Deventer, The Netherlands: KristinsReitsema.
- Kristinsson, J., and Van den Dobbelen, A. (2012) *Integrated sustainable design*. Delft: The Netherlands: Delftdigitalpress.
- Leupen, B.A.J. (2002) *Kader en generieke ruimte: een onderzoek naar de veranderbare woning op basis van het permanente*. Rotterdam, The Netherlands: Uitgeverij 010.
- Leupen, B. and Mooij, H. (2008) *Het ontwerpen van woningen – een handboek*. Rotterdam, The Netherlands: NAI publishers.
- Mahdavi, A. and Kumar, S. (1996) Implications of indoor climate control for comfort, energy and environment in *Energy and Buildings*, vol. 24, issue 3, pp. 167–177.
- Olgay, V. (1963) *Design with Climate – bioclimatic approach to architectural regionalism*. Princeton: Princeton University press.
- Passivhaus Institut (2014) *Passive House requirements*. Retrieved from http://passiv.de/en/02_informations/02_passive-house-requirements/02_passive-house-requirements.htm
- Rau (2009) *Integrale energiekolommen in Utrecht*. Retrieved from <http://www.rau.eu/blog/?p=803>
- Sackmann, R. (1988) *Ontwerpen en bouwmethodiek -Ontwerpen met draagkonstrukties*. Delft, The Netherlands: Delft University Press.
- Santamouris, M. [ed.] (2001) *Energy and Climate in the Urban Built Environment*. London, England: James & James.
- Szokolay, S.V. (2008) *Introduction to Architectural Science -the basis for sustainable design* [second edition]. Oxford, England: Architectural Press.
- Van Marken Lichtenbelt, W.D., Kingma, B.R., Van der Lans, A.J.J., Schellen, L. (2014) Cold exposure – an approach to increasing energy expenditure in humans in *Trends in Endocrinology & Metabolism*, Volume 25, Issue 4, April 2014, Pages 165-167.
- Yeang, K. (1991) *Designing the Green Skyscraper* in *Habitat International*, vol. 15, issue 3, pp. 149-166.
- Yeang, K. (1995) *Designing with Nature -the ecological basis for architectural design*. New York: McGraw-Hill.
- Yeang, K. (2008) *Ecodesign: A Manual for Ecological Design*. New York: John Wiley & Sons Ltd.
- ZEDfactory (2010) *ruralZED – the zero carbon house is ready* (Brochure). Retrieved from <http://www.ruralzed.com>

6 Climate-responsive building elements toolbox

In chapter 5 the foundation of climate-responsive design was studied. This resulted in a list of climate-responsive building elements (Table 5.8). This chapter elaborates on that list by providing additional knowledge on the following aspects: energy performance and comfort contribution, architectural and spatial consequences for application and implications for the architectural design process.

As the discussion will make clear, many design principles and solutions lend themselves for improved overall performance through collaboration. Some of these combined solutions are briefly presented in section 6.9. In the final section of this chapter the findings are collected in a resumé, providing guidelines for the phase of energy concept development.

§ 6.1 Introduction

The climate-responsive building elements are discussed in a logical order in which some of the more general principles, on which other design solutions are partially based, are discussed first. The overview presented here is extensive but has no intention of being exclusive or selective. Some elements would address to more than one principle. They are categorised within the principle according to their primary function (Table 6.1).

DESIGN PRINCIPLES	DESIGN SOLUTIONS
thermal conservation	adaptable insulation thermal shutter translucent insulation dynamic insulation
thermal buffering + thermal distribution	thermal mass thermo-activated building elements cavity wall heating ventilated hollow core elements
passive solar heating	direct solar gain thermal storage wall sun space roof pond [solar attic]
earth-coupling	direct-contact foundation slab earth shelter energy piles
natural illumination	light-redirecting window systems switchable window systems light shelf
natural ventilation	solar chimney wind chimney
solar shading	[structural shading device]

TABLE 6.1 Overview of discussed climate-responsive building elements, grouped according to their primary design principle. Solutions presented between straight brackets are mentioned, but not discussed in great detail.

Each of the considered design principles starts with a concise discussion of relevant design solutions - not only limited to climate-responsive building elements - and is followed by a study on the aspects that were identified as content requirements in section 5.5:

- **Performance**
the comfort contribution and energy performance
- **Process**
the collaborations and conflicts of combining solutions, and the possible energy function of a building element
- **Architectural consequences**
the impact of climate-responsive building elements on the appearance of design

The aspect of performance includes typical characteristics of the design solution and its components and its potential for improving energy performance and comfort contribution. The knowledge is based on state-of-the-art research. The aspect of process enumerates architectural and spatial design considerations concerned with the employment of the design solution in question; identifying possible conflicts with other strategies. Finally, the aspect of architectural consequences deals with materialisation and composition and shows the degree of architectural integration (see chapter 5) and discusses the suitability for renovation projects.

§ 6.2 Thermal conservation

Thermal conservation strategies aim at reducing heat losses both from transmission and infiltration. Such strategies typically include specific notion to insulation and airtightness of the building envelope.

In the building industry insulation capacity of (building) materials is specified using the material's thermal resistance or R-value. Standards for newly built residential buildings in The Netherlands are 4.5 m²K/W for opaque wall elements and 6.0 m²K/W for roofs. Superinsulation is a collective term of a significant improvement of the thermal resistance of the building skin compared to common practice. Since common practice and thus typical R-values link to local context, superinsulation is not so much denoted with fixed numbers. As far as the Netherlands (and similar climates) is concerned superinsulation may imply R-values of 6, 8 or even 10 m²K/W; typical values in a PassiveHouse concept where (super)insulation is commonly employed with the intention to predominantly heat the building from internal heat producing sources.

Improved levels of thermal resistance can be achieved by using thicker layers of insulation, at the expense of building space, or by using advanced insulation materials such as aerogel or vacuum insulation that have an increased intrinsic thermal resistance (Baetens et al., 2010a, 2011).

As an alternative to fixed thermal resistance of the building skin the concept of adaptable insulation (section 6.2.1) enables an adaptable thermal resistance that better fits to variations in energy offer and demand.

Windows are accountable for a large part of the transmission losses in common building design, since they are typically worse insulators than opaque building elements. To limit heat loss through windows without cutting out daylight admission and outside view a thermal shutter (section 6.2.2), which improves the thermal resistance of the window system, can be placed in front of the window during the night. If windows are just to guarantee daylight admittance they can also be replaced with translucent insulation (section 6.2.3), which gives improved thermal resistance and still allows for diffuse light to enter.

Infiltration is the uncontrolled air flow through cracks and openings in the building envelope. While they provide part of the ventilation needs they are considered undesired because of their uncontrolled nature. When special attention is paid to the realisation of an air-tight envelope during construction infiltration air flows can be reduced to a minimum. However, reducing infiltration losses is concurrent to paying more attention to proper ventilation measures to assure a healthy indoor air quality. Alternatively heat loss from infiltration air flow through the building envelope can be partly reclaimed by allowing it to preheat incoming fresh air flows following the concept of dynamic insulation (section 6.2.4).

Other strategies for thermal conservation focus on spatial aspects. Such strategies include compact building design and thermal zoning. The compactness of dwelling is the ratio between the exposed surface area and the building volume. Typically, more exposed surface area at a given volume will indicate a greater heat loss and thus a reduced energy performance. To further minimise exposed surface area dwellings can be connected and stacked. The benefits of compact design on thermal performance are evident but may be in conflict with other passive strategies. So are natural ventilation strategies best served with spread-out layouts and large building blocks may benefit from a stretched plan for proper daylight admission. With respect to the latter an atrium might be a design solution that compromises both compact design and sufficient daylight admittance.

With thermal zoning the different zones in a building can be arranged according to their thermal requirements. For instance, zones that require more heat and daylight can be placed towards the sun. Another option is to surround zones with the more stringent heat requirements with buffer zones that have less stringent requirements.

§ 6.2.1 Adaptable insulation

Adaptable insulation is any type of insulation that is able to change its thermal resistance from an insulated state to a conductive state. By doing so the thermal resistance of the building envelope can be altered to be more in tune with changing requirements based on dynamic weather conditions and occupation. Adaptable insulation has yet not been developed into commercial products specific for the building industry. Practical building solutions, though only as prototype, are formed by switchable thermal insulation panels (STI). Another type of adaptable insulation could be formed by using gas-filled panels (GFP).

Switchable thermal insulation (STI) panels are practically similar to commercial available vacuum insulation panels that consist of an evacuated core material encased by airtight container or envelope (Baetens et al., 2010a). The evacuated state, and thus a high thermal resistance, is maintained by an entrapped getter that absorbs the hydrogen within the panel. By heating the getter the absorbed hydrogen is released and the panel's thermal resistance decreases. Another type of adaptable insulation could be formed by using gas-filled panels (GFP). GFPs are in essence sealed bags containing a certain amount of chambers constructed from plastic sheets and aluminised thin foils joined together in a honeycomb structure (Baetens et al., 2010c). The GFP can be inflated or deflated through a nozzle. When deflated the panels have limited thickness and thermal resistance. When inflated the panels gain a high thermal resistance.

Both types of adaptable insulation require a control system for controlling the adaptable behaviour. With the STI this system is minimal since only an electrical current is needed to be applied to the getter inside the panel. The hermetically sealed GFPs need an additional system that inflates and deflates the panel. Fairly simple compressors can be used when the GFP is filled with air. When other gases than air are used a more elaborate system including a storage vessel is needed. Both types of insulation, but GFP in particular, require regular maintenance after installation. Therefore easy accessibility of the insulation panels is preferable.

Performance

Practical thermal conductivity of switchable thermal insulation (STI) using glass fibre board varies between 0.003 W/mK and 0.15 W/mK for a 2 cm thick panel, where a continuous electrical current of roughly 5 W/m² is needed to maintain the high conductance state (Meister et al., 1999). With gas-filled panels (GFP) best performance values for the thermal resistance of a 50 mm thick panel varies from 1.8 m²K/W to 4.2 m²K/W depending on the gas used to fill the chambers (see Table 6.2). The thermal resistance is minimal when the GFP is deflated, due to its limited thickness.

GAS	Λ_{EFF} (W/MK)	R-VALUE (M ² K/W)
air	0.028	1.8
argon	0.020	2.5
krypton	0.012	4.2

TABLE 6.2 Typical thermal resistance of gas-filled (GFP) with thickness of 50 mm for different gas fills (Baetens et al., 2010c).

Since the GFPs can be inflated and deflated on demand, in theory, a switchable set-up for use in buildings could be realised. The gas-fill is then applied to tune dynamic climate conditions with indoor thermal requirements. Gas-filled panels with built in nozzles are available on the market. Such commercial products exist mainly for high-demanding cargo and storage purposes (Coldpack, 2011; GFP insulation, 2011; Lawrence Berkeley National Laboratory, 2011). When deflated such GFPs have a very small thickness of 0.4 mm (Fi-Foil, 2011) and limited heat resistance when compared to conventional thermal insulation in the building industry. However, no such product or prototype has been developed specifically for the building industry yet.

The comfort and energy performance of a standard office room equipped with adaptable insulation using GFPs, located in a Dutch climate, was researched by Van der Spoel et al. (2008). In their dynamic numerical study they assumed thermal resistances of 3.0 m²K/W in the insulated state and a thermal resistance of 0.17 m²K/W in the conductive state. The switch between insulated and conductive state

is triggered by the indoor temperature and the direction of the thermal gradient. The use of adaptable insulation in favour of common insulation does not appear to be beneficial in a passive solar heating strategy for office spaces but does show a positive effect when used in a passive cooling strategy.¹⁸

Process

The use of adaptable insulation can be an alternative to night-time ventilation for habitable zones (e.g. bedrooms) to prevent issues of draught. The adaptable insulation is in a resistive state except during the cooler nights in hot summer periods to flush excessive heat from the building.

Architectural consequences

The STI has a rigid shape and is easily embedded into typical building structures. A GFP lacks stiffness by itself but can easily replace traditional insulation layers in stud walls. Alternatively, Van der Spoel et al. (2008) showed that GFPs can also be used as an aesthetical feature when the GFP changes shape when its changes state from inflated to deflated, or vice versa. However, since GFPs are vulnerable to defects they require some kind of protective shield whereas the steel encasing of STI makes it less vulnerable.

§ 6.2.2 Thermal shutter

A thermal shutter is an insulated shutter that can be placed in front of a window. Thermal shutters provide an additional insulating layer to the window during the night in the heating season, when it is most needed. It then compensates for the nocturnal radiation through transparent openings that is detrimental to the window's overall thermal energy balance. Not every window shutter is a thermal shutter. Thermal shutters have increased thermal resistance and fit tightly into the window system.

18

Conditions for optimum effect are the use of a non-insulating thermal storage layer on the inside of the construction and ambient air as a heat sink (i.e. adaptable insulation will not function properly when applied in ground floor slabs). The study findings show a reduction of the exceeding hours with a factor 7. Furthermore, a free cooling equivalent of 60 to 80 MJ/m² per annum is achievable with adaptable insulation installed in the façade or roof after optimisation of the control strategy.

Performance

Table 6.3 shows the results of a small parameter analysis of thermal shutters applied to a typical mid-terraced dwelling in the Netherlands. The analysis is conducted by the author. More information on the building model and other simulation parameters can be found in Appendix A.

	SIMULATION #01	SIMULATION #02	SIMULATION #03	SIMULATION #04
shutter location	on all windows on the inside	on all windows on the inside	on all windows on the inside	on all windows on the inside
shutter control	closed when solar radiation is 0	closed when solar radiation is 0	closed when solar radiation is 0	closed between 23:00 – 07:00 hours
heat resistance of shutter	1.6 m ² K/W	3.2 m ² K/W	6.4 m ² K/W	3.2 m ² K/W
reduction of heat demand	13.6%	15.6%	16.9%	9.1%
reduction of transmission losses	14.9%	17.1%	18.6%	11.5%

TABLE 6.3 Influence of thermal shutters on heat demand and transmission losses of a typical Dutch mid-terraced dwelling. Considered parameters are the heat resistance of the thermal shutter and the control strategy for putting the shutters in place.

When the shutters are closed at sunset, the additional heat resistance of the shutter makes that the overall heat resistance of the window and shutter together is equal to the heat resistance of the opaque façade elements (SIMULATION #01), the annual heat demand is reduced with 15.6% and the transmission losses drop with 17.1%. The variation in the heat resistance of the shutters (SIMULATION #02 and SIMULATION #03) does affect overall performance, as expected. However, the differences are small. The shutter control strategy is an important factor. When the shutters are not closed when the sun sets but only during sleeping hours (SIMULATION #04) the performance drops significantly. The heat demand then only reduces with 9.1%.

Process

The overall performance can be increased when the shutters are placed in front of the window when the energy balance of the window has become negative (i.e. transmission losses are larger than solar gains). However, this will imply that shutters can be closed during the day at times when it is very cloudy or very cold. This may interfere with visual comfort demands.

Architectural consequences

Thermal shutters can be placed both on the inside or on the outside of a window and have different variations in operability (Figure 6.1). Shutters placed on the outside of the window are visually present and can be designed as an architectural feature (Figure 6.2, Figure 6.3).

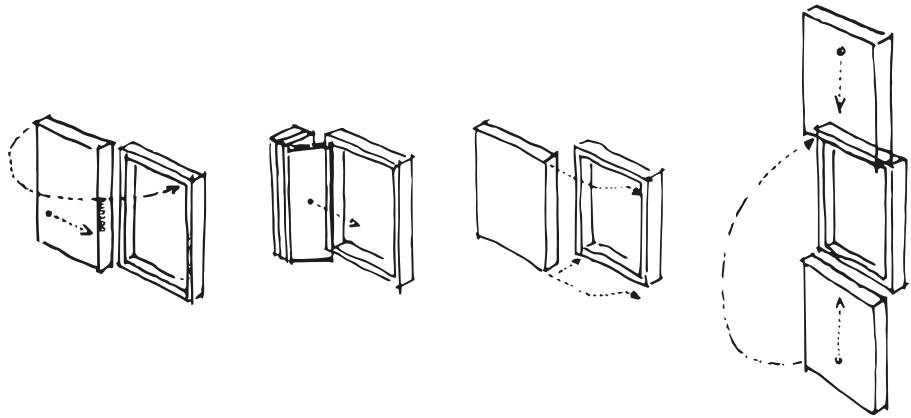

FIGURE 6.1 Different variations in the operability of thermal shutters. Adapted from Kristinsson & Van den Dobbelsteen (2012).



FIGURE 6.2 External hinged thermal shutters. Minimum-energy dwellings, Schiedam, the Netherlands by Jón Kristinsson. Photo by Jón Kristinsson.



FIGURE 6.3 External folded thermal shutters. Search office building, Amsterdam, the Netherlands by Witteveen architects. Photo by Jeroen Musch.

§ 6.2.3 Translucent insulation

Translucent insulation (TI) is the collective term for thermal insulation materials with a high solar transmittance. TI transforms direct beam radiation into diffuse light. The admitted diffuse light is then scattered more evenly throughout the room and the absence of direct radiation eliminates issues of glare. As a consequence, translucent insulation obscures the view out.

Typical translucent insulation materials (TIM) are composed of porous array structured materials such as glass fibre tissue or thermoplastics. The heat resistance of translucent insulation as a system (e.g. placed within a glazing system) is derived from enclosed air gaps or evacuated spaces (Kaushika & Sumathy, 2003; Wong et al., 2007). More recently renewed attention is given to advanced insulation materials with similar characteristics such as aerogels, i.e. dried gels with a very high porosity (Baetens et al., 2011).¹⁹

Performance

Table 6.4 shows the U-value and the solar and light transmittance of different translucent insulation systems, compared to some high performance window systems. Some translucent insulation materials (TIM) have lower thermal conductivities than high performance insulated glazing but allow more heat from natural light to enter the building.

19

Some aerogel materials still allow views through and are technically not a TIM. Still they are considered here as well while, compared to clear glazing, the view through such aerogel glazing units is obscured by a haze and it scatters the incoming light when exposed to direct sunlight.

GLAZING TYPE	U_{glass} (W/m ² K)	T_{sol}	T_{vis}
translucent insulation systems using thermoplastics			
Okapane glazing unit with 40 mm of glass fibre tissue in a 56 mm cavity (Okalux, 2011)	1.1 - 1.4	38%	38%
Kalwall system with fibreglass insulation; thickness of 100 mm (Kalwall, 2010)	0.45 - 0.85	4 - 9%	5 - 12%
translucent insulation systems using aerogels			
Prototype glazing unit with 15 mm monolithic silica aerogel (Jensen et al., 2004)	≤ 0.7	76%	
Kalwall system with aerogel infill; thickness of 70 mm (Kalwall, 2010)	0.3	12 - 22%	12 - 20%
Okagel glazing unit with 60 mm of Okagel (Okalux, 2011)	0.3	≤ 61%	≤ 59%
high performance window systems			
High performance double-pane glazing with low-emissivity coating and argon fill; total thickness of 24 mm (Saint Gobain, 2010)	1.2	64%	80%
Triple glazing with argon fill; total thickness of 30 or 36 mm (Saint Gobain, 2010)	0.7 - 0.9	50%	71%

TABLE 6.4 Typical properties of translucent insulation systems compared to high performance window systems.

Process

The application of TIM integrates the aspects of thermal insulation, natural illumination and privacy and glare control in a single architectural solution and may therefore be favoured over other design solutions that combine multiple measures to achieve the same result.

Architectural consequences

The effect of light scattering due to its translucency makes TI an interesting architectural element from an aesthetical point of view (Figure 6.4). To prevent possible issues with hindrance from scattered light, TI is best used at intermittently used spaces or at that side of the building that receives little direct solar radiation (e.g. north side of the building in the Northern Hemisphere).



FIGURE 6.4 Translucent insulation used in the façade of the staircase of a private dwelling in Filothei, Athens, Greece by GEM architects. Reprinted from Helmania website.

§ 6.2.4 Dynamic insulation

Dynamic insulation is an air-permeable insulation layer in an external wall or roof structure through which air from outside is led. The air is pre-heated by the conductive heat flow in the opposite direction. Dynamic insulation exploits the permeability of outer walls in order to reduce heat losses, in contrast to air-tight buildings. When air transfer through the building skin is allowed, the heat exchange characteristics of the outer wall can be employed to preheat fresh ventilation air, and thereby reducing the conductive heat loss through the outer wall to very low levels. The air flow is either led through specially constructed cavities within the wall or by leading it through a permeable insulation layer. This latter concept is also known as the breathing wall and is the more common used technique (Aschehoug & Perino, 2009).

Performance

The U-value of dynamic insulation depends on the air flow rate through the insulation layer. At increased air flows the conductive heat losses will drop which results in a lower overall U-value of the insulated layer when compared to the static situation (e.g. no convective flows in the insulation layer) (Figure 6.5). Experiments performed within a test cell chamber as shown in Figure 6.8 show that at an infiltration rate of 40 m³/h (equivalent to an air exchange rate of one per hour for the test setup) the U-value of the whole wall structure is 0.1 W/m²K, compared to 0.26 W/m²K in the static situation (Baker, 2003). At the same time the air flowing through the insulation is pre-heated while it collects heat from the conductive counter-flow. Figure 6.7 shows the (estimated) temperature development of the incoming air. The temperature drops at increased air velocities but the heat recovery is still significant.

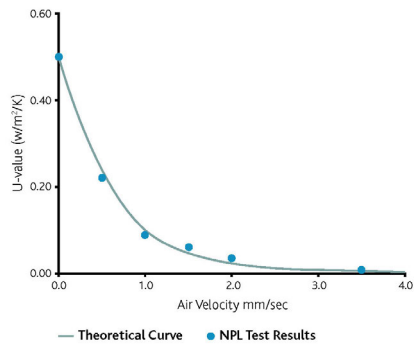

FIGURE 6.5 Dynamic U-value of a 140 mm thick dynamic insulation panel in an EPS encasing. At increased air flow rates through the panel U-value will be lower since conductive heat losses drop significantly. Reprinted from Energyflo (2011).



FIGURE 6.6 Modular dynamic insulation panels mounted in unfinished wall and roof structure. Reprinted from Energyflo Construction Technologies website.

Process

To maintain an inward air flow the indoor air pressure needs to be lower than the outdoor air pressure. A reliable way to maintain an under-pressure is by using vents. However, using the potential of natural forces such as the thermal stack effect and wind forces are preferable from an energy-saving point of view.

Architectural consequences

The dynamic insulation layer can be composed of compressed straw board, mineral wool and thin paperboard or cellulose fibre. For ease of installation commercial products are often encased in EPS or other rigid insulation materials (Figure 6.6). Figure 6.8 shows a typical wall configuration with dynamic insulation, here used in test cell experiments in the UK (Baker, 2003). The dynamic insulation is embedded in a timber framework and covered by a weather-proof cladding at the outside and by plasterboard on the inside, a typical interior surface finish. While plasterboard is impermeable to air the air is withdrawn from the cavity behind the plasterboard and vented into the building.

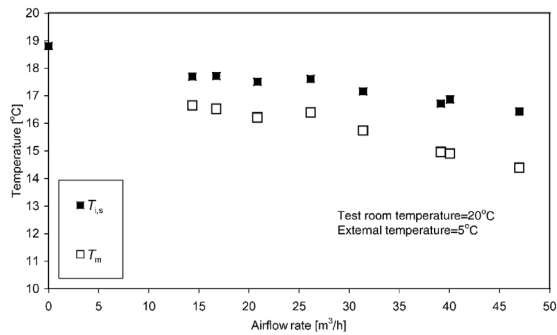

FIGURE 6.7 Estimated interior surface temperature ($T_{i,s}$) and air supply temperature (T_m) at an indoor temperature of 20°C and outdoor temperature of 5°C when using plasterboard as internal cladding. The air temperature decreases with increased air velocity. In theory $T_{i,s} = T_m$ when the air penetrating the dynamic insulation layer is directly introduced into the room. Here $T_m < T_{i,s}$ because of the air impermeable plasterboard layer. Reprinted from Baker (2003).

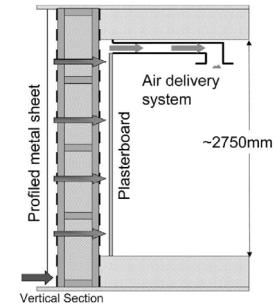

FIGURE 6.8 Test cell wall configuration using dynamic insulation panels. The air is led into the outer cavity wall from an opening at the bottom of the wall. The air then flows slowly through the dynamic insulation. Because of the air impermeable plasterboard layer at the inside, the air is withdrawn from the cavity behind it and distributed into the room using vents. Reprinted from Baker (2003).

§ 6.3 Thermal buffering and thermal distribution

Thermal buffering and distribution using structural and architectural elements is strongly connected. Therefore both concepts are discussed together in this section.

Thermal buffering is the capacity of the building to lessen the impact of fluctuations in the thermal environment. This can be realised by enabling the building's thermal mass (section 6.3.1), the capacity of (building) materials to store and release heat. The basic principle of thermal mass is based on passive means (e.g. follows natural energy flows) and is commonly available in the form of building elements and furniture. A larger share of thermal mass can also be employed in a more controlled way through activation. These so-called thermo-activated building elements (TABS, section 6.3.2) are structural elements through which a transport medium runs that activates or deactivates the thermal mass.

Thermal mass, both passive and through activation, can be employed in two different ways. The first method is to retain surplus heat during the day in colder periods in order to heat the building during the night. A second method is to store excessive heat in the mass during hot days to prevent issues with overheating. The stored heat then needs to be flushed away or discharged from the building to prepare the mass for a next hot day.

Thermal energy can also be distributed throughout the building to provide places that are too cool with abundant heat from somewhere else, or vice versa. Rather than using coupling air flows between one zone to another or adding a separate layer of supporting infrastructure to distribute the heat, the concept of thermal distribution can also be connected to the building's structural layers in order to actively employ the building's thermal mass, as for example with the before mentioned thermo-activated building elements.

Related design solutions are cavity wall heating (section 6.3.3) and ventilated hollow core elements (section 6.3.4), both operating by transporting air using existing cavities. With cavity wall heating warm air is introduced into a cavity wall that will activate the thermal mass of the wall structure upon which heat is eventually radiated into the room. With ventilated hollow core elements the concept of thermal buffering is extended for ventilation purposes. Ventilation air is preconditioned by the energy stored in structural elements before it is introduced into the room.

§ 6.3.1 Thermal mass

Thermal mass is the capacity of a material to store and release heat under the influence of changes in their thermal environment. By doing so it smoothens and delays (indoor) temperature swings. There are two types of thermal mass: external and internal. External thermal mass tempers the effect of outdoor temperature swings and solar radiation exposure of the (opaque) envelope on the indoor temperature. The whole structure contributes to the tempering effect. Internal thermal mass tempers the effect of swings in the indoor temperature resulting from internal heat production or incoming solar radiation. Only a thin layer of mass directly exposed to the indoor environment contributes to that effect.

Performance

The thermal resistance and thermal capacitance of a material determines its tempering effect, in terms of the time lag of peak temperature and its attenuation (Figure 6.9).

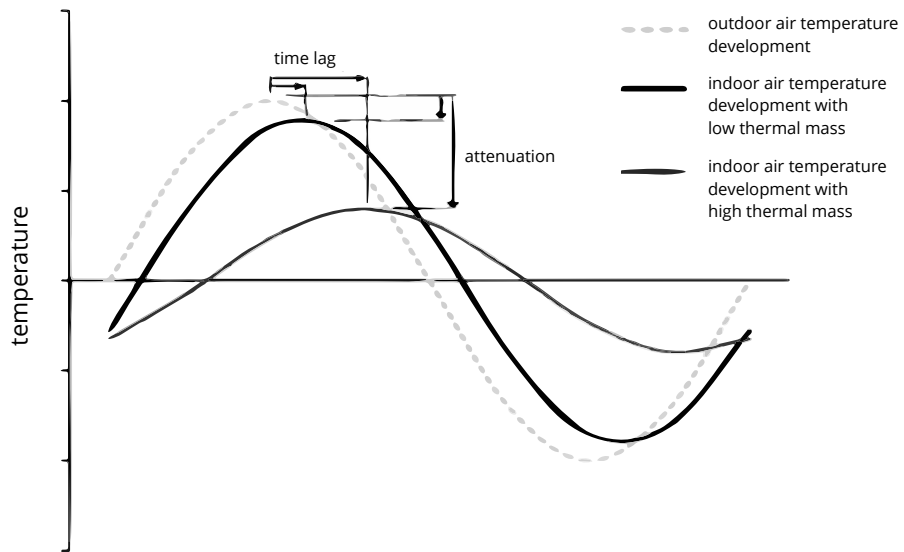

FIGURE 6.9 Typical indoor air temperature development in unconditioned buildings with low thermal mass and in buildings with high thermal mass under the influence of a sinusoidal changing thermal environment; here an ambient temperature trend. High thermal mass will result in a larger time lag and considerable attenuation between outdoor and indoor temperature development.

The amount of energy that can be stored in a material is indicated by its volumetric heat capacity, the product of the material's density and its specific heat capacity. The absorbed heat is eventually released. The time between absorption and re-radiation depends on the material's thermal diffusivity, which equals thermal conductivity divided by the volumetric heat capacity. A low thermal diffusivity indicates a long lag between absorption and re-radiation. This lagging behaviour can become beneficial when stored heat during day time is not directly needed for space heating but rather for preventing large temperature drops overnight.

The volumetric heat capacity and thermal diffusivity of different (building) materials are shown in [Table 6.5](#). The table also shows the properties of non-structural materials such as water and phase change materials (PCM) that form an alternative in certain thermal mass strategies.

MATERIAL	Density ρ (kg/m ³)	Specific heat capacity c_p (J/kgK)	Volumetric heat capacity $(\rho * c_p)$ (J/m ³ K)	(Latent) Heat of fusion (J/kg)	Heat conduc- tivity (W/mK)	Thermal diffusivity $(\lambda / (\rho * c_p))$ (m ² /s)
Structural materials						
Brick	1900	840	1,60E+06	-	0,9	5,64E-07
Heavyweight concrete	2300	840	1,93E+06	-	1,83	9,47E-07
Lightweight concrete	1900	840	1,60E+06	-	1,28	8,02E-07
Structural wood (European pinewood)	550	1880	1,03E+06	-	0,13	1,26E-07
Non-structural materials						
Water	998	4180	4,17E+06	3,34E+05	0,60	-
PCM						
organic (e.g. paraffin)	870	2300	1,87E+06	1,80E+05	0,19	-
inorganic (e.g. salt hydrates)	1475	2700	3,87E+06	1,80E+05	0,56	-
The value for each property of PCM (split into organic and inorganic) is derived from the average value with a melting temperature between 20°C and 30°C.						

TABLE 6.5 Comparison of heat storage capacity of building materials. The volumetric heat capacity determines the amount of energy that can be stored. The thermal diffusivity determines the speed of activation. With substances such as water and PCM the heat of fusion gives an indication of the amount of energy stored or released when the material goes through a phase change from solid to liquid or vice versa (Israëls & Stofberg, 2010; Van der Linden, 2006; Verkerk, 1992; Young et al., 2013)

Due to their high density typical structural materials such as brick and concrete show good heat storage abilities. Organic construction materials such as wood have lower densities but higher specific heat capacity which still make them suitable for use in (passive) thermal mass strategies. Its high specific heat capacity gives water great potential for heat storage. Moreover, due to occurring convection flows heat is transported much quicker throughout the body of water than in massive materials. This results in a much quicker activation of all storage capacity.

Phase change material (PCM) is another, non-structural building material, with high heat storage capacity (Baetens et al., 2010b). PCMs are latent heat storage (LHS) materials that store and release heat when going through a phase change; under atmospheric conditions typically from solid to liquid and vice versa. The (latent) heat of fusion indicates the amount of energy that can be stored or released within a complete phase transition that occurs at a certain melting point or in a certain temperature range. This means that the storage ability of PCM only starts to work at a selective temperature that triggers the phase transition. This effect is quite similar to that of freezing water. However, with a melting point of 0°C the phase transition of water occurs far from comfortable temperatures. Many PCM have a melting point that is well within the comfortable temperature range of 20 to 26°C. Compared to brick and concrete they have increased storage capacities at much lower densities (Table 6.5).

PCM are either encapsulated to form stand-alone elements (Figure 6.10) or processed as additives in other building elements or interior finish. Experimental tests, supported by numerical results, shows that a 5 cm gypsum layer with embedded PCM²⁰ is able to store up to 290 Wh/m² per day (Koschenz & Lehmann, 2004).



FIGURE 6.10 Sliced PCM filled aluminium sheet container. Photo by Bas Hasselaar.

Process

As said before, in order to allow thermal mass to exchange energy with its environment both should be well connected without too many barriers. This puts some constraints on the finish of walls, floor and ceilings which in turn can interfere with commonly taken acoustical measures. Thermal mass composition can be chosen in such a way that a desired lag and attenuation is obtained. For example in homogeneous elements more thickness or a higher thermal capacitance will elongate the lag but will also lead to more attenuation. Alternatively, a well-chosen composition of capacitive and resistive layers will result in a certain time lag but with less attenuation than would be realised in a (much thicker) homogeneous wall (Duffin & Knowles, 1984; Szokolay, 2008).

For illustration purposes, Table 6.6 shows the dynamic thermal properties, according to NEN-EN-ISO 13786 (NEN, 2008), of typical heavy-weight and wood frame external wall compositions. The heavy-weight construction has an internal surface admittance of 4.5 times bigger than the wood frame construction. Together with the large heat capacity the time lag of the heavy-weight structure is 3.3 hours longer and the peak is reduced by a factor 2 with respect to the wood frame structure.

WALL COMPOSITION	thickness (m)	density (kg/m ³)	thermal conductivity (W/mK)	specific heat capacity (J/kgK)	thermal resistance (m ² K/W)
#01: heavy-weight construction with internal and external leafs of bricks					
internal	-	-	-	-	0.13
sand-lime brick	0.10	2000	1.00	840	0.10
insulation	0.15	30	43.00	1470	3.49
cavity	0.04	-	-	-	0.18
building brick	0.10	1900	1.20	840	0.08
external	-	-	-	-	0.04
					4.02
#02: wood frame construction with external leaf of bricks					
internal	-	-	-	-	0.13
wooden panel	13.00	640	0.15	1900	0.08
insulation	0.15	30	43.00	1470	3.49
wooden panel	9.00	640	0.15	1900	0.06
cavity	0.04	-	-	-	0.18
building brick	0.10	1900	1.20	840	0.08
external	-	-	-	-	0.04
					4.06
DYNAMIC THERMAL PROPERTIES					
	thermal admittance (W/m ² K)	thermal transmittance (W/m ² K)	time lag (hr)	areal heat capacity (kJ/m ² K)	decrement factor (-)
#01: heavy-weight construction with internal and external leafs of bricks					
internal surface	5.4	-	1.8	75.2	-
external surface	9.0	-	3.4	124.3	-
periodic	-	0.09	-9.2	-	0.35
#02: wood frame construction with external cladding of brickwork					
internal surface	1.2	-	4.1	19.0	-
external surface	9.1	-	3.3	126.9	-
periodic	-	0.17	-5.9	-	0.70

TABLE 6.6 Dynamic thermal properties, according to NEN-EN-ISO 13786 (NEN, 2008), of a heavy-weight and wood frame wall composition under the influence of a sinusoidal temperature variation with a 24h period. The air-to-air heat resistance of both structures is similar (upper part of the table), but the dynamic properties (bottom part of the table) differ significantly. The heavy-weight structure has an attenuation almost twice as big as produced by the wood frame structure.

In practice, this illustrated dynamic behaviour is heavily affected by ventilation and infiltration air flows since they entail relatively quick and large fluctuations in a thermal environment. Therefore, such air flows should be controlled (e.g. limited to minimal desired to maintain indoor air quality) when thermal mass is to be activated (e.g. storing heat) and needed for heating purposes. However, excessive ventilation is very useful when the mass is employed to prevent issues of overheating and the stored heat needs to be drained from the building (Artmann et al., 2008).

Architectural consequences

The architectural impact of thermal mass is rather low since thermal mass exploits the storage behaviour of common building materials. However, in order to improve its ability to exchange energy with its surroundings, the thermal mass should be well exposed to the environment. This puts restrictions on wall and floor finish and thus may result in structural layers to come into sight (Figure 6.11).



FIGURE 6.11 Thermal mass wall made of loam in AEE INTEC office building, Gleisdorf, Austria.

An advantage of water-based thermal mass systems over massive structural elements is that the system is more easily expandable (i.e. the heat capacity can be adjusted) and collected heat is transportable (i.e. it can be stored elsewhere for later use or distributed to other zones). Water drums can be kept visible to put an emphasis on its presence or can be tucked away within a wall system. This 'mobile' thermal mass system can also be put to use in renovation projects, for instance to replace low-weight interior walls.

§ 6.3.2 Thermo-activated building elements

With thermo active building systems (TABS) a transport medium flows through the core of the (structural) building elements which activates or charges the thermal buffering effect of the massive layer. Through thermo-activation of building elements more thermal mass can be put to use in a more controlled way compared to regular (passive) thermal mass.

In thermo-activated elements the tubes are placed in the core of the structural floor and exchange energy with that concrete layer and thus only indirectly, and delayed, with the adjoining spaces. The same system can also be employed to deactivate or discharge the thermal mass by removing excessive heat stored in the building mass, and thus provide cooling.

The most common configurations use water flowing through an embedded tube system within structural concrete layers, also known as concrete core activation (CCA). Other systems are air-based or ventilated systems that use existing cavities within the building element and, although less common, combined water-based and ventilated systems (Weitzmann, 2004). Even though most common in practice, the concept of thermo-activation is not limited to floor elements. The concept of thermo-activated floors differs from that of ordinary floor heating systems. The difference lies in the position of the embedded tubes and the resulting heat flows (Figure 6.12). The tubes in floor heating systems are positioned in the upper part of the floor area on top of an insulation layer and only warm the space above the floor with a response time that is shorter than with thermo-activated systems.

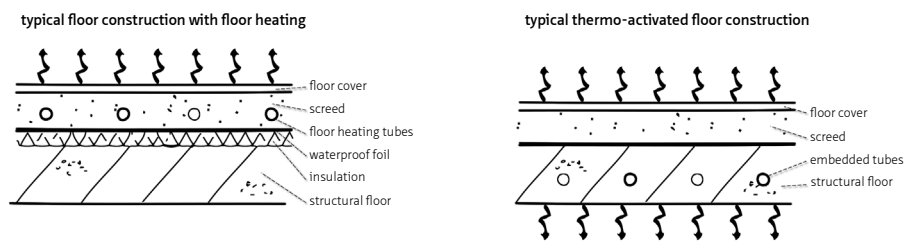

FIGURE 6.12 Typical floor construction with floor heating (left) and typical thermo-activated floor element (right). Adapted from Babiak et al. (2007b).

Performance

Thermo-activated building elements are most commonly used in office buildings that often focus more on cooling due to their intermittent usage and high internal heat loads during occupancy hours. However, post-occupancy monitoring of a dwelling equipped with thermo-activated floor elements (Kalkman, 2007) shows satisfying results for residential use as well.

The monitoring took place in a three-storey dwelling provided with thermo-activation of the ground floor and both storey floors; all equipped with a non-insulated floor cover. Monitoring results showed stable indoor temperatures of 22.0°C +/- 0.9°C for the living room during mid-season where day temperatures are relatively high and night temperatures can drop significantly.²¹ The analysis also showed that comfort could be guaranteed during persistent hot weather (28°C during the day, 20°C at night) where the indoor temperatures did not exceed 24°C.

Process

The large effective surface of thermo-activated building elements allows them to function properly at relative low temperatures, where flow medium temperatures are slightly higher or lower than the desired comfort temperature. Therefore, thermo-activation is most effectively combined in a system that harvests low temperature heat sources such as ambient heat, regained waste heat or ground-coupling. The system has a relative long response-time and will fail to provide comfort when the building suffers quick and large temperature changes. Proper design measures with respect to solar screening and adequate thermal insulation are therefore necessary.

It is important that floor and ceiling cover are geared to the use of thermo-activated floor elements. Too much thermal resistance will obstruct heat exchange between floor structure and the adjoining space (Kalkman, 2005²²; Lehmann et al., 2007; Weitzmann, 2004). Otherwise the thermo-activated building elements will become thermally stable at the expense of the adjoining spaces. However, leaving the structural layer bare requires specific attention to prevent acoustical discomfort since typical measures can become counterproductive to the thermal buffering effect (see

-
- 21 Occasional peaks in the indoor temperature are found in the late afternoon and during the night. These peaks were explained from the counterproductive energy balance of the large unshaded windows; too much solar radiation harvest during the day and too much transmission heat loss during the night. The use of proper shading and the application of better insulating glazing systems or thermal shutters could reduce these effects.
- 22 Similar findings on the avoidance of insulated layers were obtained in this detailed study to best practice configuration of thermo-activated floor elements in combination with a heat pump connected to energy piles in a single-family dwelling in Kampen, the Netherlands.

thermal mass, section 6.3.1). This especially goes for storey floors in stacked dwellings but can be solved by the selection of materials that contribute to both the desired thermal and acoustical aspects or by applying additional acoustical measures to the room.

The application of thermo-activation requires careful planning during the construction phase in order to avoid processing the thermo-activated building elements afterwards that could damage the embedded piping (e.g. drilling and milling work for electrical wiring).

Architectural consequences

Similar to thermal mass, the architectural impact of thermo-activated building systems is minimal since the concept exploits the storage behaviour of common structural elements. Nevertheless, the thermo-activated elements should be well exposed to their environment in order to employ its ability to exchange energy. This puts restrictions on wall and floor finish and thus may result in structural layers to come into sight (Babiak et al., 2007a).

The high level of integration makes this concept best fit for new housing developments. However, a similar concept to that of thermo-activated building elements is a system with capillary micro pipes that can be embedded in a gypsum layer (Babiak et al., 2007b; Koschenz & Lehmann, 2004). Although this concept activates less of the available thermal mass, it can still be beneficial in renovation projects.

§ 6.3.3 Cavity wall heating

A cavity wall is the whole setup of two wall layers with an air-filled space in-between. When warm air is blown into the cavity it will heat the wall structure which will eventually radiate heat into the building. When using the cavity wall of a common wall between two adjoining houses, both houses profit from one and the same system.

The preheated air can be generated and transported to the cavity in different ways. A proven concept is that of the solar cavity wall where solar radiation warms the air in either a roof collector or a sunspace (see section 6.4.3). In both cases the warm air is withdrawn from the collector using a fan and then introduced to the cavity wall. In the first setup (Figure 6.13) air is warmed by solar radiation in the roof collector that covers the whole sloped surface facing the sun. The warm air from the ridge is then drawn down one side of the dwelling, spread throughout the crawl space, flows upwards in the cavity wall on the other side of the dwelling and is finally led into the

roof collector again for another warming cycle. In the second setup (Figure 6.14) air is warmed in the sunspace, which can be used as an additional living space. The warmed air is withdrawn from the sunspace and transported to the cavity of the common wall between two dwellings. The air is forced to flow downwards and then upwards in the cavity wall and is eventually ventilated back into the sunspace.

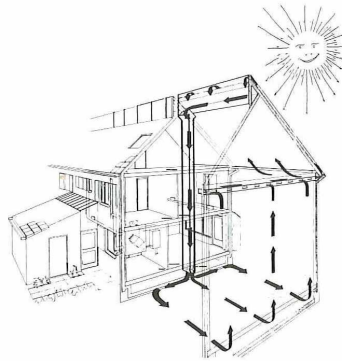

FIGURE 6.13 Solar cavity wall concept with a roof collector. Solar cavity wall dwellings, Hoofddorp (1984) by architect Jón Kristinsson. Reprinted from Kristinsson (2002).

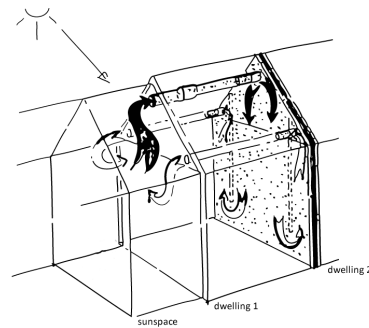

FIGURE 6.14 Solar cavity wall concept with sunspace collector. Solar cavity dwellings, Morra Park, Drachten (1990) by Jón Kristinsson. Reprinted from Kristinsson & Van den Dobbelsteen (2012).

Performance

Practical implementation of the solar cavity wall concept revealed the potential of the system in mid-season with relatively high temperature difference between day and night (Kristinsson & Van den Dobbelsteen, 2012; Van den Ent et al., 1982). During the darkest days of the winter an auxiliary heating system is needed to maintain comfortable indoor temperatures. Post-occupancy evaluation showed an auxiliary space heating demand of 500 m³ gas/year for the solar cavity wall dwellings in Morra Park, Drachten. The solar cavity wall with a roof collector was found to be more effective. The dwellings only need approximately 100 m³ gas/year for additional space heating. In comparison, the calculated annual gas demand for space heating for typical newly built dwellings at that time dropped from 1571 m³ in 1983, to 1054 m³ in 1988 to 920 m³ in 1990 (Figure 3.4). Both project examples were equipped with a balanced ventilation system with heat recovery unit, which limits heating demand in colder periods.

Architectural consequences

When using a roof collector the visibility of a solar cavity wall system is limited. The sunspace on the other hand is more noticeable and could be seen as an architectural design feature and adds more living space.

Implementing cavity wall heating using roof collectors in renovation projects is possible but may require significant architectural intervention. Moreover, the application is bounded by some criteria surrounding the usability of the cavity wall structure and the crawl space.

§ 6.3.4 Ventilated hollow core elements

In ventilated hollow core elements the storage and exchange capacity of the massive building layer is used to exchange heat to air circulating through the hollow cores of structural elements (Figure 6.15), mostly concrete floors (Weitzman, 2004; Winwood et al., 1997). The presence of hollow cores in structural floor elements is common in the building industry from a cost-reduction point of view because it reduces the weight of the element while maintaining similar dimensions and strength.

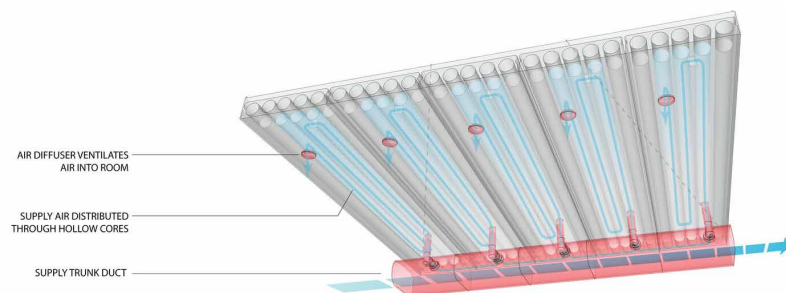

FIGURE 6.15 Ventilated hollow core floor element in which ventilation air running through the cores is preconditioned from stored in the mass of the floor. Reprinted from <http://www.termobuild.com/about/>

Performance

The concept of the ventilated hollow core elements has two different modes of operation determined by the season. In summer mode excess heat from within the building is stored in the floor's mass during the day by radiation and natural convection, following the principle of (passive) thermal mass. During the night cold ambient air circulates through the cores and cools down the mass and building and enables a new cycle of excess heat storage during the following day. Simultaneously the cooled building mass can also pre-cool warm ambient air before being ventilated into the building during the day. In winter mode the stored heat during daytime is re-radiated back into the room during the night, also following the principle of (passive) thermal mass, and reduces the initial heat demand at the start of the next day. In addition, the hollow cores also enable the preheating of ambient air circulating through the cores before being ventilated into the building.

The principle of ventilated hollow core elements does not differ much from water-based thermo-activated building elements except for its transport medium. However, with ventilated hollow core elements the air running through the cores can not only (de)activate the thermal mass but can also be ventilated into the building.

The concept of ventilated hollow core elements is well-studied (Barton et al., 2002; Corgnati & Kindinis, 2007; Weitzmann, 2004; Winwood et al., 1997) and has found multiple practical implementations, although with a predominant focus on cooling demand reduction in office spaces. Winwood et al. (1997) studied different variants and configurations and assessed their performance by calculating the intrinsic storage capacity (i.e. the proportion of available energy transferred from the air to the thermal mass) and the effective volume (i.e. the amount of mass that interacts with the ventilation air). They came to the conclusion that lower air flow rates and longer channels (i.e. the distance air travels within the hollow core element) increase the thermal stability effect of the massive floor. Compiled from different studies, Barton et al. (2002) mention that air velocity rates of about 1 m/s enable thermal energy exchange between the air running through the hollow cores and the floor slab of 10 to 40 W/m².

In Sweden more experience has been gained with ventilated hollow core elements in apartment buildings (Strängbetong, 2011a). Such a system was integrated in a four-storey apartment building accommodating 16 units in accordance with the Passive House concept (Strängbetong, 2011b). The ventilated hollow core system is here used for space heating, cooling and ventilation. A ground-coupled communal heat pump system (8.4 kW) with electric auxiliary heating during the coldest periods, in combination with high thermal insulation, airtightness and thermal mass, is sufficient to meet the passive house standards. Ventilation air is introduced evenly throughout the dwelling and has a maximum temperature of 25°C in summer. During summer the hollow core elements are flushed with cooler air during the night to reset the heat storage capacity during daytime.

Process

As the result of a high flow resistance within the cores, natural air flows may not be adequate to provide sufficient ventilation. A reliable way to maintain sufficient air flow through the cores is by using fans. However, using the potential of natural forces such as the thermal stack effect and wind forces are preferable from an energy-saving point of view.

Winwood et al. (1997) stated that both floor and ceiling cover should be geared to the use of thermo-activated elements (i.e. limit barriers between mass and space, for example through insulation and false ceilings) to enable heat exchange between floor structure and the adjoining space. Otherwise the effectiveness of the system would drop dramatically.

Architectural consequences

Similar to the before mentioned thermal buffering and distribution principles, ventilated hollow core elements have minimal architectural impact. There is only need for registers in the floor or ceiling and an opening for the air intake.

Due to the difficulty to access and modify existing structural elements with hollow cores the concept is not particularly suited for renovation projects. The problem is not so much about adding air inlets and outlets but about connecting different cores in order to create a continuous air path.

§ 6.4 Passive solar heating

With passive solar heating the potential of the sun is employed for space heating purposes. The principle of passive solar heating is based on the collection of short-wave solar radiation by building mass that in turn disperses long-wave heat radiation, following the principle of thermal mass. Careful tuning of solar radiation collection, thermal conservation and diurnal storage decides to what extent solar radiation can contribute to annual space heating (Crosbie, 1998; Goulding et al., 1993; Hastings & Wall, 2007; Hestnes et al., 2003).

The three basic generic types of passive solar heating systems are direct, indirect and isolated. With direct systems transparent openings allow solar radiation to directly radiate the building mass in the interior of the building. The dispersed heat radiation is directly delivered to the indoor space. With indirect systems the exterior of the building mass is radiated by the sun. The absorbed heat then first needs to conduct through the mass before it can be delivered to the indoor space. Finally, with isolated systems solar radiation is collected and trapped in a place that has no direct thermal connection with the space to be heated. The heat is then transported from the isolated system when necessary.

Direct systems are more effective than indirect systems because solar radiation is absorbed by materials within the thermal envelope. The heat is trapped within the building. With indirect systems only part of the absorbed heat will conduct through the building skin and radiate to the indoor space. In addition, indirect systems may be in conflict with thermal conservation strategies (e.g. insulation). With isolated systems solar radiation is collected in a stand-alone collector that has no or limited direct thermal connection with the building (for example solar thermal collectors). The focus here lies on the direct and indirect systems that have a certain degree of architectural integration.

In order to trap solar radiation within a space the exposed building mass can be placed behind a layer of glass, because glass transmits short-wave solar radiation but reflects long-wave heat radiation dispersed from the building mass. The obvious way to allow solar radiation directly into the building is to strategically place windows facing the sun and using the space to be heated as the solar collector device. As an alternative to this system of direct solar gain (section 6.4.1) the solar radiation can also be pre-caught in some kind of buffer space which gives more control over the exchange of heat to the space that needs to be heated. Design solutions that make use of such buffer spaces are the thermal storage wall (section 6.4.2) and the sun space (section 6.4.3). As an alternative in high density developments where the façade has no direct access to the winter sun, the solar attic can harvest solar radiation at the roof. Since water is an excellent medium for thermal storage, the roof pond (section 6.4.4) is discussed here as well.

§ 6.4.1 Direct solar gain

In a direct solar gain system the interior building mass is directly heated by incoming solar radiation and captured heat is dispersed directly into the space that is to be heated. The living space functions as the solar collector which means that there is no need for thermal distribution, although collected heat can be distributed to other zones of the building. Solar radiation enters the building through all transparent openings and is stored in massive floor and wall elements.

Performance

The potential of catching solar radiation behind glass depends on relevant characteristics of the glass layer, which is discussed here, and the solar exposed building mass, which was discussed with the concept of thermal mass (section 6.3.1). The total amount of solar radiation that is transmitted through a glass layer is set by three design parameters: window orientation, window size and the energy transmission factor or g-value of the window. Window orientation and size determine the absolute amount of solar radiation that strikes the window surface (Figure 4.12).

The energy transmission factor (or g-value) of the glazing determines how much of that collected energy is transmitted towards the interior. The g-value is negatively influenced by special coatings that are used to reduce energy transmission of high performance double glazing in order to prevent issues of overheating in summer. Table 6.7 gives an overview of the performance of different glazing units.

GLAZING TYPE	Composition	U (W/m ² K)	g-value [-]
Standard double-pane glazing	4/16/4 mm Air fill	2.7	0.76
High performance double-pane glazing with low-emissivity coating	4/16/4 mm Air fill	1.4	0.64
High performance double-pane glazing with argon fill and low-emissivity coatings; different coatings decrease thermal admittance (U) but also lower the solar admittance (g-value)	4/16/4 mm Argon fill	1.2	0.64
	4/16/4 mm Argon fill	1.1	0.42
	6/15/4 mm Argon fill	1.0	0.28
Triple glazing with argon fill; different configurations lower the thermal admittance (U)	4/9/4/9/4 mm Argon fill	0.9	0.50
	4/12/4/12/4 mm Argon fill	0.7	0.50
Triple glazing with krypton fill	4/12/4/12/4 mm Krypton fill	0.5	0.60

TABLE 6.7 Comparison of energy transmission factors of different types of glazing systems (Saint Gobain, 2010).

Energy transmission factors vary widely from 0.76 for standard double-pane glazing to 0.28 for high performance double-pane glazing with special coatings. This difference implies a 48% reduced energy potential from the sun between both types of glazing. Alternatively, a better alignment between energy transmission factor and heat resistance could be found by using high performance triple glazing without coatings and applying (external) shading devices to prevent overheating issues.

Process

While the solar collector is at the same time a living space, the air temperature and its fluctuations must be controlled within a certain comfort range. This can be achieved by choosing a proper harmony between window geometry and placement, glazing type, the available mass during the times passive solar heating is desired and solar control measures to block undesired admission of solar radiation when no heating is desired.

Within this harmony the prevention of overheating and the containment of stored heat during the night are essential. To prevent discomfort due to overheating counter measures (e.g. solar shading) should be taken to eliminate incoming solar radiation when passive solar heating is not requisite. Furthermore, large transparent openings may cause privacy issues. The use of skylights or clerestory windows could solve these issues (section 6.6).

To ensure that the stored heat during the day is sufficient to compensate for the lack of solar radiation at night, nocturnal heat loss needs to be restricted. Especially with direct solar gain systems attention is required for the transparent openings while as a primary component in collecting solar radiation they typically insulate worse than opaque elements. Heat loss can be minimised by using high performance insulated glazing or a type of movable insulation that covers the window during the night (e.g. thermal shutters (section 6.2.2)).

Architectural consequences

The visual impact of direct solar gain solutions is minimal but can also be used prominently as a distinct architectural feature (Figure 6.16, Figure 6.17). Furthermore, the concept is well-suited for renovation projects; subject to the passive solar heating potential of the location. At smaller renovation works a passive solar heating strategy can easily be taken into consideration at window replacement selection (e.g. balance between thermal insulation, solar gain and sun shading). In large-scale renovation works complete façades can be replaced with enlarged transparent elements that fully adopt a passive solar heating strategy.



FIGURE 6.16 The sun-facing façade is almost completely transparent. Semi-detached passive houses in Bregenz, Austria by Walter Unterrainer. Reprinted from Walter Unterrainer Architektur Atelier website.



FIGURE 6.17 Transparent roof elements see supply direct solar gains in the common transfer space between the two dwellings. Patchwork-House in Müllheim, Germany by Pfeifer Roser Kuhn Architekten. Photo by Ruedi Walti.

§ 6.4.2 Thermal storage wall

A thermal storage wall consists of a layer of glass placed in front of a sun-faced wall with a small airspace in between. During daytime the wall absorbs solar radiation and heats up. After a certain delay part of the heat is conducted through the wall and radiated into the space behind (Figure 6.18) following the principles of (passive) thermal mass (section 6.3.1).

A Trombe wall is a special type of thermal storage wall with added vents at the base and top of the back wall (Figure 6.19). The vents allow for controlled circulation of air into the building. Therefore a Trombe wall provides space heating in a second way: air from the cavity can be directly let into the building.

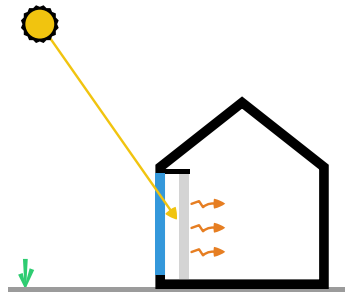

FIGURE 6.18 Thermal storage wall.

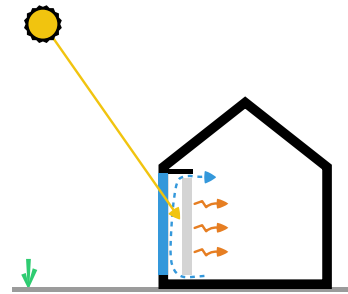

FIGURE 6.19 Trombe wall.

Performance

The rate at which heat is conducted through the wall depends on the chosen material (see thermal mass, section 6.3.1) and the thickness of the wall. A massive wall is typically made from masonry or concrete and is commonly designed as part of the building structure. Alternatively, a lighter construction containing a water tank can be used. A water wall can be more effective because water has a much larger heat capacity than concrete or masonry walls and because convection currents distribute heat much quicker through the wall. It should be noted that the material of the water storage containers is an important factor in the overall performance of such systems. If massive or water walls require too much space, phase change materials (PCM) can be used to require similar heat storage capacities at lower volumes.

The overall performance of a thermal storage wall can be improved by increasing the amount of solar radiation that hits the storage wall and by eliminating heat emission to the ambience during the night. The solar radiation exposure of a thermal storage wall can be increased by using reflective surfaces (e.g. light-coloured pavement, water bodies) that reflect solar radiation towards the glass. This will increase the effectiveness of the system since more solar radiation can be harvested with the same collector size (Figure 6.20). In addition, a movable insulated layer placed in front of the storage wall eliminates heat loss to the night-sky. When a reflected coating is applied to the inner surface of the rotatable insulated layer the same element can accomplish both functions in one (Figure 6.21).

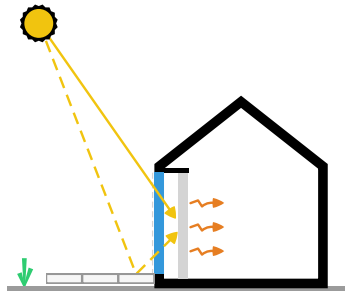

FIGURE 6.20 A reflecting pavement next to the building reflects solar radiation to the thermal storage wall.

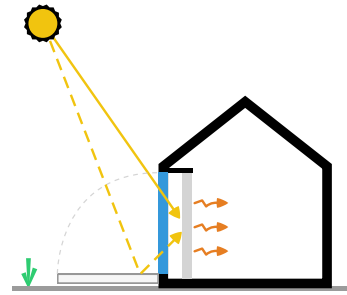

FIGURE 6.21 A reflecting surface at the inside of the movable cover reflects solar radiation to the thermal storage wall. When the sun sets the cover is placed in front of the thermal storage wall minimizing heat loss to the night sky. The cover can also add an extra layer of insulation. Concept developed by Steve Baer (Lechner, 2001).

Process

When solar radiation collection is undesired the thermal storage wall can be protected from the sun's rays by solar shading devices or the absorbed heat can be flushed by abundant ventilation of the air gap between the glazing and the absorbing wall. Increased insulation values of the glazing or movable insulation can be applied to prevent heat loss at overcast skies in colder periods or at night.

An advantage of thermal storage walls over direct solar gain systems is the absence of possible issues with glare, privacy and degradation of fabrics due to light from the ultraviolet spectrum.

Architectural consequences

The transparent layer in front of an opaque wall is a distinct architectural feature that has a clear visual impact on the building; possibly integrated in the façade that allows access from the exterior (Figure 6.22).



FIGURE 6.22 In a single-family house a Trombe wall is applied in lightweight structures and PCM modules are fixed to the back wall to add 'thermal mass'. The glass layer can be opened to flush the air cavity and prevent overheating in hot periods. Norton Summit 1, Adelaide, Australia by John Maitland. Reprinted from Energy Architecture website.



FIGURE 6.23 A spandrel wall executed as a loam thermal storage wall, here flanked by solar cells. The façade also contains windows to admit direct sunlight and provide views outside. Wohnhaus M by Martin Rauch and Robert Felber. Reprinted from Lehm Ton Erde website.

Thermal storage walls are possible in renovation projects. Thermal storage walls can be created by placing a glass layer in front of existing solar-exposed massive wall elements. If these wall elements are well insulated from the inside the best option is to transform the system into a Trombe wall that will predominantly provide heat from air circulation in the cavity; since the insulation layer will reduce the heat transfer through the massive wall (Figure 6.23).

§ 6.4.3 Sunspace

A sunspace (or solarium, solar house, greenhouse, winter garden or conservatory) is a transparent building extension placed outside the thermal envelope of the main building. During the day the sunspace will heat up under the influence of incoming solar radiation and will, in its basic function, act as a thermal buffer space. It shares similar functionality as a thermal storage wall but the sunspace is large enough to be used as an additional living space; only when the climate is not too severe.

Performance

In its most simple form a sunspace acts as a thermal buffer space, minimising heat losses of the main building. Due to its construction a sunspace heats up (and cools down) much quicker than the main building. Alternatively, the sunspace can also be used to preheat ventilation air. By equipping the sunspace with large transparent areas and minimal insulation, the sunspace will respond more quickly to changes in temperature and solar radiation. The temperature in a sunspace will then be some degrees higher than ambient temperature (Oliveti et al., 2012). In winter this collected heat can be used to preheat ventilation air for the living spaces of the main building by opening doors and windows to the sunspace. In summer the temperature of the sun space will be too severe if no additional measures are taken. These measures may include (additional) insulation of the separation wall to the main building, shading of the sun space roof and abundant natural ventilation of the sun space to flush excessive heat.

The potential of the sunspace is illustrated with the Glass House dwellings by KWSA architects (Figure 6.26). The operational performance of the Glass house dwellings was part of an extensive research project in which expected performance of the dwellings was compared to monitoring results obtained during occupancy (Kalkman & Willems, 2003). The average indoor air temperature of the living room during a persistent hot period in summer measured 24.2°C (Figure 6.24, 1). When the ambient temperature drops to a low 15.3°C early in the morning, the temperature of the sunspace and the core dwelling have dropped to respectively 17.5°C and 21.4°C. The temperature inside the core dwelling reaches a maximum of 25.8°C at the end of the day. To control the indoor temperatures the core dwelling can be cooled down when ventilated directly with the cooler ambient air in the evening and at night, and from the base of the sunspace in the morning until the afternoon. The temperature in the base of the sunspace is much cooler than ambient temperature, which can be explained from the large thermal capacity of the soil. The temperature development of the core dwelling shows a slight heat accumulation under these severe climatic conditions.

Measurements for a typical sunny, mid-season day (Figure 6.24, 2) revealed that the average temperature in the sunspace throughout the night is some degrees higher than the ambient temperature. The temperature in the lower part of the sunspace (base) stays much below the temperatures measured on elevated heights (front and roof) and reaches a maximum of 23°C. The temperature course of the core dwelling shows no heat accumulation under these climatic conditions.

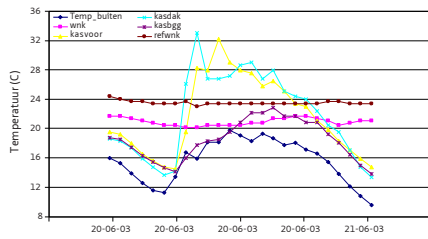

1 Summer.

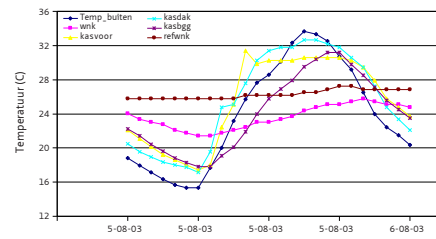

2 Mid-season.

FIGURE 6.24 24H temperature development for different parts of the Glass House dwellings. Adapted from Kalkman & Willems (2003).

The assessment of comfort perception of the occupants revealed that the core dwelling was considered warm, but comfortable. Remarkably, the sunspace was considered to be as comfortable as the core dwelling while its temperature is most of the time several degrees higher. Apparently the occupants accept higher temperatures in the sunspace than in the core dwelling. As from October, the sun space is considered to be too cold.

Computer simulations on the effect of the presence of the solar space on the heat demand of the core dwelling showed a net decrease of 2 GJ. A 2.9 GJ decrease in transmission losses is partly counterbalanced by a loss in passive solar gains of 0.9 GJ.²³

Process

In urban environments, solar exposure of individual houses is constrained by street layouts and the shape of neighbouring buildings. Obstructions put restrictions on the solar exposure of transparent openings in the building skin and thus on the potential of solar radiation in a passive solar heating strategy. An extensive study was conducted into the effects of urban parameters (street width and orientation) and architectural parameters (roof shape and building envelope design) on solar access to the urban canopy and the viability of passive solar heating strategies in residential buildings (Looman & Van Esch, 2010; Van Esch et al., 2012). In a typical urban layout with a street width of 15 m during the winter when sun angles are low, approximately 70% of the sunlight to which a building is exposed to is harvested at the roof and the topmost floor. This would favour the positioning of the sunspace on top of the building. This concept of a solar attic functions similarly to that of other indirect solar heat gain systems but with enlarged solar exposure and less obstruction from neighbouring objects the solar attic can still be effective in denser urban developments.

23

However, actual energy use measurements during occupancy showed occasional primary energy demands up to 120% higher than what pre-design calculations predicted. This was validated by dynamic computer simulations and were explained from 'excessive' ventilation of the core dwelling (i.e. ventilation rates that are much higher than the (Dutch) building regulations prescribe in order to maintain healthy indoor air quality standards).

Architectural consequences

Sunspaces exist in many sizes, ranging from attached to a single floor or an entire façade (Figure 6.25) or even spanning the whole building (Figure 6.26). This latter concept creates additional living spaces outside of the core building that can be put to use depending on activity and time of year. The development of the Prêt-à-loger house, the entry of Delft University of Technology for the 2014 Solar Decathlon, illustrates the potential of remodelling houses with sunspaces - accompanied with other design solutions - since they are merely an extension (Figure 6.27). However, this will claim space from the surrounding property turning outdoor space into semi-indoor space.



FIGURE 6.25 Eco-dwellings Carisven, Heerlen, the Netherlands by Renz Pijnenborgh. Photo by Gerlach Delissen.



FIGURE 6.26 Glass covered dwellings; Glass house dwellings in Culemborg, the Netherlands by KWSA. Photo by KWSA.



FIGURE 6.27 Sunspace in renovation, Prêt-à-loger house, entry of Delft University of Technology for the 2014 Solar Decathlon.

§ 6.4.4 Roof pond

In arid areas a roof pond is typically designed as an open pool on the roof and functions as a passive cooling system where it benefits from the evaporative cooling effect. By covering the roof pond and control the aperture of the pool to the sky the concept can become beneficial in colder climates as well (Juanicó, 2008). Such a roof pond has four configurations, depending on season (summer, winter) and time of day (day, night). In summer, at night-time the roof pond is exposed to the sky and heat can dissipate away. At daytime an insulated cover is placed on top of the roof pond to prevent solar radiation to heat the water and to provide passive cooling to the building in the form of a cooled ceiling (Figure 6.28, 1). The same concept can also be used in the heating season. In winter, during the day the roof pond is exposed to solar radiation and stores heat. The effectiveness can be increased by covering the roof pond with a layer of glass. During the night an insulated layer covers the roof and the stored heat is delivered to the building (Figure 6.28, 2).

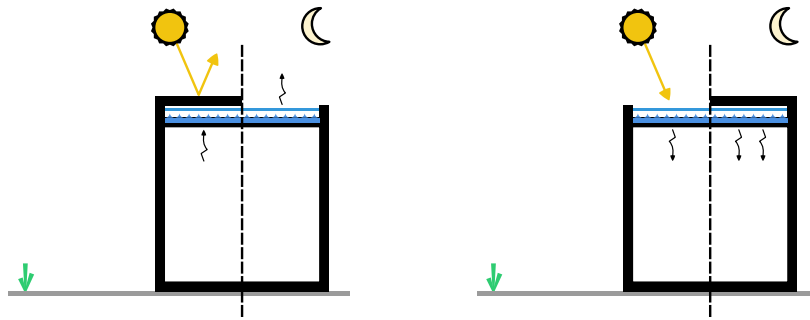

1 Summer: during the day the roof pond stores excessive heat from the building. At night the roof cover is removed and the stored heat can dissipate away.

2 Winter: a glass cover lets the roof pond function as a solar thermal collector. The roof pond is covered during the night to minimise heat emission to the night sky.

FIGURE 6.28 Roof pond operation in summer and winter.

Performance

Extending the size of solar thermal collectors to the whole available roof area will suffice most of the space heating demand for houses up to latitudes of 37° (Hassan & Beliveau, 2007). Moving further away from the equator will generally result in increased heat demand and reduced solar radiation levels. Still, roof ponds can be quite beneficial at higher latitudes. For example, a flat roof of a typical row house in the Netherlands is exposed to approximately 0.5 kWh/m^2 of solar energy (G'') on a winter day. The daily amount of collected energy is:

$$E_d = G'' \cdot \eta \cdot A \quad (\text{kWh}),$$

where the efficiency of solar collection η is 0.5, similar to flat thermal collectors and the roof area A is 52.4 m^2 . The total daily amount of collected energy is 13.1 kWh , roughly 25% of total energy demand for space heating during a winter day for a typical house in the Netherlands. The effectiveness of a roof pond system can be enhanced by reducing the heat loss and by harvesting more solar energy by integrating the roof pond in an inclined roof. As an alternative to a movable cover, when exposure to solar radiation is undesired, a storage tank and piping can distribute the heat throughout the building (Juanicó, 2010).

Process

When applying a roof pond system the roof structure needs to be capable of carrying the extra load. In addition the structure should be conductive to allow the stored heat to be transported to the underlying zones, preferable the zones that require the most heating.

Roof ponds can be seen as a low-tech (and low cost) version of water-based solar thermal collectors.²⁴ Roof ponds can also be designed as a series of water bags (Raeissi & Taheri, 2000). The use of water bags makes the system modular and also applicable in sloped roofs which harvest more solar energy in winter at higher latitudes. The use of dark-coloured bags can further enhance heat absorption.

Architectural consequences

Roof pond structures have a low visual impact on the design. Roof pond systems are suitable in renovation projects on condition that the structure is able to carry the additional load and is able to conduct heat sufficiently towards the interior or is backed up by an alternative distribution network.

§ 6.5 Earth-coupling

The general idea behind earth-coupling is to take advantage of the earth's large thermal storage capacity. Ground temperatures are becoming more stable at relatively small depths because the dynamic ambient conditions are dampened out and follow local annual average ambient temperatures.

In direct systems the interface between building and the ground is employed directly; the direct contact a building makes with the underlying earth enables thermal energy exchange through conduction. Typically, a building's ground floor slab is in direct contact with the soil underneath and can be designed to harvest energy from the ground. As an alternative to the direct contact foundation slab (Figure 6.29, 1; section 6.5.1) the building can also be (partially) buried in the ground or covered with earth to increase the area of interface. This technique is called earth shelter (Figure 6.29, 2; section 6.5.2), referring to the protective function a buried or covered building gets from harsh climate conditions.

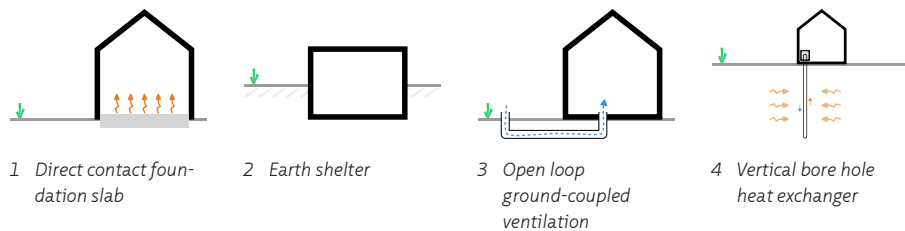

FIGURE 6.29 Earth coupling principles.

The earth's large thermal capacity can also be employed using buried transport systems (e.g. tubes, pipes) in which a transport medium runs that harvests the heat from the soil. For example, in an open loop ground-coupled ventilation (Figure 6.29, 3) system buried ducts are used to precondition ventilation air before it is introduced into the building. Isolated systems have no direct thermal connection to the building where the exchanged energy is centrally collected and then transferred to the building when needed, using a (central) distribution system. Such ground-coupled heat exchanger systems consist of either an open-loop system where groundwater is extracted from the ground or a closed loop system where one or more buried tubes in which a transport medium (typically a mixture of water and antifreeze) runs and exchanges energy with the surrounding soil. The tubes can be placed in a vertical setup (vertical borehole heat exchangers; Figure 6.29, 4) which requires drilling holes or placed horizontally in trenches which eliminates the need for drilling holes but does require more use of land. The exchanged energy is centrally collected and then most commonly transferred to the building's central heating system (with the possibility of upgrading first). Alternatively the extracted energy from the ground can also be used to preheat ventilation air that is directly drawn from outside (closed loop ground-coupled ventilation). Closed loop ground-coupled systems can also be incorporated in the structural elements of the foundation (e.g. diaphragm walls, foundation slab and construction piles). The use of absorber diaphragm walls, foundation slab with absorber lines and energy piles (section 6.5.3) eliminates the need for separate heat exchanger systems that are to be placed within the soil.

Only the design solutions that have a certain degree of structural or architectural integration (i.e. direct contact foundation slab, earth shelter and energy piles) are discussed here in more detail.

§ 6.5.1 Direct contact foundation slab

The direct-contact foundation slab is specifically designed to be in direct contact with the earth below the building in order to enable interaction with the earth's large storage capacity. This type of direct earth-coupling uses standard building elements.

Performance

Since ground temperatures are typically below the lower boundary of the comfort zone the concept has most potential delivering free cooling. Therefore, the concept is rarely used in temperate and cold climates due to expected decreased overall performance in winter. For example, a typical R_c value for the ground floor slab in the Netherlands is $4.0 \text{ m}^2\text{K/W}$ which more or less disconnects the building from the ground underneath. However, free cooling can still be employed in temperate climates when the concept is combined with variable insulation, for instance through adaptable insulation (section 6.2.1).

Process

When the building is not disconnected from the soil underneath by a certain degree of insulation, the ground is warmed by a downward heat flow from inside the building and potentially from (direct) solar radiation. Since the temperature of uncovered soil follows mean ambient temperatures heat will dissipate away at the perimeter of the building (block). More to the centre of the ground floor slab the earth-coupled heat exchange will be more downwards (Figure 6.30). Eventually this will result in a stable temperature gradient directly underneath the building. If this exchanged heat is contained underneath the building it will function as a thermal storage device. Heat containment focussed on minimising thermal leakage near the perimeter of the building is best achieved through a layer of insulation that extends deeper into the ground, if desired extended with a vegetated grade cover. Expected behaviour of the thermal storage system can be disrupted by groundwater flows which can both flush heat away or on the contrary restore the stock of thermal energy.

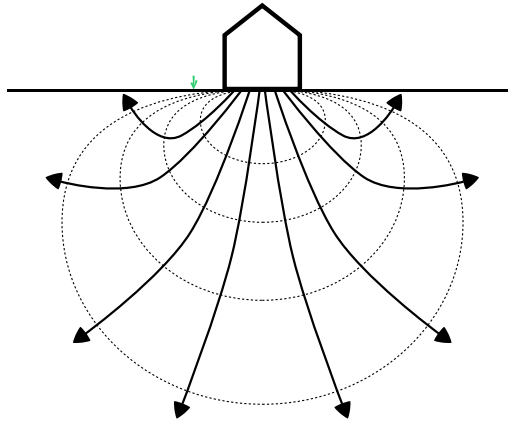

FIGURE 6.30 The direction of heat flow from the building to the ground. The heat flow near the perimeter of the building (block) is pointed towards the surface while the heat flow from the middle of the ground floor slab is pointed downwards. After Watson & Labs (1983).

Architectural consequences

Ground-coupled foundation slabs differ not so much from conventional ground floor slabs except for the specific attention given to the thermal conductance of the slab. There is no visual impact on the building design.

§ 6.5.2 Earth shelter

Through existing or man-made landscaping buildings can be sheltered from harsh climatic conditions (e.g. strong winds, extreme temperatures) when (partially) buried in the ground. In addition, earth sheltered buildings deploy the large thermal storage capacity of the earth to reduce heating demand in winter and promote passive cooling in summer because ambient air temperature fluctuations are more tempered when going deeper underground and do follow the annual average ambient air temperature.

Earth sheltering has different basic forms (Figure 6.31). When excavated the building is placed below surface grade realised through excavation. In a bermed setup the building is constructed at surface grade while earth is bermed up against its walls. Finally, with hillside earth shelter the building is integrated into existing hilly landscape.

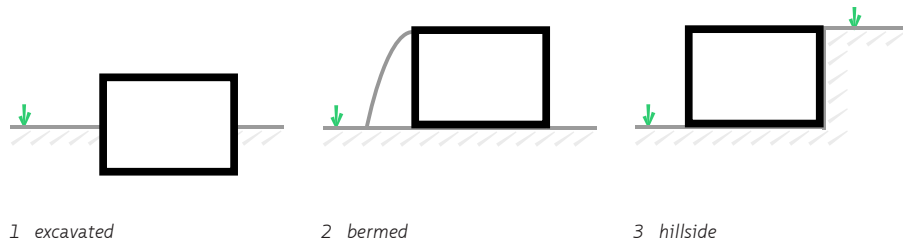

FIGURE 6.31 Different types of earth-sheltered dwellings.

Performance

The potential of earth shelter strategies depends on the building's heating and cooling demand in respect to the difference between the air and ground temperature. In windy climates, earth sheltering provides buildings with a natural wind screen that limit heat loss. It is noticed that earth-sheltered design is beneficial in any climate (Anselm, 2008; Carpenter, 1994; Kumar et al., 2007). In colder climates earth-sheltered design reduces heat transfer rates and heat loss through the structure.

The Honingham earth-sheltered social housing project in the United Kingdom (Figure 6.32) by architect Jeremy Harrall validates the potential of earth sheltering. All but the south-facing wall of the dwellings are covered by a thick layer of earth. The dwellings use a wide plan that allows every single room to be naturally lit and heated by the sun. The building has high thermal mass and improved thermal insulation. Without the use of any additional heating system, in fact the dwellings don't even have one, the temperature inside maintains at a comfortable 22°C in winter. The use of solar collectors and efficient lighting limits the occupancy costs for the tenants.

Process

Special attention to daylight admission and ventilation is needed when buildings are (partially) buried, since they are exposed to a smaller outdoor environment to interact with. A waterproof substructure is essential in areas where groundwater levels are high. Furthermore, high humidity levels during warmer periods can cause issues of condensation when no countermeasures are taken to the surfaces that are in direct contact with the much cooler earth.

Architectural consequences

Earth sheltered houses are characterised by a building plan which only has limited direct connection to the ambient air and thus require specific attention to ventilation and daylight entry. A partially buried dwelling has a distinct visual appearance and is only viable in newly-built developments because of their specific style in planning and construction (Figure 6.32, Figure 6.33).



FIGURE 6.32 Honingham Social Housing, United Kingdom by SEArch architects is constructed at surface grade with a bank of earth bermed to its outer walls. Reprinted from SEArch architects website.



FIGURE 6.33 Villa Vals, Switzerland by SEARCH and CMA is constructed in existing hillside. Photo by Kecko.

§ 6.5.3 Energy piles

The soil conditions in some parts of the Netherlands make that buildings require construction piles or other foundation elements. Combining ground-coupled heat exchangers in load bearing substructures eliminates the need for a separate earth-coupled heat exchanger and accompanying actions for installation. Most well-known in the Netherlands are the use of energy piles. Energy piles are like ordinary construction piles, but besides provision of support to the building structure they also function as a heat exchanger with the earth's large thermal storage capacity.

Energy piles are constructed with a system of embedded tubes which contain a heat transport medium. This transport medium is used to exchange energy between the building and the soil underneath. During the heating season heat is extracted from the soil and delivered to the central heating system; typically upgraded using a heat pump. In summer periods this process can be reversed. Excessive heat is taken from the building and transported to the earth surrounding the energy piles, thereby providing (free) cooling to the building.

Performance

The performance of a whole system using energy piles depends on the soil characteristics, the building's heat demand and the energy pile configuration (TNO-MEP, 2003). The heat-exchange capacity of a single pile is bounded by its length, the distance to other energy piles and used type (i.e. materialisation and loop configuration). Longer and slimmer piles are able to extract more heat from the ground. However, the active length of a pile is determined by structural considerations, i.e. the depth of the bearing layer. Whole system capacity is determined by the active length of all piles together. More piles means more capacity; in theory. When distance between the piles becomes too small the capacity of the system decreases because piles extract heat from the same source and total performance will drop.

Typical energy piles incorporate one or more HDPE²⁵ tubes in a concrete pile, which has good thermal characteristics (e.g. thermal capacity and conductivity) for use in earth-coupled systems, and are capable of 30 - 35 W/m of heat extraction when applied in common soil conditions (i.e. sand and clay) (TNO-MEP, 2003). Different soils, the water table and groundwater flow activity influence heat extraction capability. Table 6.8 gives an overview of the monitored heat exchange capacity of two buildings equipped with energy piles.

PROJECT	Setup	Specific heat extraction capacity in heating mode (W/m)	Specific heat exchange capacity in cooling mode (W/m)
Detached dwelling in Schemerhorn, The Netherlands by architect Sander Douma (1999)	30 energy piles with an effective length of 428 m	[unknown]	17.3
Detached dwelling in Kampen (2005)	21 energy piles with effective length of 210 m	25.7	38.1

TABLE 6.8 Specific heat extraction capacity of energy piles as monitored in existing projects (Kalkman, 2007; TNO-MEP, 2003).

Long-term performance of energy piles is guaranteed when the amount of heat extracted from the subsurface is equal to the amount of energy stored in return. For instance, if more heat is extracted than restored the source will deplete and system efficiency will eventually drop. Restoring the energy balance of the soil is called regeneration. This is valid for all types of ground-coupled systems that harvest larger amounts of energy from the ground. If the annual heating and cooling demand of the building is not in tune, complete regeneration of the soil can be accomplished by collecting additional heat from solar radiation with thermal collectors.

Process

Since load-bearing is the primary function, the energy potential of energy piles is bounded by structural performance. When too much heat is extracted from the soil it could freeze, which in turn can cause severe damage to the construction pile and even lead to failure (i.e. loss of bearing performance). In order to increase the effectiveness of the whole building system (e.g. increase the share energy piles contribute to the heating demand) measures should be taken on the demand side of heating (e.g. thermal conservation, thermal buffering, etc.) rather than on the supply side (i.e. installing more piles or extract more heat from the soil).

Architectural consequences

The application of energy piles or other ground-coupled foundation elements does hardly differ from conventional, non-ground-coupled foundation elements and has no visual trace on the building design.

§ 6.6 Natural illumination

Windows are the primary and most common solution to admit daylight into a building. In addition, windows play an important role in a passive solar heating strategy when the sun is harvested directly. As mentioned before large transparent openings can cause problems with overheating in warm periods as well as discomfort due to bright levels of light. These issues can be managed by proper sun control measures that often inextricably connect both strategies of natural illumination and solar shading. Daylight systems, solutions that primarily focus on natural illumination, are discussed in this section. Solar shading is discussed in section 6.7.

Beside the use of a window or other strategically placed transparent openings such as the clerestory window and the skylight (all discussed in section 6.6.1), there are different ways to control the amount of daylight and improve its quality. [Table 6.9](#) presents an overview of different daylight systems, categorised according to principle of light control and its responsive method.

		LIGHT CONTROL BEHAVIOUR		
		light scattering and filtering	light redirecting	light distribution
responsive methods	non-adaptable measures	translucent insulation	light-redirecting window systems light shelves	light tubes optical fibres fresnel lens
	adaptable measures	user-intervention		switchable window systems
		automated		
	intelligent		heliostats	
	smart materials			

TABLE 6.9 Overview of daylight systems categorised according to their light control behaviour and its responsive method.

Light scattering systems transform direct sunlight into diffuse sunlight. Such systems include translucent insulation (as discussed before in section 6.2.3) and switchable window systems (section 6.6.3), an umbrella term for window systems that are able to change their optical characteristics such as opacity and heat and light transmittance.

Light redirecting window systems redirect daylight to get improved levels of natural light or a better spatial distribution. Such systems include light-redirecting glazing, where incoming light is redirected as the result of a glazing-embedded property or from an additional layer within a window system (section 6.6.2), and light shelves (section 6.6.4), architectural elements that at the same time provide shading.

Light distribution systems transport light throughout the building. A light tube consists of a collector unit in the building envelope that harvests the sunlight, an amplifier unit (a narrow tube lined with a reflecting material) that redirects the harvested light further along the tube and a diffuser unit that emits the light into the building. Alternatively, light can be transported much more effectively over longer distances using optical fibres, merely the same wiring that is used in the communication industry. Other solutions are the use of a fresnel lens or a heliostat, a sun-tracking mirror structure that redirects sunlight to a second mirror or other fixed collector element. All of these light distributing systems have limited architectural implementation, although the proportion of a heliostat can be considered otherwise, and are therefore not discussed into more detail as part of this dissertation.

Despite the fact that well-designed daylight systems will result in a more balanced naturally lit indoor environment their employment is still limited; certainly regarding residential projects. Relatively large windows and high ceilings are often sufficient to allow plenty of daylight into houses that are characterised by a compact form, individual daylight control and less stringent lighting requirements opposed to non-residential buildings (e.g. offices, schools). However, possible issues of overheating when using large windows require counter measures such as shading or passive cooling. The daylight systems as presented here can provide a solution as well; particularly in renovation projects.

§ 6.6.1 Windows and skylights

Windows are the common solution to admit daylight into a building, and therefore minimise the need for artificial lighting. In addition, windows also have the social function of connecting the indoors with the outdoors. Therefore, windows are typically placed in a vertical position and at eye-level. When specific daylight admittance or privacy needs are to be met windows can be positioned in the building envelope differently. For instance, clerestory windows or skylights may better suit such needs. A clerestory window is a vertical window placed above eye-level (Figure 6.34) and allows daylight deeper into the building. Since their placement is above eye-level clerestory windows can also eliminate possible privacy issues. Skylights are windows placed in the roof of a building (Figure 6.35). Due to their orientation, skylights see part of the zenith and therefore admit more light per unit area than ordinary windows at overcast sky conditions (section 4.2).

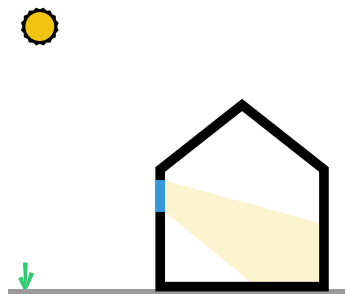

FIGURE 6.34 Clerestory; window placed above eye-level that allows light to enter deeper into the room and prevents possible privacy issues.

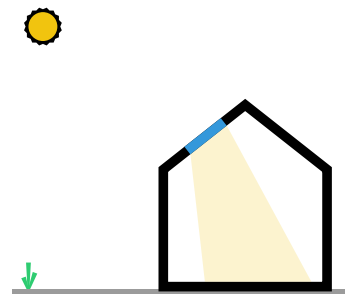

FIGURE 6.35 Skylight; window placed in the roof of a building. Since a skylight is facing towards the zenith it admits more light per unit area than vertically placed windows.

Performance

One way of daylight quality assessment of indoor spaces is by calculating the daylight factor, the ratio of illuminance perceived inside to ambient levels. The daylight factor is a 'worst case scenario' calculation using an standardised overcast sky (NEN, 2004) which makes the determination location and orientation independent. Figure 6.36 shows the effect of window size, shape and position on daylight distribution. The study shows that taller windows allow daylight to penetrate deeper into the room and wider windows generate more daylight spread from side to side.

Minimum requirements on daylight admission as put down in Dutch standards demand a window sized 10% of the habitable area that lies behind, with a minimum of 0.5 m². The minimal required window size is greater when the window is subject to the presence of on-site obstacles and overhangs or includes glazing with a Light Transmission Factor below 0.6. Furthermore, parts of transparent openings that are below 0.6 m above floor height are not taken into account.

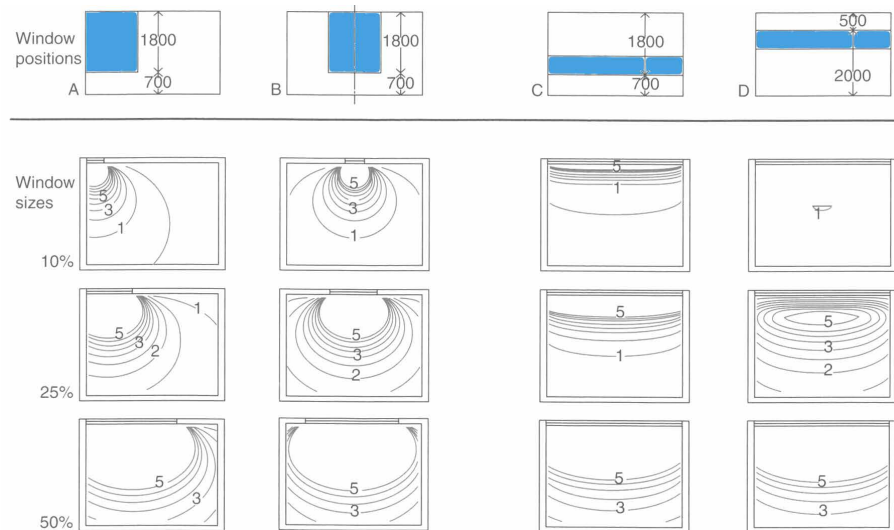

FIGURE 6.36 The effect of window size, shape and position on daylight distribution, represented by the daylight factor. Window sizes of 10%, 25% and 50% of available wall area is considered for different positions: A) fixed height, fixed at side, variable width; B) fixed height, placed at center, variable width; C) Variable height, fixed at sill, full width; D) variable height, fixed at head, full width. Adapted from Szokolay (2008).

Process

Daylight optimisation is predominantly determined by building form and layout on the one hand, and window geometry, arrangement, orientation and glazing type on the other. A large ratio of transparent openings to building volume will increase daylight factor, but all of this is at odds with a thermal conservation strategy. Alternatively, in compact design the use of atria or skylights can increase daylight admission to sufficient levels. Regarding the layout, zones that require the most levels of daylight can be positioned near the outer perimeter of the building. Furthermore, reflective indoor surfaces allow daylight deeper into the zone. Window type, geometry, arrangement and orientation must be considered for the specific location. The presence of neighbouring buildings, vegetation and (fixed) awnings are all of influence on the amount of daylight that strikes the façade. A window to wall ratio of 30% (Yanovshtchinsky et al., 2013)

can be seen as a rule of thumb for the Netherlands, where proper shading measures for sun-facing windows and anti-glare measures for windows facing east and west always need to be taken into consideration. Placing windows away from the edges and putting them higher up in the façade (i.e. clerestory windows) is beneficial for the daylight factor. Finally, the light transmittance of the glazing determines which part of the daylight that strikes the glass is passed to the interior, and is closely related to solar energy transmittance (g-value).

Window design, combined with shading design, is closely tied to both summer and winter performance. In summer excessive solar access can cause issues of overheating and in winter a large share of transparent openings in the building envelope may conflict with a thermal conservation strategy since the thermal resistance of transparent elements is generally worse than of opaque elements.

Architectural consequences

According to Le Corbusier "Architecture is the masterly, correct, and magnificent play of masses brought together in light."²⁶ Light is an important aspect of architectural design and the availability of sufficient daylight is important to human well-being. The use of clerestory windows or skylights can be beneficial in long-stretched buildings or in a dense urban context with reduced natural light offer. Sufficient daylight admission from such solutions can be obtained with distinct architectural impact (Figure 6.37).



FIGURE 6.37 House Uesslingen by Spillmann Echsle Architekten features a saw tooth roof with skylights to allow more daylight into the building. Photo by Spillmann Echsle Architekten.

§ 6.6.2 Light-redirecting window systems

Light-redirecting window systems have the specific function of redirecting incoming sunlight. It uses techniques that either block direct radiation or redirect it towards the ceiling of the interior, depending on the angle of incidence. Light at other angles can pass unhindered.

Light-redirecting window systems need to be specifically manufactured since the light-redirecting behaviour is angle-sensitive; subject to window orientation and inclination with respect to the sun's trajectory at the building location. Alternatively, such elements can be mounted onto movable elements that are able to track the sun and thus redirect light during stretched periods of time (Boubekri, 2008; James & Bahaj, 2003).

Light-redirecting behaviour can be achieved from various principles. Most common are prismatic or holographic techniques and laser-cut panels (Edmonds, 1993; Müller, 1994; Tholl et al., 1994). Both prismatic and holographic techniques can be applied to a window system by either substituting standard glazing with prismatic or holographic glazing or by including a separate sheet or film. With laser cut panels a laser makes incisions in an acrylic plastic panel. The depth and inclination of the cuts and the distance between the cuts determine the panel's light-redirecting behaviour.

Performance

A relatively cheap way to add prismatic behaviour to a window system is the use of a prismatic film placed in-between a (highly insulated) double-pane glazing system (ISFH, 2011). The effective g-value of a prototype window developed by the Institute for Solar Energy Research Hamelin (ISFH) was derived during field measurements. With respect to direct solar radiation the g-value switched from 0.52 in winter mode to 0.12 in summer mode; contributing to a reduction of 40% in solar heat gain (Figure 6.38). The overall U-value of the prototype was measured to be between 0.5 and 0.7 W/m²K, which is similar to triple glazing.

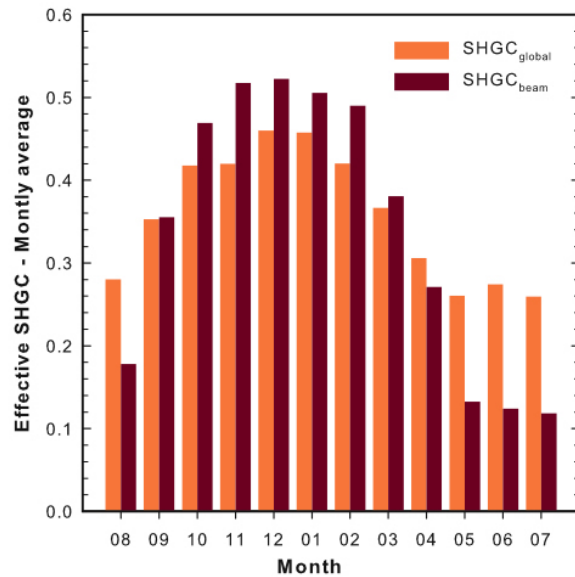
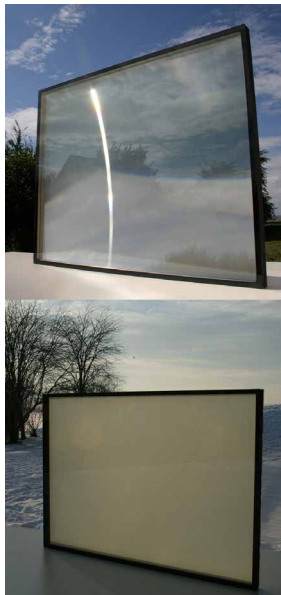

FIGURE 6.38 Effective solar heat gain coefficient (SHGC) or g-value of a double-pane window with an embedded prismatic foil. The average g-value for direct solar radiation (beam) varies from 0.5 in winter to 0.15 in summer. Reprinted from ISFH (2011).

Process

Large prismatic or holographic elements and large cuts in a laser-cut panel obstruct views to the outside. This is usually no problem when light-redirecting elements are used in skylights or clerestory windows. For use in conventional windows (i.e. windows typically used to provide views outside) reducing the size of the light-redirecting elements will improve the view out but simultaneously increase the risk of glare. As with any daylight system light-redirecting windows are bounded by the entirety of considerations on daylight admittance, glare prevention, solar shading and outside view.

Architectural consequences

The visual impact of light-redirecting window solutions is low although large light-redirecting features become visible to the eye. Alternatively, a compact light-redirecting element integrated into the upper part of ordinary, thin window systems is less noticeable (Figure 6.39). When the light-redirecting behaviour is embedded in movable elements this will not only improve the effective use of the system as a whole but can also become a distinct architectural feature.

Light-redirecting window systems may be beneficial in projects that cope with low levels of natural light as the result of stretched building plans or limited solar access as the result of a dense urban context. In particular, light-redirecting techniques may be a proper design solution in renovation projects with relatively small transparent openings where daylight issues need to be overcome with minimal adaptation to the façade or window system.



FIGURE 6.39 The LightLouver is a light shelf solution of minimal proportions which makes it easy to use in renovation projects. Old National Bank headquarters, Evansville, United States by HOK. Photo by LightLouver Daylighting System – Copyright 2002, Michael J. Holtz, LightLouver LLC.

§ 6.6.3 Switchable window systems

Switchable window systems are able to change its optical characteristics (e.g. reflectance, transmittance or opacity). A distinction can be made in active and passive systems. Active systems require an intervention in order to alter their optical characteristics, either from user intervention or any automated process. Passive systems are self-regulating since their optical characteristics alter with changing temperature or light incidence. Other denotations for this concept are smart, dynamic, advanced or chromogenic.

Active systems include electrochromic (EC) and gasochromic (GC) techniques (Somani & Radhakrishnan, 2003). Electrochromic glazing is activated by adding an electrical current to a coating. The electrical current modifies the structure of the coating which causes it to change colour and with that alter the light transmittance (Papaefthimiou et al., 2006). Gasochromic glazing is typically activated by the introduction of diluted hydrogen to a coating. Similar to electrochromic glazing the coating will change colour which influences the light transmittance, but not the ability to see through (Figure 6.40). The removal (or replacement) of the hydrogen with oxygen causes the glazing to revert to its original state (Wittwer et al., 2004).

Other types of electrically activated glazing make use of liquid crystals or dispersed particles that change their orientation when a current is applied. The glazing then changes from transparent to opaque (Figure 6.41). Such systems do not affect overall transmittance of light and energy, but are applicable as privacy glass.

Passive systems consists of two layers of glass with a solar-sensitive substance in between (Lampert 2004; Seeboth et al., 2000). Thermotropic (TT) and thermochromic (TC) glazing are manufactured with a temperature-sensitive substance. They differ in the way they behave upon a change in temperature. Thermotropic glazing is able to change its reflective properties while thermochromic glazing controls energy transmittance by changing its colour. With photochromic (PC) glazing the substance is sensitive to variations in light exposure. Photochromic glazing then alters its colour to control energy transmittance.

Switchable window systems show different behaviour than light-redirecting window systems since it can actively or passively change its optical properties after assembly. Light-redirecting window systems, on the other hand, rely on static behaviour based upon a certain glass treatment chosen following specific comfort demands and local conditions; apart from the fact that light-redirecting behaviour can also be incorporated into movable elements.



FIGURE 6.40 An invisible chromogenic layer is colourless when in contact with oxygen but turns bluish when in contact with a small amount of hydrogen. Photo by Fraunhofer ISE.



FIGURE 6.41 Double glazing unit with a Polymer dispersed liquid crystal (PDLC) layer that can be switched between a clear, transparent state and a frosted, opaque state. Reprinted from Intelligent Glass website.

Performance

Table 6.10 gives an overview of performance of some switchable window systems. The gasochromic and thermotropic types perform better (e.g. have a broader range in transmittance between normal and tinted state) than most electrochromic types. However, electrochromics are preferred more often in architectural practice because of the low scattering and their ease of operability (e.g. a low voltage is sufficient to switch between different states). Moreover, one issue of hydrogels, as the common thermo-sensitive substance used in thermotropic systems, is its cyclic durability and the inconsistent transparency over the glass layer during the switching process.

	TYPE	WINDOW SYSTEM	STATE	T _{vis}	T _{sol}	SHGC / G-VALUE
1	electrochromic	typical values (Lampert, 2004)	normal state	50% - 70%		0.52 - 0.58
			tinted state	10% - 25%		0.16 - 0.26
2	electrochromic	double pane configuration with argon filling (Sage Electrochromics, 2011)	normal state	62.5%		0.48
			tinted state	3.5%		0.09
3	electrochromic	double pane configuration (James & Bahaj, 2005)	normal state	70%		0.52
			tinted state	4%		0.10
4	electrochromic	double pane configuration (Papaefthimiou et al., 2006)	normal state	50% / 72% / 55%		
			tinted state	15% / 17% / 2%		
5	gasochromic	double pane configuration with 560 nm thick coating (Wittwer et al., 2004)	normal state	77%	0.76	
			tinted state	6%	0.05	
6	thermotropic	CloudGel film between two panes of glass (Lampert, 2004)	normal state (T = 25°C)	79%	63%	
			tinted state (T = 60°C)	4%	3%	

T_{vis}: The percentage of the visible spectrum (380-720 nm) that is transmitted through the glazing.

T_{sol}: The percentage of the total solar radiation that is transmitted through the glazing.

The g-value of #1 is calculated from given values of the Shading Coefficient (SC), the ratio of solar heat gain through glazing compared to standard clear float glass. SC is roughly 1.15 times SHGC (or g-value) which has become the standard.

The gasochromic glazing (#5) turns blue in the tinted state. By applying thicker coatings the colour becomes darker and the light transmittance will be further reduced. Mixing the original coating with other oxides can alter the colour in the tinted state. This will affect the performance in that state as well (Wittwer et al., 2004).

TABLE 6.10 Overview of switchable window systems and their performance.

To increase the thermal performance of switchable window systems their application can be integrated into a window system which includes for example an additional low-e coated layer. The double pane electrochromic glazing unit (#2) has an U_{glass} of 0.28 W/m²K. The double pane gasochromic glazing unit (#5) can be combined with a third low-e coated glass layer which will reduce the U-value of the whole triple-glazing unit to under 1 W/m²K. The significant impact that switchable window system can have on indoor temperature development under the influence of solar irradiation is shown in test results from field measurements conducted with a liquid crystal window system (Figure 6.42).

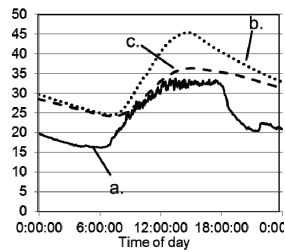

FIGURE 6.42 Measured outdoor temperature (a) and indoor temperature of a reference test cabin (b; g -value: 0.44, T_{vis} : 0.69 and U_{glass} : 1.1 W/m²K) and a test cabin equipped with a liquid crystal window (c). Reprinted from Van Oosten & Zitto (2016).

Process

As mentioned earlier, the employment of daylight systems is determined from an interrelated set of considerations on daylight admittance, glare prevention, solar shading and outside view. When daylight admittance and outside view are important factors and need to be ensured at all times, switchable window systems that only change colour are best suited. Switchable window systems that becomes opaque in the tinted state is applicable in windows where outside view is not important (e.g. skylights, clerestory windows, atrium windows).

Architectural consequences

A switchable window system in its normal, clear state has no visual difference from ordinary glass. This doesn't apply for its tinted, coloured or opaque state. The application of switchable window systems puts constraints on window size - when compared to ordinary glazing - and will therefore result in a patchwork of glazing panels when applied in full glass façades.

§ 6.6.4 Light shelf

Light shelves are architectural elements typically placed above eye-level and split a window in two. The top of the shelf reflects light through the upper part towards the ceiling and deeper into the room. At the same time the lower part receives less natural light. This will result in a more evenly spread natural illumination of the room; bright levels of light directly behind the window are tempered and natural light can penetrate deeper into the room.

The shelf can be placed either at the exterior of the window, at its interior or cut through the window. Light shelves that stick out of the window also function as a shading device, offering to the lower part of the window.

Performance

In a field experiment conducted by Christoffersen et al. (1999) the natural light distribution in a room when adding different types of horizontal light shelves to a window was compared to a reference situation where the window was not equipped with light shelves. Design parameters were the upper finish of the light shelf (matt, white and specular) and its position (internal, external), among others. They found that the level of illumination only increased with an internally placed specular light shelf at clear sky conditions when the sun's altitude was low. At overcast conditions any researched light shelf design reduces illumination levels since it partially blocks views to the sky. Although overall illumination levels dropped, the situation was perceived more comfortable due to the more even distribution, on the condition that a minimal level of illumination is achieved.

In order to reflect natural light towards the ceiling the upper surface of the light shelves needs to be painted white, or be specular when solar heat gain is no issue. To improve the even distribution of light throughout the room the finish of the ceiling is best white-coloured as well.

Process

Light shelf design is part of the window system and therefore bounded by considerations on daylight admittance, glare prevention, solar shading and outside view. When the shelf position is lowered more light will be reflected into the building through the upper window. At the same time the lower window becomes smaller and reduces the window area available for views outside. The clear view on the sky through the enlarged top window can also cause issues of glare. This can be eliminated by extending the light shelf towards the interior. When solar shading is necessary the light shelf may be extended towards the outdoors.

Architectural consequences

A light shelf is a visible item in any design configuration. It can be designed as a distinct aesthetical element, both for to the interior and the exterior of the building (Figure 6.43). Light shelves lend themselves to renovation projects on the condition of high windows where the shelf can be positioned above eye-level. Otherwise the reflective top may cause issues of glare.



FIGURE 6.43 Light shelves allow natural light to penetrate deeper into the room and reduces bright light levels directly near the window. The light shelves are placed inside the façade to keep the reflective top cover clean (and thus more reflective). The shelves still are pushed to the outside to catch more light, poking the building envelope outwards. Amgen office building, Breda by Ector Hoogstad architects. Photo by Marcel van Kerckhoven.

§ 6.7 Solar shading

Solar shading is primarily about the exclusion of undesired solar radiation through transparent openings at those times that air temperatures are already high. Shading devices come in many different variations (Figure 6.44) and can be categorised in different ways. With respect to shading element position three generic types can be distinguished: exterior elements, glazing embedded systems and interior elements. A second categorisation regards the control or adaptability of the shading. It can either be fixed (i.e. not able to change position or state during occupation)²⁷ or adaptable (i.e. able to alter position or state during occupation). The adaptable behaviour can relate to movability (e.g. folding, retractable or mobile shading devices) or changeability of optical properties of the glazing (switchable window system, section 6.6.3). A special type of fixed shading is from structural elements that provide shade for other parts of the building.

27

A special type of adaptable behaviour can be (seasonally) gained from (on-site) vegetation (e.g. plants, trees and bushes). Strategic placement of a building with respect to existing vegetation or the use of planted vegetation can offer time-dependent solar shading. When using winter-proof vegetation shading is provided throughout the year while deciduous vegetation provides best shading more in phase with the need for cooling in summer.

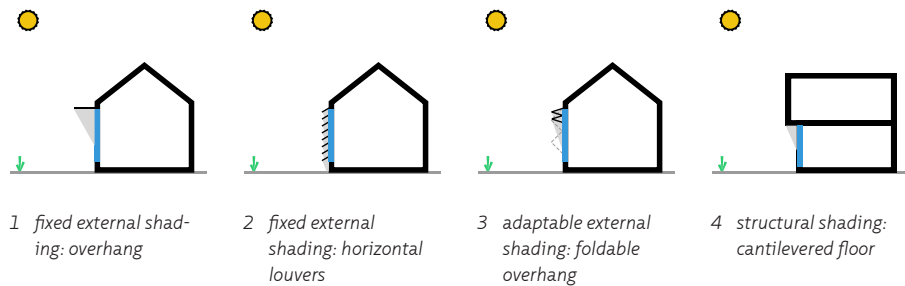

FIGURE 6.44 Various examples of shading.

Performance

When it comes to a cooling strategy, exterior sun shading devices perform best in keeping the heat out. This is illustrated in Figure 6.45 where the performance of a window system with identical venetian blinds is compared for three different positions of the blinds. Most relevant in a cooling strategy are the g-value and the convection factor (CF), the convective part of the transmitted energy that will result in an immediate increase of indoor temperature. The g-value of the setup with external shading is significantly lower and the convection factor (CF) is almost zero, when compared to positioning the blinds inter-pane or the interior.

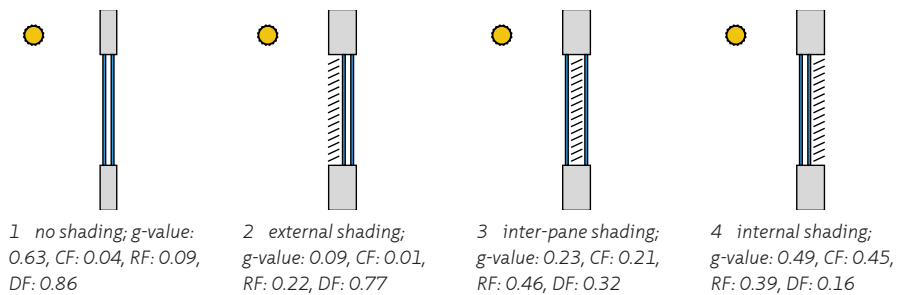

FIGURE 6.45 The influence of the position of a solar shading setup using venetian blinds (at angle of 65°) on the g-value of the window system (after Beck, 2010). CF is convective fraction; RF is radiative fraction; DF is direct fraction.

Process

When designing shades, both site location and orientation of windows need to be considered with respect to heating and cooling demands. Since any shading device has an effect on received levels of daylight, this should also be part of consideration during design, together with the aspect of outside view.

Furthermore, shading may not interfere with a passive heating strategy where solar heat is harvested through those same transparent openings that are shaded in summer. The distinct sun path in summer and winter makes that fixed architectural elements can be employed to suffice both strategies (Olgyay & Olgyay, 1976). Careful design is crucial. Especially with structural shading devices since they cannot be easily altered after construction.

Shading devices need to be designed in such a way that solar radiation is blocked only at those times of year when overheating is of concern. This goes beyond an often used simplified solar shading strategy based on the design of fixed shading elements that provide full shade from the highest sun angles. As can be seen in chapter 4 peak ambient temperatures in the Netherlands do not coincide with the highest sun angles but occur with a phase shift of approximately 2 months. So, a much desired fixed shading device designed for sun angles experienced at the 21st of August also provide the same shade around the 21st of April, where direct solar gains are more welcome since ambient temperatures are much lower than in August. This field of tension can be overcome by using adaptable shades or complementing fixed shading by the use of deciduous vegetation that is bare before summer and becomes very leafy during summer.

Architectural consequences

Shading devices come in different forms and when positioned at the exterior of the building, such devices can be considered as an iconic architectural feature. Typical exterior shading devices are overhangs, louvers, curtains, among others that can either be fixed or movable after being mounted to the building (Figure 6.46, Figure 6.47). Light shelves (section 6.6.4) also act as solar shading when they are placed externally.



FIGURE 6.46 Folding shading device that forms an overhang; Villa Röhling, Kudelstaart, the Netherlands by Paul de Ruiter. Photo by Pieter Kers.



FIGURE 6.47 Fixed iconic shading elements; Esplanade, Singapore by DP Architects.

Glazing embedded shading can be realised as an after-treatment to standard glazing or as a whole new glazing typology. The after-treatment of standard glazing can be directly processed into the glazing (e.g. enamelled glazing) or attached to the glazing in a non-permanent way with for instance stickers (Figure 6.48, Figure 6.49).



FIGURE 6.48 Printed horizontal lamellas; Stuttgart Museum of Art, Stuttgart, Germany by Hascher Jehle Architektur. Reprinted from Hascher Jehle Architektur website.



FIGURE 6.49 Tree-shape sticker; Tattoo House, Adelaide, Australia by Austin Maynard architects. Photo by Peter Bennetts.

Interior shading devices include louvers, blinds and curtains. Their ability to keep heat out is limited when compared to external shading since, due to their position at the inside of the window, heat radiation is already admitted into the building. Furthermore, within housing developments the selection of interior shading is often left to the occupant and not the architect.

Structural elements such as balconies, canopies, cantilevered floors, setback windows and sloped façades can provide shade to other parts of the building. Such shading elements are grouped as structural shading devices and can be considered as distinct architectural features (Figure 6.50, Figure 6.51). They perform similar to more common external static shading devices such as overhangs, louvres or screens, except that they can not or not easily be altered after construction. Therefore careful planning during the design phase is essential.

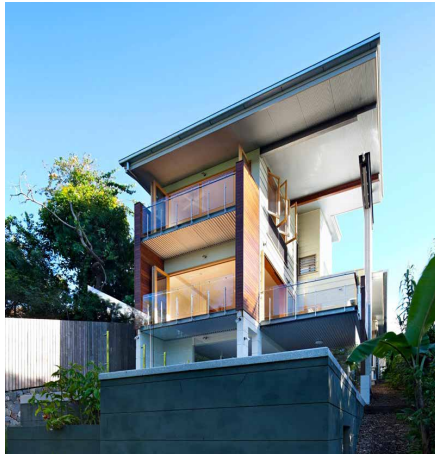

FIGURE 6.50 Shade from canopy and balconies; Hill End Ecohouse, Hill End, Brisbane, Australia by Riddel Architecture. Photo by Christopher Frederik Jones.



FIGURE 6.51 Each cantilevered storey acts as an overhang for the windows of the storey below; London Town Hall, London, United Kingdom by Norman Foster. Photo by Steve Cadman.

§ 6.8 Natural ventilation

Ventilation is primarily about the provision of a healthy indoor air quality by the introduction of fresh air to the building, and simultaneously the removal of stale air. Air flow is induced due to differences in pressure. This can be achieved mechanically by using fans or naturally by employing air pressure differences that are the result of either a temperature difference (thermal-driven or stack ventilation) or from wind flowing around the building (wind-driven or cross ventilation) (Figure 6.52).

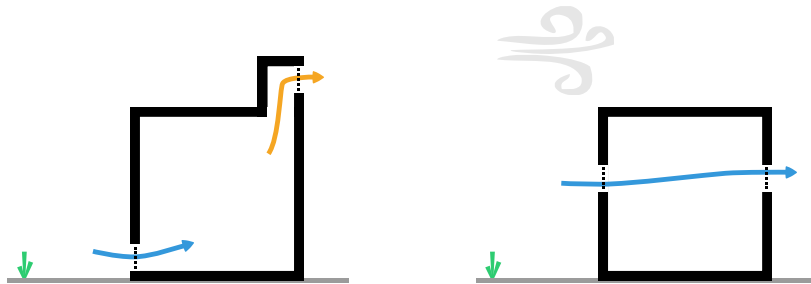

1 Thermal-driven or stack ventilation.

2 Wind-driven or cross ventilation.

FIGURE 6.52 Natural ventilation

In practice both effects mostly occur simultaneously. The efficiency of natural ventilation depends on building geometry, resistance against unobstructed air flows, placement and characteristics of openings and the characteristics of the environment (e.g. climate, urban setting, etc.), among others (Allard & Ghiaus, 2005; Brown & DeKay, 2001). Both ways of natural ventilation can be enforced and thus used more effectively with aid of architectural solutions.

Stack ventilation is enforced by an increased height and temperature difference between the air intake and outlet. A so-called solar chimney (section 6.8.1) employs the concept of solar driven ventilation where the temperature gradient that causes the stack effect is enforced by solar radiation. Stale air can then be removed from a building on sunny, windless days without mechanical installations.

To profit from natural ventilation from wind forces the building skin needs to have good access to wind. In typical residential neighbourhoods characterised by a relatively compact built environment with repetitive low-rise buildings, the wind has a tendency to flow over the array of buildings. With aid of a wind chimney (section 6.8.2) the more undisturbed wind flows above the urban canopy layer can be harvested and put to use for ventilation purposes.

Alternatively, the concept of ventilation can also be employed to passively cool down a building.

§ 6.8.1 Solar chimney

A solar chimney promotes natural ventilation from thermal currents. It enforces the natural stack effect by using solar radiation to heat up the air in a chimney, forcing the air to move upwards. When the air is able to exhaust from the chimney through a vent in the top the resulting air flow will draw air into the chimney from lower placed vents. By placing openings strategically in the building skin fresh air is drawn into a zone and is forced to flow into the chimney, ventilating the zone.

A solar chimney differs from ordinary chimneys because the solar-facing side of the chimney is designed to harvest solar radiation, typically by using glazing and a layer of insulation at the back wall (Figure 6.53). Except for the insulation layer, this part of the solar chimney is constructed similar to the Trombe wall.

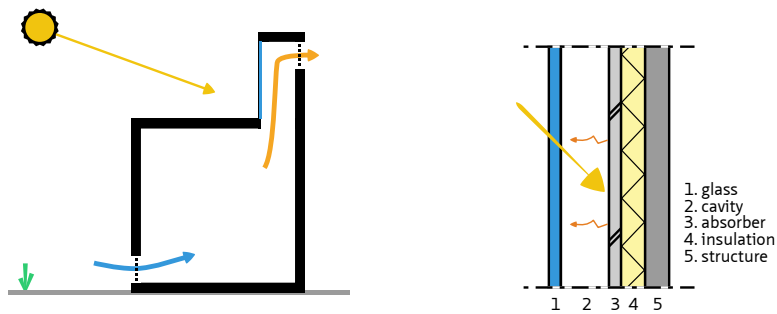

FIGURE 6.53 The principle of a solar chimney (left) and a typical cross-section of that part of the solar chimney that is exposed to solar radiation (right).

Performance

Afonso and Oliviera (2000) conducted field experiments and additional simulations for a small-scale solar chimney design situated in Lisbon, Portugal (38° N). The research focussed on using the solar chimney for natural ventilation purposes and considers the effects of two relatively cool days in January and March (average T_{amb} 6.4°C and 13.0°C). The calculated contribution of solar radiation to the stack effect in the chimney was 10.2% in January and 22.4% in March, whereas the actual average flow rate in the chimney is higher in January due to a lower ambient temperature.

Afonso and Oliviera (2000) also studied the effect of storage wall thickness and insulation. They found that the thickness of the storage wall hardly affects the average flow rate in the channel but does affect the amplitude of the diurnal air flow rate. Thicker walls have a smaller amplitude meaning that air flow rates are higher during the night and lower during the day when compared to thinner walls. The difference in storage capacity means that thin walls are therefore most beneficial during the day while thick walls increase the chimney effect during the night. The importance of the insulation layer is validated by simulation outcomes that revealed a 60% drop in solar contribution when no insulation was applied compared to an adiabatic setup. Only 5 cm of insulation proved to be sufficient to approximate the ideal situation. They also found that chimney performance improves with higher chimneys and concluded that an increase in chimney width is more effective than chimney height when it comes to increasing air flow rates.

Harris and Helwig (2007) studied the optimum configuration (i.e. dimensions and materialisation) and inclination angle²⁸ of rooftop solar chimneys on a summer day in Edinburgh, Scotland (52° N), as measured by the airflow rate through the chimney for cooling purposes. A slope of 67.5° from the horizontal is found to be the optimum for the considered local climate and generates 11% more airflow than a vertical chimney.

In Bronsema (2013) the performance - in terms of potential for both natural ventilation and passive solar heating - of solar chimneys for office buildings was researched for the Dutch context. The efficiency of the chimney - in terms of passive solar design - is predominantly determined by the choice for glazing (high g-value, low U-value) and improved by using a low thermal mass absorber wall. South-facing solar chimneys perform best, although multi-orientation chimneys show a more evenly spread in the stack effect during the day. Furthermore, the performance is quite rightly determined with the width of the chimney.

Process

The employment of solar-driven ventilation requires careful planning, since ventilation will also be needed after sunset. The use of heat absorption techniques within the chimney structure will elongate the effect of the solar chimney. In order to achieve a year-round ventilation solution, the concept of solar-driven ventilation is best combined with other techniques based on the principle of wind-driven ventilation (Bronsema 2013). In some cases it might even be necessary to develop a hybrid system where a mechanical system complements the solar chimney.

When a solar chimney has a direct contact with a comfort zone, sufficient insulation of the chimney's back wall is of importance to eliminate undesired heat flow from the chimney to the building. Furthermore, when the driving force within the chimney ceases a possible counter flow of air due to downdraught needs to be prevented.

Architectural consequences

To make sure that all zones profit from the solar enforced stack effect the sun faced chimney needs to exceed the upper most floor that needs to be ventilated, typically above roof level. Such solar chimneys have a distinctive visual appearance that may then be seen as an aesthetical design feature. When using existing open staircases that have little obstructions, solar chimneys are applicable in renovation projects (Figure 6.54). However, special attention is needed to restrain temperatures and drafts that cause discomfort.

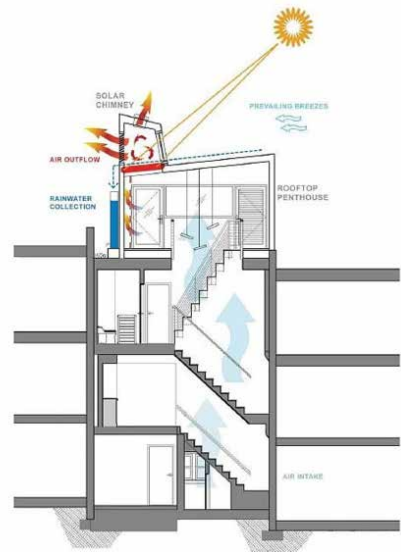

FIGURE 6.54 An added rooftop pavilion provides extra space in a renovation project. The pavilion is equipped with a small chimney. Solar radiation that enters the chimney chamber through a window is absorbed by a dark surface finish and quickly heats the chamber. The hot air can escape from a small vent at the top of the chimney causing cooler air to be taken in from lower placed shaded areas. Meridian View House, Washington, United States by iSTUDIO architects. Reprinted from iSTUDIO architects website.

Alternatively, the chimney can also be merged into the façade or sloped roof structure (Figure 6.55). By doing so you still benefit from solar induced thermal stack without a visually notable chimney. Merging the chimney in the façade or roof structure will elongate the channel of the chimney and thus increase performance.

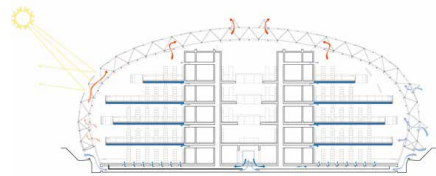

FIGURE 6.55 The double layer of the dome provides solar-induced natural ventilation; Philology Library, Berlin by Norman Foster. Reprinted from Foster + Partners website.

§ 6.8.2 Wind chimney

Wind chimneys are chimney-like elements that tower above roof level and are able to catch the more undisturbed wind flows. Wind chimneys can be employed as a wind catcher (Figure 6.56) that allows fresh air in directly, following the principle of cross ventilation, when the opening in the chimney is pointed towards the direction of the wind. Alternatively, wind chimneys can be utilised as an exhaust chimney when passing wind flows create a slight under pressure in the chimney, causing air to be drawn out from the building (Figure 6.57). A single chimney with two openings in opposite directions can be used to both take fresh air in and stale air out using a single structure (Figure 6.58). Wind chimneys with an opening fixed to a certain orientation only work with unidirectional wind flows. To increase the effectiveness of a wind catcher or exhaust chimney throughout the year a wind cowl can be put on top that has the ability to turn in the wind. The system then becomes universally applicable, independent from the wind direction. The air flow in an exhaust chimney can be enforced by adding a certain roof shape over the chimney that forces wind flows to speed up when passing over the chimney due to the Venturi-effect (Figure 6.59).

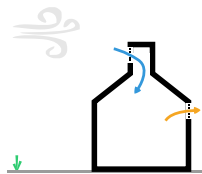

FIGURE 6.56 A wind catcher has an opening facing the wind allowing ventilation air to enter the building.

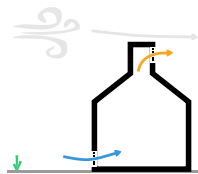

FIGURE 6.57 With an exhaust chimney passing air flows cause a lower pressure in the chimney that triggers an exhaust flow of stale air.

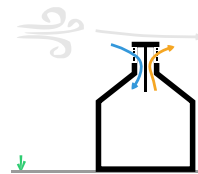

FIGURE 6.58 A wind chimney with double openings can be used to both allow fresh air in and stale air out using a single chimney.

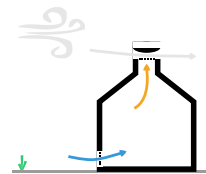

FIGURE 6.59 Enforced wind speed over an exhaust chimney as the result of the Venturi-effect caused by the added roof shape.

Performance

A study into whole building ventilation under real weather conditions was conducted for a typical wind cowl system on top of a three-storey building (Dunster et al., 2008). The used weather data set for Gatwick, United Kingdom shows an average wind speed of 3.2 m/s. The plot of the air change rate throughout the year shows an air change rate between 0.5 and 1.0 per hour during many parts of the year with a lower rate in summer periods.²⁹ This can be explained from a reduced contribution of the stack effect due to higher outdoor temperatures and lower wind speeds. Complementary field measurements on the effectiveness of the wind cowl system showed that required minimal ventilation air change rates (0.3 dm³/s per m² according to UK building regulations in 2006) are achievable at low wind conditions. By simply increasing the size of the air inlet and outlet higher ventilation rates are possible.

Process

The exploration of expected local wind patterns is the primary step to decide what kind of wind chimney is applicable. When wind blows from a clear predominant direction (i.e. southwest in the Netherlands, section 4.2.3) a wind catcher or exhaust with a single opening will do. When there is no clear predominant wind direction or when you want to increase the effectiveness of the system, multiple openings or a rotary version may be the better solution.

The next step is to determine the size of the openings. This depends on the average wind speed and the minimal required ventilation rate. The larger the opening, the more air can be transported at certain wind speeds.

Architectural consequences

In order to boost the effectiveness of a wind catcher at low wind speeds, the openings need to be relatively big. Therefore wind chimneys become highly visible and can be designed as a specific architectural feature (Figure 6.60).



FIGURE 6.60 Rotating wind cowl that draws fresh air in and removes stale air at the same time. The system is equipped with a heat exchanger unit; BedZed, Hackbridge, London, United Kingdom by Bill Dunster. Photo by Tom Chance. Copyright: BioRegional.

§ 6.9 Showcase of combined design solutions

The previous section of this chapter has given an overview of different climate-responsive building elements. These architectural elements have been discussed on the basis of the primary underlying design principle. Many of the discussed design principles and solutions lend themselves for collaboration. Here, some combined solutions are presented briefly. Their presentation is for illustration purposes only and the shown solutions are selected arbitrarily.

Adaptable insulation and thermal storage wall

Prototypes of switchable thermal insulation (STI, section 6.2.1) that have been developed so far are considered integrated into thermal storage walls (section 6.4.2, [Figure 6.61](#)) (ZAE-Bayern, 2011). In summer the STI is in a resistive state preventing the storage wall to be heated by the sun. In winter the STI switches to a conductive state and solar energy is harvested for space heating purposes.

Different dynamic building simulations using climate data for Würzburg, Germany were conducted to calculate the performance (Horn et al., 2000; Meister et al., 1999). These studies showed an increased solar heat gain of the thermal storage wall between 140 kWh/m² and 200 kWh/m² during the heating season, depending on the configuration of the thermal storage wall and the used control strategy.

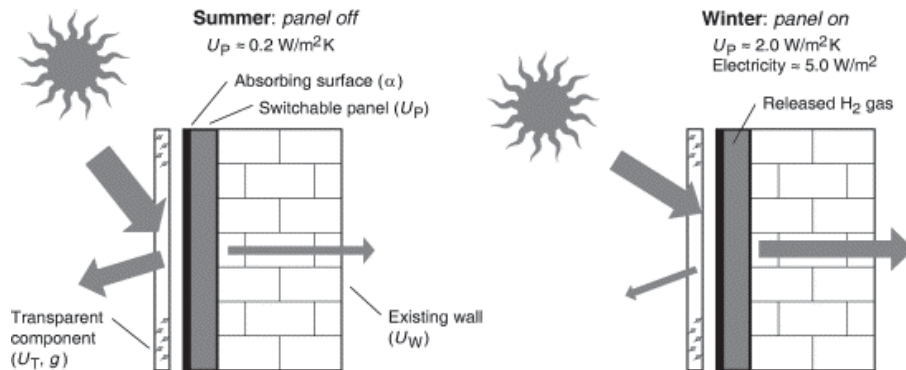

FIGURE 6.61 Summer and winter operation of switchable thermal insulation (STI) embedded in a thermal storage wall setup. The mentioned U-values are valid for a 2 cm thick panel consisting of compressed glass fibre encased in a stainless steel container. Reprinted from Lindenberger et al. (2004).

Thermal shutters as solar shading

The function of a thermal shutter can be extended to that of a solar shading device. Different techniques exist to integrate solar shading functionality in a thermal shutter. When the shutter is designed as a louvre that can be shut³⁰ (Figure 6.62) or when it can fold open and become an overhang (Figure 6.63) the setup still allows outside views and daylight admission. The foldable shutter can be positioned above the window to block high solar angles in summer or fold open to the side of the window to block low sun angles in the morning or the evening (Figure 6.64). The thermal shutter can also be equipped with a translucent insulation material which guarantees a certain heat resistance while still allowing diffuse light to enter the building. Such shutters can also be placed in front of the window at cold winter days without excluding all natural light.

30

Concept similar to Skyliid self-operating insulated louvers by Zomeworks as developed in the 1970's [www.zomeworks.com].

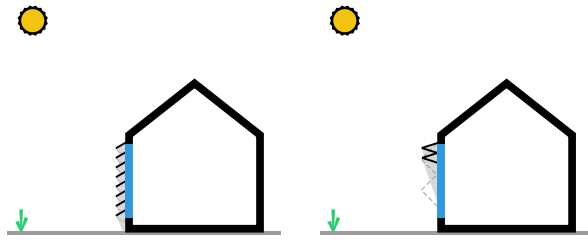

FIGURE 6.62 Louvred shading device that can be closed and function as a thermal shutter.

FIGURE 6.63 Foldable thermal shutter that folds open to form a shading device at the top of the window.



FIGURE 6.64 Externally hinged thermal shutters that function as a shading device. Municipality office in Bronckhorst, the Netherlands by Atelier Pro. Reprinted from Atelier Pro website.

Translucent insulation with water drums to store heat

As mentioned before, the high specific heat capacity of water gives it great potential for heat storage purposes (Table 6.5, section 6.3.1). Furthermore, thermal mass systems using water over massive (building) materials have the ability of being embedded in transparent containers that still allow natural light to enter the building (Figure 6.65).



FIGURE 6.65 Translucent thermal storage wall of the Solar Decathlon House 1 of Ohio State University. This thermal storage wall is constructed from two translucent plates of polycarbonate holding water-filled acrylic tubes in-between. This configuration allows sufficient natural light to enter the bathroom and still maintains privacy. Reprinted from Ohio State University website.



Window system with prismatic elements and embedded PCM

A translucent insulation system can also be extended with light-redirecting behaviour that enables the capacity of an integrated thermal storage wall at certain sun angles. Such a window system was specially designed for the Alterswohnen housing project (Figure 6.66). The 8 cm thick quadruple layered window system has a U-value of 0.48 W/m²K. The outermost cavity is equipped with prismatic elements that block sun angles higher than 40° and transmit the radiation at lower angles. The innermost cavity is equipped with a phase change material (PCM) that absorbs the transmitted light and re-radiates the heat with a delay into the room (Figure 6.67). As a result the peak indoor temperature is shifted with three hours. The window system has an estimated heat demand reduction of 80-180 kWh/m² per year, depending on the building design (Horschig et al., 2007). The shape of the prismatic elements is customisable and determines at which sun angles radiation is reflected or transmitted.



FIGURE 6.66 Translucent window system with thermal buffering capacity from prismatic elements and embedded PCM. Alterswohnen in Domat/EMS, Switzerland by Schwarz Architekten. Adapted from Swiss Solar Agency (2006).

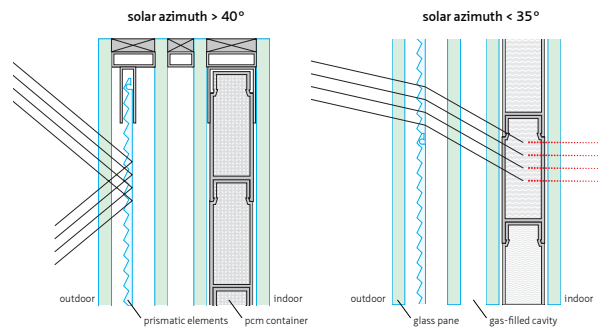

FIGURE 6.67 Schematic representation of window system in summer mode when the sun's azimuth is over 40° (left) and in winter mode when the azimuth is below 35° (right). In summer mode the direct solar radiation that strikes the window is reflected by the prismatic elements. In winter mode, when the solar radiation strikes the window at a lower angle, the sun's rays pass the prismatic elements and is then absorbed by the container with PCM. The stored heat is with a delay delivered to the room. Adapted from Swiss Solar Agency (2006).

§ 6.10 Guidelines during the concept development phase

In section 5.5 the following content requirements for the design support tool were defined:

- Comfort contribution and energy performance
- Identification of collaborations and conflicts when using multiple design principles together
- Possible energy function of climate-responsive building elements and their primary (or other) function
- Impact of climate-responsive building elements on the appearance of design

In the previous sections of this chapter this information was generated for a selection of climate-responsive building elements as presented in [Table 5.8](#). This section provides a resumé of the gathered knowledge on the four denominated content requirements, that form a substantial part of the content for the support tool, as described in the next chapter 7.

Comfort contribution and energy performance

In the previous sections of this chapter the comfort contribution and energy performance of many climate-responsive building elements was researched. Whenever this contribution or performance was quantified it shows a potential of that contribution or performance. In other words, it gives an indication of what can be achieved and does not state absolute or guaranteed values. These quantifications are very likely to be specific for the used design options and can not be easily compared to one another for the purpose of selecting design solutions based on their contribution or performance. Moreover, conditions and restrictions apply to the presented quantification and may result in misinterpretations if not communicated well enough. Providing meaningful indications of comfort contribution and energy performance for climate-responsive design solutions is considered beyond the scope of this research, mainly because of its time-consuming and complex nature. There is no value in bringing the researched comfort contribution and energy performance in the sections 6.2 to 6.8 here in a resumé.

Identification of collaborations and conflicts when using multiple design principles together

Most principles will operate next to each other without interfering with their individual performance, but some combinations require special attention in the design process in order to prevent conflicts in the final design which can reduce overall performance significantly. Next to possible conflicts, climate-responsive principles also have great opportunity of improved overall performance through collaboration. One of the challenges of concept development is to exploit these synergetic effects and overcome conflicts through creative solutions.

In order to combine and integrate complementing design principles into a single design it should be clear what the boundary conditions are for each individual design principle to operate as intended. Furthermore, it is essential to provide insight into the opportunities one principle has to be improved or complemented which can be realised through collaboration, and to give insight into the threats that can lead to possible conflicts when different principles are combined.

Conflicting effects

Conflicting aims are inevitable in a highly complex design process. Any design decision made can affect future decisions to be made in the process. It may exclude other design solutions or reduce their performance when not addressed correctly. For instance, compact and stacked building design reduces the area of the building envelope that is exposed to the outdoor environment. This can be beneficial in harsh conditions where the envelope primarily operates as a shelter but will also reduce the possibility of interaction with the outdoor environment at times when valuable energy can be harvested. The key is to be aware of the possible conflicts in an early stage in order to come up with creative solutions to gain in overall performance of the design. Possible conflicts, drawn from the work in the previous sections, are listed in [Table 6.11](#).

POSSIBLE CONFLICTS	EXPLANATION / CLARIFICATION	DESIGN CONSIDERATIONS
Flexibility of layout vs. thermal zoning	A flexible layout leaves the planning of the dwelling to the occupant. This implies that all zones need to be able to fulfil a variety of comfort demands, including the one's with the highest standard. Opposed to a thermal zoning concept where it should be clear to the occupant if a zone is meant to fulfil a specific purpose in the energy concept that makes it not eligible for flexible use (e.g. a sun space that is transformed into an all-year round living space and therefore reduces overall performance).	-
Compact design vs. daylight admission and natural ventilation potential	Compact building design is highly functional while routing stays minimal and highly efficient from a thermal conservation point of view. However, compact design may conflict with sufficient daylight admission and the potential of using natural ventilation techniques.	- Use skylights to improve the quality of natural light into the building. Harvest undisturbed wind flows that pass over the building roof.
Flexibility of layout vs. strategies for natural ventilation and passive cooling	Natural ventilation and passive cooling strategies require a matching layout. The flexibility of the layout should be taken into account in order to prevent the need for technical installations when building use changes.	- Natural ventilation flows benefit from unobstructed paths and are enforced by sufficient height differences.
Thermal buffering vs. natural illumination	Massive building elements to improve the building's thermal quality by buffering energy may interfere with desired levels of transparency for daylight admission and views to the outside.	- Adopt floor structures and/or interior wall elements for thermal mass. - Choose PCM as an alternative.
Natural illumination vs. solar shading	Careful design of measures that guarantee daylight admission and outside view in compliance with solar shading, glare protection and privacy issues.	- Use solutions that are able to meet multiple requirements. These solutions can be either non-adaptable such as light shelves or adaptable in the form of movable or foldable sun shades, or louvres.
Active solar design vs. passive solar design	A ray of sunlight can typically only be used once. Smart selection optimises both active solar gains (e.g. photovoltaics or thermal collectors) and passive solar gains (e.g. passive solar heating, natural illumination).	- Deploy both active and passive solar design strategies close(r) to comfort demands to be met (e.g. solar hot water in the morning, solar power after works hours, etc.).

TABLE 6.11 An overview of possible conflicts in the development of the climate-responsive design concept.

Synergetic effects

Different design principles and solutions have great potential to boost individual and thus overall performance when they collaborate on the condition that their application is geared to one another. For instance the design of solar shading devices that can be placed in front of a window and function as an additional thermal insulation layer. Unlocking this potential is essential to reach high performance when employing natural energy flows to supply comfort. Synergetic effects, drawn from the previous chapters are listed in [Table 6.12](#).

DESIGN PRINCIPLE THAT HAS AN OPPORTUNITY TO COLLABORATE	EXPLANATION AND CONSIDERATIONS
passive solar heating and thermal energy storage	– The overcapacity of 'over-sized' (i.e. generating more energy than directly required) passive solar heating solutions can be stored for later use.
passive solar heating and thermal buffering	– The overcapacity of 'over-sized' (i.e. generating more energy than directly required) passive solar heating solutions can be buffered for use after the sun sets and ambient temperatures may drop significantly.
passive solar heating and solar driven ventilation	– Trombe wall systems where air filled cavities are heated by solar radiation can be partially employed as solar chimney.
solar shading and thermal conservation	– When solar shading devices are designed in such a way that they can be placed in front of a window, they can function as additional thermal insulation when needed.
solar shading and solar power	– Since a shading device's primary task is to prevent windows to be exposed to solar radiation, they can be equipped with photovoltaic cells to harvest solar energy instead of rejecting it.
natural ventilation and earth coupling	– In colder periods when ventilation air drawn directly from outside could cause issues of draught. To prevent this, a solar or wind-driven ventilation system can be connected to a ground-coupled ventilation system that preconditions the fresh ventilation air.
solar driven ventilation and natural air cooling	– The need for cooling follows the solar offer to a large degree. Solar-driven ventilation flows can therefore be applied to draw cool air in for passive cooling purposes.

TABLE 6.12 An overview of opportunities for collaboration between climate-responsive design principles.

Possible energy function of climate-responsive building elements and their primary (or other) function

The selection of design elements should aim for their contribution to the energy concept next to fulfilling primary functions such as safety and functionality. For instance, a construction pile could function as a vertical ground-coupled heat exchanger, next to its primary function as building support. Another example is the employment of attic space to collect solar radiation or trap valuable heat that rises from the lower storeys of the building. Table 6.13 gives an overview of the hidden energy purpose of building components, supplementary to their primary function(s).

COMPONENT	PRIMARY FUNCTION(S)	HIDDEN ENERGY PURPOSE(S)
building site	<ul style="list-style-type: none"> - accessibility - outdoor space 	<ul style="list-style-type: none"> - improvement of microclimate through vegetation and water bodies - shading from vegetation - wind protection
staircase	<ul style="list-style-type: none"> - internal routing 	<ul style="list-style-type: none"> - increase height difference to enforce natural ventilation potential
hallways	<ul style="list-style-type: none"> - internal routing 	<ul style="list-style-type: none"> - thermal distribution - thermal buffer zone
attic	<ul style="list-style-type: none"> - storage space - additional living space 	<ul style="list-style-type: none"> - solar collection - internal heat collector (from rising warm air)
construction pile	<ul style="list-style-type: none"> - building support 	<ul style="list-style-type: none"> - earth coupling
ground floor slab	<ul style="list-style-type: none"> - building support 	<ul style="list-style-type: none"> - thermal mass - direct earth coupling
basement	<ul style="list-style-type: none"> - utility and storage space 	<ul style="list-style-type: none"> - energy storage facility
load bearing wall	<ul style="list-style-type: none"> - building support 	<ul style="list-style-type: none"> - thermal mass - thermo-activation
column	<ul style="list-style-type: none"> - building support 	<ul style="list-style-type: none"> - thermo-activation
beam	<ul style="list-style-type: none"> - building support 	<ul style="list-style-type: none"> - thermo-activation
floor	<ul style="list-style-type: none"> - building support - internal organization of spaces - storey separation - fire protection 	<ul style="list-style-type: none"> - thermal mass - thermo-activation
external wall	<ul style="list-style-type: none"> - shelter 	<ul style="list-style-type: none"> - microclimate improvement from green walls - thermal conservation
window	<ul style="list-style-type: none"> - daylight admission - natural ventilation - outdoor view 	<ul style="list-style-type: none"> - thermal conservation - direct solar heating
roof	<ul style="list-style-type: none"> - shelter - rainwater drainage 	<ul style="list-style-type: none"> - microclimate improvement from green roofs - thermal conservation - roof pond - solar attic
internal wall	<ul style="list-style-type: none"> - internal organization of spaces - room separation - fire protection 	<ul style="list-style-type: none"> - thermal mass
ceiling	<ul style="list-style-type: none"> - aesthetical feature 	<ul style="list-style-type: none"> - surface characteristics for optimization of daylight, thermal mass and acoustics
floor covering	<ul style="list-style-type: none"> - aesthetical feature 	<ul style="list-style-type: none"> - surface characteristics for optimization of daylight, thermal mass and acoustics

TABLE 6.13 An overview of the hidden energy purpose of building components, supplementary to their primary function(s).

In most cases the energy function of an element will not interfere with its primary or other function(s). Still, a possible negative influence on the primary function when employing the energy function to its full potential is a point of concern. For example, in section 6.5.3 it was mentioned that when too much heat is extracted from the ground when using energy piles - construction piles with integrated heat exchanger - the construction pile may lose its bearing capacity due to frost.

Impact of climate-responsive building elements on the appearance of design

Many climate-responsive building elements don't typically show as such, meaning that they don't have a distinguished visual appearance where they differ from 'ordinary' elements. Take for example the energy pile. Unlike other climate-responsive building elements that can not be 'hidden' in the design. Take for example the concept of earth sheltering. Some elements can be made visible or rather not and still perform as desired. Such elements, for example the solar chimney, can be employed by the architect to create distinguished architectural designs. Table 6.14 gives an overview of the (in)visibility of the element in design.

DESIGN PRINCIPLES	DESIGN SOLUTIONS	IMPACT ON APPEARANCE OF DESIGN	
		visible	invisible
thermal conservation	adaptable insulation	✓	✓
	thermal shutter	✓	
	translucent insulation	✓	
	dynamic insulation		✓
thermal buffering + thermal distribution	thermal mass		✓
	thermo-activated building elements		✓
	cavity wall heating		✓
	ventilated hollow core elements		✓
passive solar heating	direct solar gain		✓
	thermal storage wall	✓	
	sun space	✓	✓
	roof pond	✓	✓
earth-coupling	direct-contact foundation slab		✓
	earth shelter	✓	
	energy piles		✓
natural illumination	light-redirecting window systems	✓	
	switchable window systems	✓	
	light shelf	✓	
natural ventilation	solar chimney	✓	✓
	wind catcher	✓	
solar shading	structural overhang	✓	

TABLE 6.14 An overview of the visual impact of climate-responsive elements on the design. visible elements are clearly distinguishable and can, if desired, be designed as an architectural feature, whereas 'invisible' elements don't appear different from the 'ordinary' building elements.

§ 6.11 Conclusion

In this chapter additional knowledge is gathered for climate-responsive design solutions on the aspects of performance, process and architectural consequences, discussed according to the main design principle they are based on (section 6.2. to 6.8). Since many design principles and solutions are suitable for collaboration, some of the combined solutions are briefly presented in section 6.9. The in-depth discussion of the design solutions and the brief discussion of combined solutions in this chapter give a comprehensive, but not necessarily complete overview of climate-responsive design solutions. In section 6.10 the findings were collected in a resumé with the enumeration of design guidelines for the phase of energy concept development.

In the next chapter, a framework will be presented for a design-decision support tool that aims to assist architects in making informed decisions during the development of the energy concept of a design, as part of the early stages of the design process. Starting from the definition of the tool's requirements, the results from this chapter together with the findings of chapters 3 and 4 are incorporated in a concept tool.

References

- Afonso, C. and Oliveira, A. (2000) Solar chimneys: simulation and experiment in *Energy and Buildings* 32-1, pp. 71-79.
- Allard, F. and Ghiaus, C. (2005) *Natural ventilation in the urban environment – assessment and design*. London, England: Earthscan.
- Anselm, A.J. (2008) Passive annual heat storage principles in earth sheltered housing, a supplementary energy saving system in residential housing in *Energy and Buildings* 40, pp. 1214–1219.
- Artmann, N., Manz, H. and Heiselberg, P. (2008) Parameter study on performance of building cooling by night-time ventilation in *Renewable Energy* 33, pp. 2589–2598.
- Aschehoug, Ø. and Perino, M. (2009) IEA ECBCS Annex 44 Integrating Environmentally Responsive Elements in Buildings - Expert Guide - Part 2 Responsive Building Elements. Retrieved from http://www.ecbcs.org/docs/Annex_44_Expert_Guide_RBE.pdf
- Babiak, J., Minářová, M. and Olesen, B.W. (2007a) What is the effective thickness of a thermally activated concrete slab? in proceedings of the REHVA's 9th World Congress Clima 2007, Helsinki, Finland.
- Babiak, J., Olesen, B.W. and Petráš, D. (2007b) Low temperature heating and high temperature cooling, Embedded water based surface systems (REHVA guidebook no. 7). Brussels, Belgium: REHVA.
- Baetens, R., Jelle, B.P., Thue, J.V., Tenpierik, M.J., Grynning, S., Uvsløkk, S. and Gustavsen, A. (2010a) Vacuum insulation panels for building applications: a review and beyond in *Energy and Buildings* 42-2, pp. 147-172.
- Baetens, R., Jelle, B.P. and Gustavsen, A. (2010b) Phase change materials for building applications: a state-of-the-art review in *Energy and Buildings* 42-9, pp. 1361-1368.
- Baetens, R., Jelle, B.P., Gustavsen, A. and Grynning, S. (2010c) Gas-filled panels for building applications: a state-of-the-art review in *Energy and Buildings* 42-11, pp. 1969-1975.
- Baetens, R., Jelle, B.P. and Gustavsen, A. (2011) Aerogel insulation for building applications: a state-of-the-art review in *Energy and Buildings* 43-4, pp. 761-769.
- Baker, P.H. (2003) The thermal performance of a prototype dynamically insulated wall in *Building Services Engineering Research and Technology*, vol. 24, issue 1, pp. 25-34.
- Barton, P., Beggs, C.B. and Sleight, P.A. (2002) A theoretical study of the thermal performance of the ThermoDeck hollow core slab system in *Applied Thermal Engineering* 22, pp. 1485–1499.
- Beck, W. (2010) Solar shading - How to integrate solar shading in sustainable buildings (REHVA guidebook no. 12). Brussels, Belgium: REHVA.
- Boubekri, M. (2008) *Daylighting, Architecture and Health - Building Design Strategies*. Oxford, England: Architectural Press.
- Bronsema, B. (2013) *Earth, wind & fire: Natuurlijke airconditioning*. Delft, The Netherlands: Eburon.
- Brown, G.Z. and DeKay, M. (2001) *Sun, Wind and Light - architectural design strategies* (2nd edition). New York: John Wiley and Sons, Inc.
- Carpenter, P. (1994) *Sod It: An Introduction to Earth Sheltered Development in England and Wales*. Coventry, England: Coventry University.
- Christoffersen, J., Petersen, E. and Johnsen, K. (1997) An experimental evaluation of daylight systems and lighting control in proceedings of *Right Light* 4-2, pp. 245–254.
- Coldpack (2011) *Coldpack Airliner* (Brochure). Retrieved from http://www.coldpack.com/miscellaneous/coldpack-airliner-44/coldpack-airliner-169_en
- Corgnati, S.P. and Kindinis, A. (2007) Thermal mass activation by hollow core slab coupled with night ventilation to reduce summer cooling loads in *Building and Environment* 42, pp. 3285-3297.
- Crosbie, M.J. [ed] (1998) *The Passive Solar Design and Construction Handbook*. New York: John Wiley & Sons.
- Duffin, R.J. and Knowles, G. (1984) Use of layered walls to reduce building temperature swings in *Solar Energy* 33-6, pp. 543-549.
- Dunster, B., Simmons, C. and Gilbert, B. (2008) *the ZEDbook -solutions for a shrinking world*. Abingdon, England: Taylor & Francis.
- Edmonds, I.R. (1993) Performance of laser cut light deflecting panels in daylighting applications in *Solar Energy Materials and Solar Cells* 29-1, pp. 1-26.
- Energyflo (2011) *Jablite Cavity wall with Energyflo* (Brochure). Retrieved from <http://www.energyflo.co.uk>
- Fi-Foil (2011) *Fi-Foil Company's GFP insulation product sheet* (Brochure). Retrieved from <http://www.gfpinsulation.com/pdf/GFPspecSheet.pdf>
- GFP insulation (2011). Retrieved from <http://www.gfpinsulation.com/>
- Goulding, J.R., Lewis, J.O. and Steemers, T.C. [ed] (1993) *Energy in Architecture - The European Passive Solar Handbook*. London, England: B. T. Batsford.

- Harris, D.J. and Helwig, N (2007) Solar chimney and building ventilation in *Applied Energy*, vol. 84, issue 2, pp. 135-146.
- Hassan, M.M. and Beliveau, Y. (2007) Design, construction and performance prediction of integrated solar roof collectors using finite element analysis in *Construction and Building Materials* 21-5, pp. 1069-1078.
- Hastings, S.R. and Wall, M. (2007) *Sustainable Solar Housing – Volume 1: Strategies and Solutions*. London, England: Earthscan.
- Hestnes, A.G., Hastings, R. and Saxhof, B. [ed] (2003) *Solar Energy Houses - strategies, technologies, examples* (2nd edition). London, England: James & James.
- Horn, R., Neusinger, R., Meister, M., Hetfleisch, J., Caps, R. and Fricke, J. (2000) Switchable thermal insulation: results of computer simulations for optimisation in building applications in *High Temperatures - High Pressures* 32-6, pp. 669-675.
- Horschig, J., Mielke, J. and Schossig, P. (2007) Wechselhaft, PCM-Latentwärmespeicher in *Deutsche Bauzeitung*, April 1st, pp. 74-77.
- ISFH (2011) Long term investigations on highly insulated glazing systems with microstructured light-redirecting films, a research overview. Retrieved from http://www.isfh.de/institut_solarforschung/lichtlenkfolien.php?_l=1
- Israëls, E. and Stofberg, F. (2010) *Energievademeecum – energiebewust ontwerpen van nieuwbouwwoningen*. Boxtel, The Netherlands: Aeneas.
- James, P.A.B. and Bahaj, A.S. (2003) Holographic optical elements: various principles for solar control of conservatories and sunrooms in *Solar Energy*, vol. 78, issue 3, pp. 441-454.
- James, P.A.B. and Bahaj, A.S. (2005) Smart glazing solutions to glare and solar gain: a 'sick building' case study in *Energy and Buildings* 37, pp. 1058-1067.
- Jensen, K.I., Schultz, J.M. and Kristiansen, F.H. (2004) Development of windows based on highly insulating aerogel glazings in *Journal of Non-Crystalline Solids* 350, pp. 351-357.
- Juanicó, L. (2008) A new design of roof-integrated water solar collector for domestic heating and cooling in *Solar Energy* 82-6, pp. 481-492.
- Juanicó, L. (2010) New design of solar roof for household heating and cooling in *International Journal of Hydrogen Energy* 35-11, pp. 5823-5826.
- Kalkman, A. and Willems, E. (2003) *Monitoring zonnewoningen te Culemborg – eindrapport*. Rotterdam, The Netherlands: CHRI.
- Kalkman, A. (2005) *Duurzame energieconcepten op basis van industrieel vervaardigde thermoactieve bouwdel-en - toepassing van prefab energiepalen en actieve vloeren in de woningbouw*. Rotterdam, The Netherlands: CHRI.
- Kalkman, A. (2007) *Duurzame energie-installatie woning te Kampen - eindrapportage monitoring*. Rotterdam, The Netherlands: CHRI.
- Kalwall (2010) *Kalwall 100™, Kalwall + Nanogel®* (Brochure). Retrieved from <http://www.kalwall.com>
- Kaushika, N.D. and Sumathy, K. (2003) Solar transparent insulation materials: a review in *Renewable and Sustainable Energy Reviews*, issue 7, pp. 317-351.
- Koschensch, M. and Lehmann, B. (2004) Development of a thermally activated ceiling panel with PCM for application in lightweight and retrofitted buildings in *Energy and Buildings* 36-6, pp. 567-578.
- Kristinsson, J. (2002). *Integraal ontwerpen: Vitale architectuur*. Deventer, The Netherlands: KristinsReitsema.
- Kristinsson, J., and Van den Dobbeltstein, A. (2012) *Integrated sustainable design*. Delft, The Netherlands: Delftdigitalpress.
- Kumar, R., Sachdeva, S. and Kaushik, S.C. (2007) Dynamic earth-contact building: a sustainable low-energy technology in *Building and Environment* 42-6, pp. 2450-2460.
- Lampert, C.M. (2004) Chromogenic smart materials in *Materials Today* 7-3, pp. 28-35.
- Lawrence Berkeley National Laboratory (2011). Retrieved from <http://www.lbl.gov/Science-Articles/Archive/airliner-packaging.html>
- Lechner, N. (2001) *Heating, Cooling, Lighting: Design Methods for Architects* (2nd edition). New York: John Wiley and Sons, Inc.
- Lehmann, B., Dorer, V. and Koschensch, M. (2007) Application range of thermally activated building in *Energy and Buildings* 39-5, pp. 593-598.
- Lindenberger, D., Bruckner, T., Morrison, R., Groscurth, H.-M. and Kümmel, R. (2004) Modernization of local energy systems in *Energy*, issue 29, pp. 245-256.
- Looman, R.H.J. and Van Esch, M.M.E. (2010) *Passive solar design – where urban and building design meet in Design and Nature* V, pp. 129-138. Southampton, England: WIT Press.

- Meister, M, Horn, R., Hetfleisch, J., Caps, R. and Fricke, J. (1999) Switchable thermal insulation for solar heating in proceedings of Thermal Conductivity 24 – Thermal Expansion 12, pp. 417-427.
- Merck (2016) Liquid Crystal Window technology licrivation™ – crystal clear visions for architecture (Brochure). Retrieved from http://www.merck-performance-materials.com/corp.performance_materials/en/images/LCW_Brochure_EN_tcm2033_141362.pdf
- Müller, H.F.O. (1994) Application of holographic optical elements in buildings for various purposes like daylighting, solar shading and photovoltaic power generation in Renewable Energy 5-5/8, pp. 935-941.
- NEN (2004) ISO 15469:2004 - Spatial distribution of daylight - CIE standard general sky.
- NEN (2008) NEN-EN-ISO 13786:2008 - Thermal performance of building components - Dynamic thermal characteristics – Calculation methods.
- Okalux (2011) Okapane, Okagel (Brochure). Retrieved from <http://www.okalux.de>
- Olgay, A. and Olgay, V. (1976) Solar control & shading devices. New Jersey: Princeton University Press.
- Oliveti, G., Arcuri, N., De Simone, M. and Bruno, R. (2012) Solar heat gains and operative temperature in attached sunspaces in Renewable Energy 39-1, pp. 241–249.
- Papaefthimiou, S., Leftheriotis, G., Yianoulis, P., Hyde, T.J., Eames, P.C., Fang, Y., Pennarun, P.-Y. and Jannasch, P. (2006) Development of electrochromic evacuated advanced glazing in Energy and Buildings 38, pp. 1455–1467.
- Raessi, S. and Taheri, M. (2000) Skytherm: an approach to year-round thermal energy sufficient houses in Renewable Energy 19-4, pp. 527-543.
- Sage Electrochromics (2011) Retrieved from <http://www.sage-ec.com>
- Saint Gobain (2010) Climalit, Climaplus, Climaplus 4S, Clima-Lite Xtreme, Climatop Ultra N, Climatop Max (Brochure). Retrieved from <http://nl.saint-gobain-glass.com>
- Seeboth, A., Schneider, J. and Patzak, A. (2000) Materials for intelligent sun protecting glazing in Solar Energy Materials and Solar Cells 60-3, pp. 263-277.
- Somani, P.R. and Radhakrishnan, S. (2003) Electrochromic materials and devices: present and future in Materials Chemistry and Physics 77-1, pp. 117-133.
- Strängbetong (2011a) TermoDeck reference list. Retrieved from <http://www.strangbetong.se>
- Strängbetong (2011b) Passivhuset Lärkrädet i Vara (Brochure). Retrieved from <http://www.strangbetong.se>
- Swiss Solar Agency (2006) Swiss Solar Prize 2006. Zurich, Switzerland: Swiss Solar Agency.
- Szokolay, S.V. (2008) Introduction to Architectural Science - the basis for sustainable design [second edition]. Oxford, England: Architectural Press.
- Tholl, H.D., Kubiza, R. and Stojanoff, C.G. (1994) Stacked volume holograms as light directing elements in Proceedings of Optical Materials Technology for Energy Efficiency and Solar Energy Conversion XIII - SPIE 2255, pp. 486-496.
- TNO-MEP (2003) Handboek Energiepalen. Apeldoorn, The Netherlands: Author.
- Van den Ent, J.J., Faber, C. and Schut-Baak, P.A. (1982) Integraal ontwerpen – zonnepouwoningen te Leiderdorp. Delft, The Netherlands.
- Van der Linden, A.C. (2006) Bouwfysica. Utrecht, The Netherlands: ThiemeMeulenhoff.
- Van der Spoel, W.H., Philippa, R.A. and Van Swieten, P.M.J. (2008) Passive cooling using adaptable insulation; final report for SenterNovem BSE-2005 program entitled 'passieve koeling middels schakelbare isolatie'.
- Van Esch, M.M.E., Looman, R.H.J. and De Bruin-Hordijk, G.J. (2012) The effects of urban and building design parameters on solar access to the urban canyon and the potential for direct passive solar heating strategies in Energy and Buildings 47, pp. 189-200.
- Van Oosten, C. and Zitto, M.(2016) 30-1: Invited Paper: Liquid Crystal Windows for Adaptive Facades, SID Symposium Digest of Technical Papers, issue 47.
- Verkerk, G. (1992) Binas: Informatieboek vwo-havo voor het onderwijs in de natuurwetenschappen (3e dr.). Groningen, The Netherlands: Wolters-Noordhoff.
- Watson, D. and Labs, K. (1983) Climatic building design – energy-efficient building principles and practice. New York: McGraw-Hill.
- Weitzmann, P. (2004) Modelling building integrated heating and cooling systems. Lyngby, Denmark: Danmarks Tekniske Universitet.
- Winwood, R., Benstead, R. and Edwards, R. (1997) Advanced fabric energy storage in Building Services Engineering Research and Technology 18, pp. 1-30 (article is divided into four parts: review, computational fluid dynamics modelling, theoretical analysis and whole building simulation, experimental monitoring).
- Wittwer, V., Datz, M., Ell, J., Georg, A., Graf, W. and Walze, G. (2004) Gasochromic windows in Solar Energy Materials & Solar Cells 84, pp. 305–314.

- Wong, I.L., Eames, P.C. and Perera, R.S. (2007) A review of transparent insulation systems and the evaluation of payback period for building applications in *Solar Energy*, vol. 81, issue 9, pp. 1058-1071.
- Yanovshtchinsky, V., Huijbers, K., and Van den Dobbelsteen, A. (2013) *Architectuur als klimaatmachine - Handboek voor duurzaam comfort zonder stekker*. Amsterdam, The Netherlands: uitgeverij SUN.
- Young, B., Thiele, A., Fujii, A., Sant, G. and Pilon, L (2013) Thermophysical properties of phase change materials. Retrieved from <http://www.seas.ucla.edu/~pilon/Publications/DataDownloads/ThermophysicalPropertiesPCMnearRT.xlsx>
- ZAE Bayern (2011) *Switchable Insulation for Utilizing Solar Energy in Buildings* (Research project). Retrieved from <http://www.zae.uni-wuerzburg.de/english/division-2/projects/archive/si.html>

7 A framework for a climate-responsive design decision support tool

The architectural design process is very complex. Miscellaneous objectives have to be met in the final design. Creativity and high levels of expertise are required to come up with a fulfilling result. As mentioned in chapter 2 experts can be of help but are in practice scarcely used within the early design stages of analysis and concept development. Therefore, architects need to make these decisions themselves, which requires general knowledge of climate-responsive design, provided to them in the form of an informative support tool. The key elements of knowledge transfer and transformation were presented in chapter 2.

The basic layer of information on energy and comfort was studied in chapters 3 and 4. In chapter 3 the comfort and energy demands of climate-responsive design were researched. In chapter 4 the climate potential of the built environment to meet those comfort demands were quantified. In chapter 5 the concept of climate-responsive design was further deduced, followed by a more in depth research into some of the identified climate-responsive building elements on the aspects of performance, process and architectural consequences in chapter 6.

In this chapter a framework for a climate-responsive design decision support tool is presented. The chapter starts with stating the requirements of the tool (section 7.1), followed by the presentation of a preliminary working concept of the tool in section 7.2. In section 7.3 the conformation of the tool in its presented form to the stated requirements in section 7.1 is discussed, followed by the discussion of collected feedback from architects that worked with the tool in section 7.4. In the final section 7.5 recommendations are stated for the future development of the tool.

§ 7.1 Requirements

The objective is to formulate the foundations of a framework for the support tool that provides informative support with the goal to assist in decision making during the early stages of the design process (see section 2.5). The key elements are split into requirements for content, function and form. The requirements for the content were determined in section 5.5. The requirements for the function are derived from a literature analysis of (architectural) design decisions support tools. The requirements for the form of the tool are derived from the theoretical framework given in chapter 2.

§ 7.1.1 Content requirements

In section 5.5 the requirements regarding the content of the design support tool were defined, as the result of the theoretical framework presented in chapter 2 and the knowledge generated and gathered in chapters 3, 4 and 5.

In summary, the following enumeration of content requirements for the framework of the climate-responsive design decision support tool can be given:

- **Performance**
the comfort contribution and energy performance of a design solution;
- **Process**
the possible disagreements between the employment of the energy function of climate-responsive building elements and their primary (or other) function, and the identification of collaborations and conflicts when using multiple design principles together;
- **Architectural consequences**
the impact of climate-responsive building elements on the appearance of design.

The actual content is (partially) 'produced' in chapter 6, differentiated between the aspects of performance, process and architectural consequences. In section 7.3 the conformation of the framework to these requirements is discussed.

§ 7.1.2 Functional requirements

Different studies have been conducted into the need for and the preferred method of decision support tools in the early stages of the design process. Erbas and Van Dijk (2012) surveyed architects to identify their preferences and needs with respect to the use of decision support tools in the case of designing high performance green buildings. They concluded that a possible decision support tool should **include a knowledge base with expert knowledge and best practice examples**. The main output of their envisioned tool should **provide possible enhancements for the design choices and informative assessment of design alternatives**. In a study by Attia et al. (2012a) architects ranked intelligence as the most important feature of a decision support tool - preferred over accuracy, interoperability and usability - where intelligence was defined by the architects as **the ability to inform during and assist in decision-making**. Attia et al. (2012b) proposed a method how to include building performance simulation (BSP) into the early stages of the design process.

Key elements to be considered in the development of such a tool include the presence of **informative support during the decision-making** - instead of post-evaluative - and **the ability to communicate design alternatives**. Furthermore the output of the tool should be clearly defined, comprehensible and allow for logical iteration within the cyclic process when designing.

The use of building performance simulation (BPS) and computer-aided architectural design (CAAD) tools in the early stages of the design process has been widely researched (Ellis & Mathews, 2002; Hensen, 2004; Shaviv, 1999; Yeziro, 2008). The suggested benefits of using such tools in the early design stages are to be found in calculating performance of design decisions and comparing design alternatives based upon simulation results. Ongoing research on this topic has moved to identifying the downsides of using such tools in the early design stages and the need for improvements (Kanters et al., 2014), and the setting up of a blueprint for the development of next-generation tools (Attia et al., 2012b). **The found drawbacks include its complexity, the need for time-consuming simulations, the difficulty in interpreting the results and the overall notion that it does not attune to the architect's method of working.**

In the early stages of the design process climate-responsive design is about the generation of energy concepts. In this phase accessible guidelines and the option to compare alternatives is more important than to assess absolute performance. The conceptual design phase is dynamic and has many iterations. Informative, context-specific knowledge reduces the number of iterations before the architect has generated a satisfying number of design options from which he or she can continue to the next design phase of assessment. The climate-responsive design-decision support tool aims to address these essential elements.

In conclusion, the following enumeration of functional requirements for the framework of the climate-responsive design decision support tool can be given:

- include a knowledge base with expert knowledge and best practice examples
- provide informative, context-specific knowledge
- provide accessible guidelines
- provide an option to compare alternatives
- include the ability to inform during and assist in decision-making (i.e. intelligence)
- limit complexity and generate easy to interpret output

In section 7.3 the conformation of the framework to these requirements is discussed.

§ 7.1.3 Form requirements

The tool is primarily developed for the architect so it needs to blend in the architect's workflow enabling the architect's creativity, guiding his or her intuition and presented in a highly visual style (section 2.2). In addition, the tool should tie to the generation phase, the process of conceptual design with the generation of design options (section 2.5). Tool adoption by architects may increase if it can be customised to their needs.

The tool should allow knowledge to be accessed from any of the three different design orientations (site, program and concept; section 2.4). The information on comfort and energy can be best quantified and presented in tables and figures that are easy to read. This information is particularly of use to program-orientated architects. The information on energy harvest should show conditions with respect to orientation and dimension. When clearly overviewed in schemes and matrices this information best suits a site-orientated architect. Finally, information on the sustainable visibility factor of design solutions and the identification of possible alternatives, especially when presented illustratively, best suits the concept-orientated architects. Such images include sketches of design solutions and an image pool of project examples.

As opposed to access from one of three different design orientations, the tool should also give room for free exploration, in which the user can wander around the knowledge from any chosen starting point. This may induce the process of creative thinking and by doing so unlocking the generation of new ideas on how to incorporate principles of climate-responsive design in architecture. In order to give room for exploration, the tool should be able to allow custom navigation patterns.

In conclusion, the following enumeration of form requirements for the framework of the climate-responsive design decision support tool can be given:

- enable or give room to creativity
- offer customisation options
- prevent misinterpretation through proper guidance
- present in a visual style
- allow custom navigation patterns

In section 7.3 the conformation of the framework to these requirements is discussed.

§ 7.2 Concept tool

Drawn from the aforementioned requirements the design decision support tool is best met by a web-based tool. Web-based means that it is easy accessible from any device connected to the internet. The interface can either be a website that can be accessed from any browser or a dedicated web-application (i.e. a website that feels like a native application). A website or web-application is preferred over a native application or computer program since it eliminates the need for active updating in order to gain new features or content. So, the end user always has access to the most up to date content.

One major advantage of digital forms, such as websites or applications, over printed forms is the ability to create complex navigation patterns throughout the content without losing track, by using breadcrumbs and the possibility to take one or more steps back. Other advantages over the printed form is the possibility to apply custom filters on the content to quickly access only that information the architect finds suitable, and the possibility of additional layers of intelligence that can make the architect aware of resulting considerations and possible consequences after filtering content. In addition, selected content can be centrally saved for future reference.

A concept of the web-based tool has been developed - available online at <http://www.climateresponsivedesign.nl/tool> - in order to illustrate what a climate-responsive design-decision support tool could look like. The goal of this concept is to present some of the elements of the tool, illustrate in what ways the user can navigate through the knowledge, and in what ways the interrelationships between different content parts within the knowledge base are shared with the user. Since it is a concept it does not contain all content or desired functions.

The concept tool is validated in section 7.3, by discussing the conformation of the tool to the stated requirements. In section 7.4 the concept tool in its current form is reviewed using feedback from architects that used the tool for some time during their design work. Combined with own findings, the feedback from the architects is used to present suggestions for the further development of the tool in section 7.5.

§ 7.2.1 The knowledge base

The heart of the tool is formed by the knowledge base, constructed from items grouped into one of four categories: principles, solutions, projects and guidelines. An overview of all items in these categories are directly accessible from the menu and thus provide initial access to the underlying content. In order to understand the structure of the knowledge base and how to navigate through the content, the main aspects - relationships, stored content, overviews and bookmarks - are explained in more detail, using screenshots of the concept tool where available.

Relationships

Figure 7.1 shows a schematic representation of the relationships that exist between any item that populates the knowledge base, namely principles, solutions, projects and guidelines. Projects are assigned to solutions, which in turn are assigned to principles. There is no direct link between projects and principles. A principle can contain one or more solutions, and any solution is linked to one or more principles. Any solution is linked to one or more projects, and any project is linked to one or more solutions. Solutions that share the same principle are interlinked as well, to quickly identify alternative solutions that share the same principle. Both a principle and a solution can be associated with one or more relevant guidelines. All presented relations are incorporated within the knowledge base as hyperlinks, which makes it easy to navigate from one item to another.

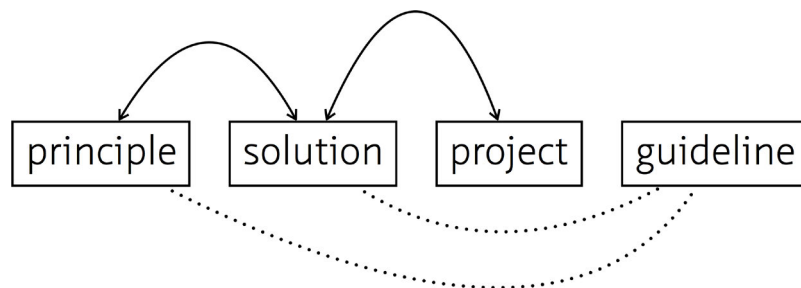

FIGURE 7.1 Relationships between principles, solutions, projects and guidelines in the climate-responsive design knowledge base.

Stored content

The information stored within the knowledge base differs per category, and is most comprehensive for principles, solutions and projects:

- **Principles**
a short introduction including a qualitative description of the solutions based upon that principle, some references (i.e. articles, books, websites), associated energy sources, comfort provisions and energy treatments, indicated by icons, and a list of links to related solutions and relevant guidelines
- **solutions**
a short description, and thorough information on performance, process and architectural impact, some references (i.e. articles, books, websites), a sketch to give a quick visual indication of the concept, associated energy sources, comfort provisions and energy treatments, an indication of the visual impact, and a list of links to related principles and projects, relevant guidelines and similar solutions
- **projects**
some metadata about the status, scale, location and architect, some illustrative photographs and drawings, some references (i.e. articles, books and website), and a list of applied solutions
- **guidelines**
a short description and some additional explanation

Overviews

Catalogue

The menu of the tool gives direct access to an overview of all items within a single category. The overview pages are presented in multiple ways. A first way is in the form of a catalogue for all items in each category (with the exclusion of the guidelines). The catalogue consists of a condensed version of the stored information per single item where the description is exchanged for a short summary accompanied by a direct link to info sheet. Sketches, icons, photos and links to related principles, solutions and projects are also shown ([Figure 7.2](#), [Figure 7.3](#), [Figure 7.4](#)).

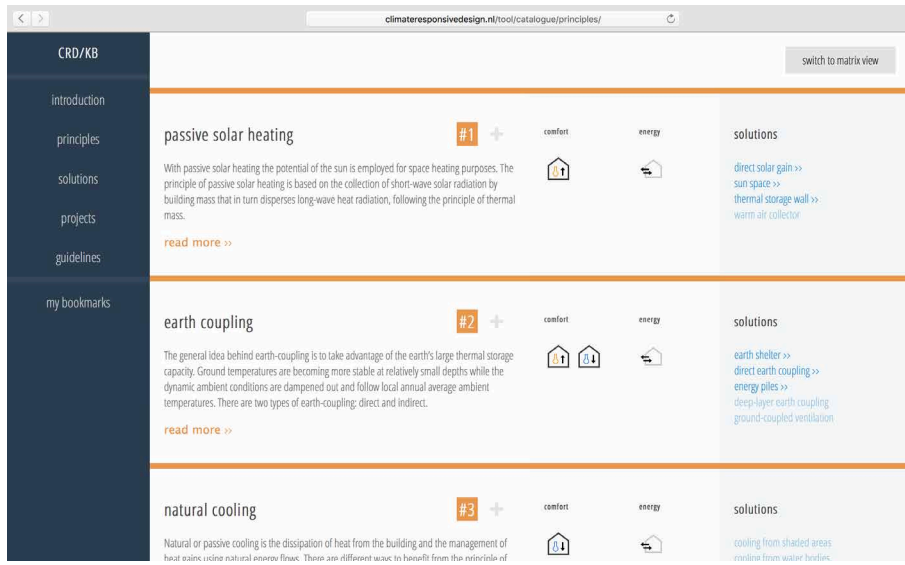

FIGURE 7.2 Screenshot of (partial) catalogue with design principles.

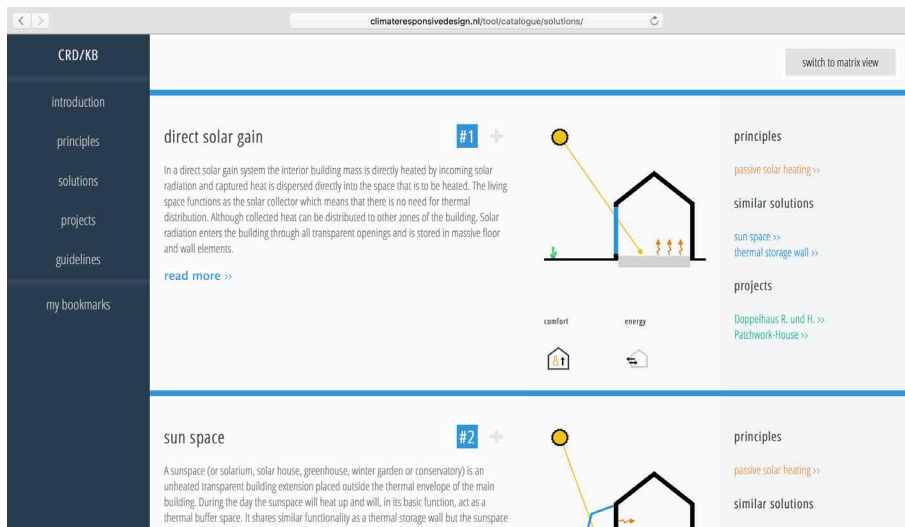

FIGURE 7.3 Screenshot of (partial) catalogue with design solutions.

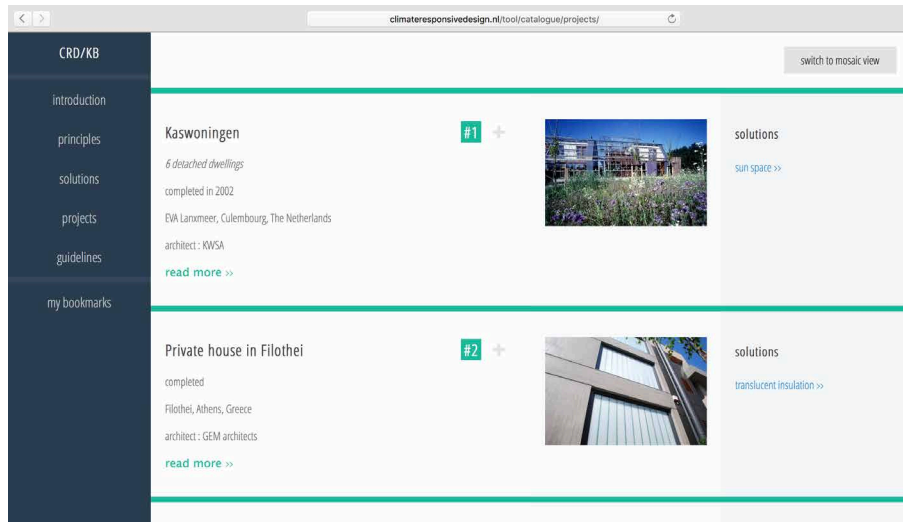

FIGURE 7.4 Screenshot of (partial) catalogue with project examples.

Matrix

As an alternative way to quickly scan different design principles or design solutions is through the use of a matrix. There are three different matrices, all already presented in chapter 5. Design principles are presented in a matrix of comfort provision against energy treatment (Figure 7.5; Table 5.3) and presented in a second matrix of comfort provision against energy source (Figure 7.6; Table 5.4).

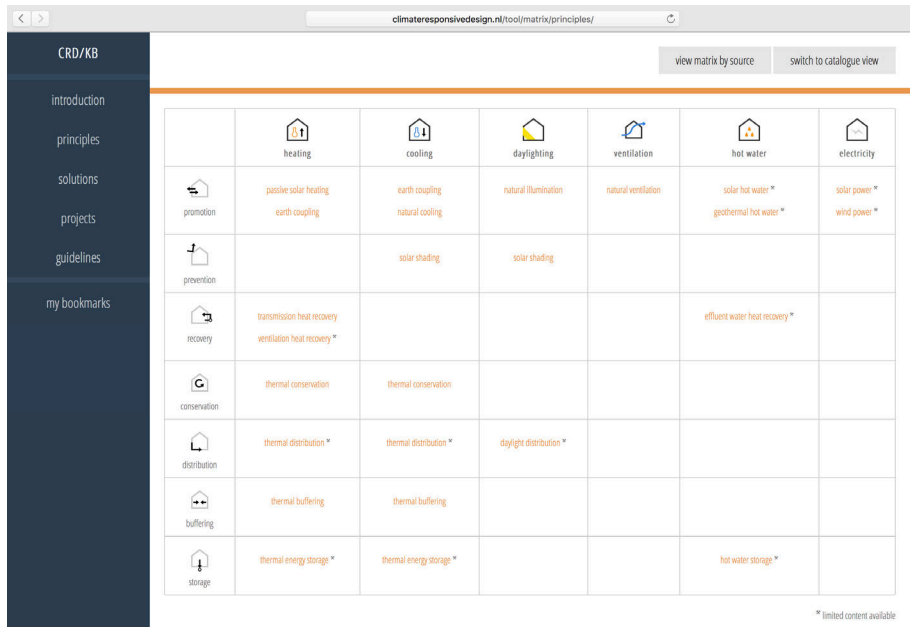

FIGURE 7.5 Screenshot of matrix of design principles, presented as comfort provision against energy treatment.

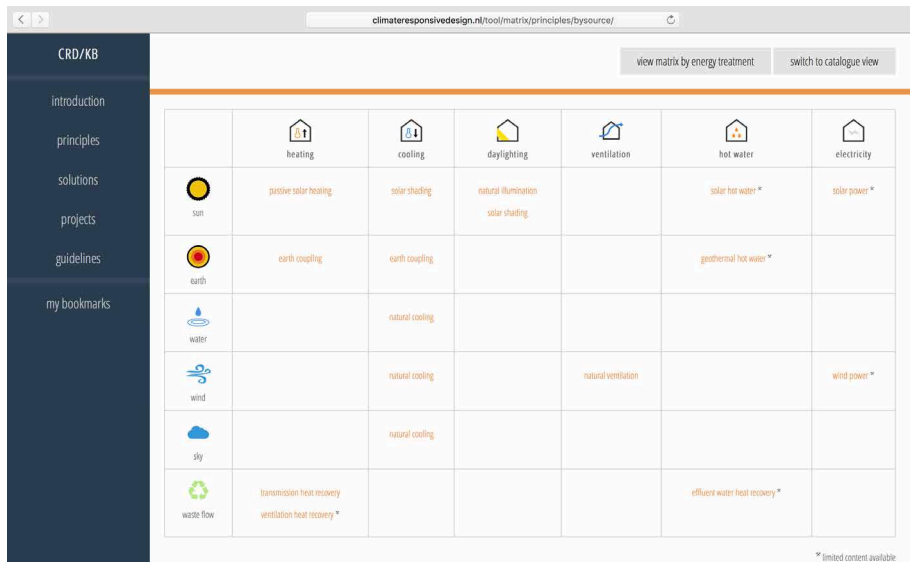

FIGURE 7.6 Screenshot of matrix with design principles, presented as comfort provision against energy source.

The solutions are presented in a matrix of principles against design solution type (Figure 7.7; Table 5.7).

climateresponsivedesign.nl/tool/matrix/solutions/

switch to catalogue view

	site planning	building form & layout	building structure	building skin	building finish	(integrated) building services
passive solar heating			thermal storage wall >>	direct solar gain >> sun space >>		warm air collector
earth coupling			direct earth coupling >> energy piles >>	earth shelter >>		deep layer earth coupling ground-coupled ventilation
natural cooling	cooling from shaded areas cooling from water bodies			roof pond >>		
night-sky cooling						
natural air cooling	cooling from shaded areas cooling from water bodies					
evaporative cooling				roof pond >>		
natural illumination				chromogenic glazing >> light shelf >> translucent insulation >> light-redirecting glazing >>		
natural ventilation				solar chimney >> wind catcher >>		
solar-driven ventilation				solar chimney >>		
wind-driven ventilation				wind catcher >>		
solar hot water *						solar thermal collector
geothermal hot water *						deep layer earth coupling
solar power *						photovoltaic cell
wind power *						urban wind turbine
solar shading	shading from outdoor vegetation		structural shading device >>	chromogenic glazing >> external shading device light shelf >>	painting	
thermal conservation	wind screening from vegetation	air with compact design thermal zoning		translucent insulation >> adaptable insulation >> thermal shutter >> (integrated) wind screening		
thermal buffering			thermal mass >> thermo-activation >>		phase change material	
thermal distribution *			thermo-activation >> hollow core ventilation >>	cavity wall heating >>		
daylight distribution *				light shelf >> light-redirecting glazing >>		
transmission heat recovery				boundary wall heat recovery dynamic insulation >>		
ventilation heat recovery *						double-glazed window
effluent water heat recovery *						
thermal energy storage *						
hot water storage *						

* limited content available

FIGURE 7.7 Screenshot of matrix with design solutions.

Gallery

The projects are also presented in a gallery; an alternative catalogue style using only photos. The photos link directly to the info sheet of the selected project (Figure 7.8).

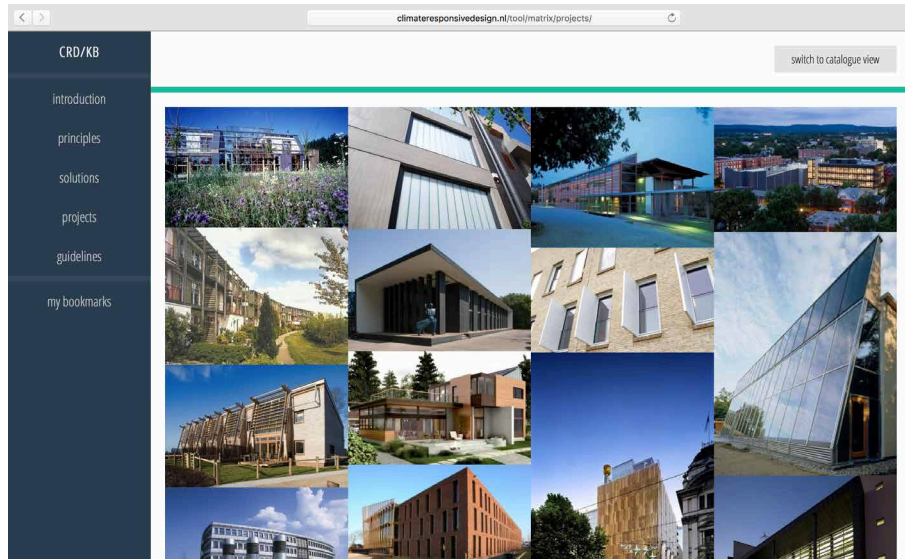

FIGURE 7.8 Screenshot of image gallery with project examples.

Infosheets

The most detailed presentation style of stored content is through info sheets containing all available information for an item. [Figure 7.9](#), [Figure 7.10](#), [Figure 7.11](#) show screenshots of info sheets of a randomly selected principle, solution and project. Guidelines do not have info sheets since there is only a limited amount of information stored on guidelines in the knowledge base. The formatting of info sheets is very similar for the different categories, consisting of a main content area containing descriptive information and a smaller column to the right with the visual elements (sketches and icons) and links to related content from the knowledge base. The info sheet of a project has a second smaller column showing photos and drawings.

The screenshot shows a web browser window with the URL `climateresponsivedesign.nl/tool/datasheet/principles/index.php?id=1`. The page is titled "passive solar heating" and is part of a knowledge base (CRD/KB). The left sidebar contains navigation links: introduction, principles, solutions, projects, guidelines, and my bookmarks. The main content area is divided into several sections:

- passive solar heating** (with a "#1" icon)
- comfort** and **energy** (with house icons)
- solutions**:
 - [direct solar gain >>](#)
 - [sun space >>](#)
 - [thermal storage wall >>](#)
 - [warm air collector](#)
- guidelines**:
 - 551
 - 571
 - 601
 - 611
 - 661
- references**:
 - Goulding, J.R., Lewis, J.D. and Seemers, T.C. [ed] (1993) *Energy in Architecture – The European Passive Solar Handbook*, B. T. Batsford, London.
 - Crosbie, M.J. [ed.] (1998) *The Passive Solar Design and Construction Handbook*, John Wiley and Sons, Inc., New York.
 - Hestnes, A.G., Hastings, R. and Saahel, B. [ed] (2003) *Solar Energy Houses – strategies, technologies, examples* (2nd edition), James & James, London.

At the bottom, there is a small copyright notice: "Windows © D and Mail 14 79079 Copyrightable Color Materials - Volume 1 - Grenadier und Calabrese - Eindhoven - London".

FIGURE 7.9 Screenshot of the info sheet of a design principle.

climateresponsivedesign.nl/tool/datasheet/solutions/index.php?id=2

CRD/KB

introduction

principles

solutions

projects

guidelines

my bookmarks

sun space

#2

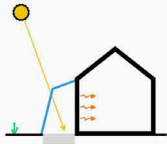

A sunspace (or solarium, solar house, greenhouse, winter garden or conservatory) is an unheated transparent building extension placed outside the thermal envelope of the main building. During the day the sunspace will heat up and will, in its basic function, act as a thermal buffer space. It shares similar functionality as a thermal storage wall but the sunspace is large enough to be used as an additional living space; only when the climate is not too severe.

performance

In its most simple form a sunspace acts as a thermal buffer space, minimising heat losses of the main building. Due to its construction a sunspace heats up (and cools down) much quicker than the main building. The thermal buffer concept works best if the separation wall between the sunspace and the main building is not very well insulated. The sunspace itself then needs some degree of insulation. Alternatively, the sunspace can also be used to preheat ventilation air. By equipping the sunspace with large transparent areas and minimal insulation, the sunspace will respond more quickly to changes in temperature and solar radiation. The temperature in a sunspace will then be some degrees higher than ambient temperature. In winter this collected heat can be used to preheat ventilation air for the living spaces of the main building by opening doors and windows to the sunspace. In summer the temperature of the sun space will be too severe if no additional measures are taken. These measures may include a (additional) insulation of the separation wall to the main building, shading of the sun space roof and abundant natural ventilation of the sun space to flush excessive heat.

The potential of the sunspace is illustrated with the Glass House dwellings by KWSA architects (image 1). The operational performance of the Glass house dwellings were part of an extensive research project in which expected performance of the dwellings was compared to monitoring results obtained during occupancy [Kalkman and Willems 2003]. The average indoor air temperature of the living room during a persistent hot period in summer measured 24.2 °C. When the ambient temperature drops to a low 15.3 °C early in the morning, the temperature of the sunspace and the core dwelling have dropped to respectively 17.5 °C and 21.4 °C¹. The temperature inside the core dwelling reaches a maximum of 25.8 °C at the end of the day. To control the indoor temperatures the core dwelling can be cooled when ventilated directly with the cooler ambient air in the evening and the night, and from the base of the sunspace in the morning until the afternoon. The temperature in the base of the sunspace is much cooler than ambient temperature, which can be explained from the large thermal capacity of the soil. The temperature development of the core dwelling shows a slight heat accumulation under these severe climatic conditions.

Measurements for a typical sunny, mid-season day reveal that the average temperature in the sunspace throughout the night is some degrees higher than the ambient temperature. The temperature in the lower part of the sunspace (base) stays much below the temperatures measured on elevated heights (front and roof) and reaches a maximum of 23 °C. The temperature course of the core dwelling shows no heat accumulation under these climatic conditions.

The assessment of comfort perception of the occupants revealed that core dwelling was considered warm, but comfortable. Remarkably, the sunspace is considered to be as comfortable as the core dwelling while its temperature is most of the time several degrees higher. Apparently, the occupants accept higher temperatures in the sunspace than in the core dwelling. As from October, the sun space is considered to be cold to dwell in.

Computer simulations on the effect of the presence of the solar space on the heat demand of the core dwelling showed a net decrease of 2 GJ. A 2.9 GJ decrease in transmission losses is partly counterbalanced by a loss in passive solar gains of 0.9 GJ².

process

In urban environments, solar exposure of individual houses is constrained by street layouts and the shape of neighbouring buildings. Obstructions put restrictions on the solar exposure of transparent openings in the building skin and thus on the potential of solar radiation in a passive solar heating strategy. An extensive study was conducted into the effects of urban parameters (street width and orientation) and architectural parameters (roof shape and building envelope design) on solar access to the urban canopy and the viability of passive solar heating strategies in residential buildings [Van Esch et al. 2012, Looman and Van Esch 2010]. In a typical urban layout with a street width of 15 m during the winter when sun angles are low, approximately 70% of the sunlight to which a building is exposed to is harvested at the roof and the topmost floor. This would favour the positioning of the sunspace on top of the building. This concept of a solar attic functions similar to that of other indirect solar heat gain systems but with enlarged solar exposure and less obstruction from neighbouring objects the solar attic can still be effective in denser urban developments.

architecture

Sunspaces exist in many sizes, ranging from attached to a single floor or an entire facade (image 2) or even spanning the whole building (image 1). This latter concept creates additional living spaces outside of the core building that can be put to use depending on activity and time of year.

Sunspaces can be added to the building when remodelling houses since it is merely an extension. However, this will claim space from the surrounding property turning outdoor space into semi-indoor space.





image 1 | Glass covered dwellings: Glass house dwellings in Culemborg, the Netherlands by KWSA (photo by KWSA).

image 2 | Three storey high sunspace: Eco-dwellings Carlsen, Heerlen, the Netherlands by Rens Pijneborg.

references

Kalkman, A. and Willems, E. (2003) Monitoring zonnewoningen te Culemborg - eindrapport, CHRL, Rotterdam.

Van Esch, M.M.E., Looman, R.H.J. and De Bruijn-Hordijk, G.J. (2012) The effects of urban and building design parameters on solar access to the urban canyon and the potential for direct passive solar heating strategies in Energy and Buildings 47, pp. 189-200.

Looman, R.H.J. and Van Esch, M.M.E. (2010) Passive solar design - where urban and building design meet in Design and Nature V, pp. 129-138, WIT Press, Southampton.

¹ By way of comparison the reference dwelling would measure a temperature of 25.8 °C early in the morning under identical climatic conditions.

² However, actual energy use measurements during occupancy showed occasional primary energy demands up to 120% higher than what pre-design calculations predicted. These numbers were validated by dynamic computer simulations and were explained from 'excessive' ventilation of the core dwelling (i.e. ventilation rates that are much higher than the Dutch building regulations prescribe in order to maintain healthy indoor air quality standards).

comfort

energy

passive solar heating >>

similar solutions

direct solar gain >>

thermal storage wall >>

projects

Kaswoningen >>

Office and Appartment House, Gleisdorf >>

Great Bow Yard >>

guidelines

551 601

FIGURE 7.10 Screenshot of the info sheet of a design solution.

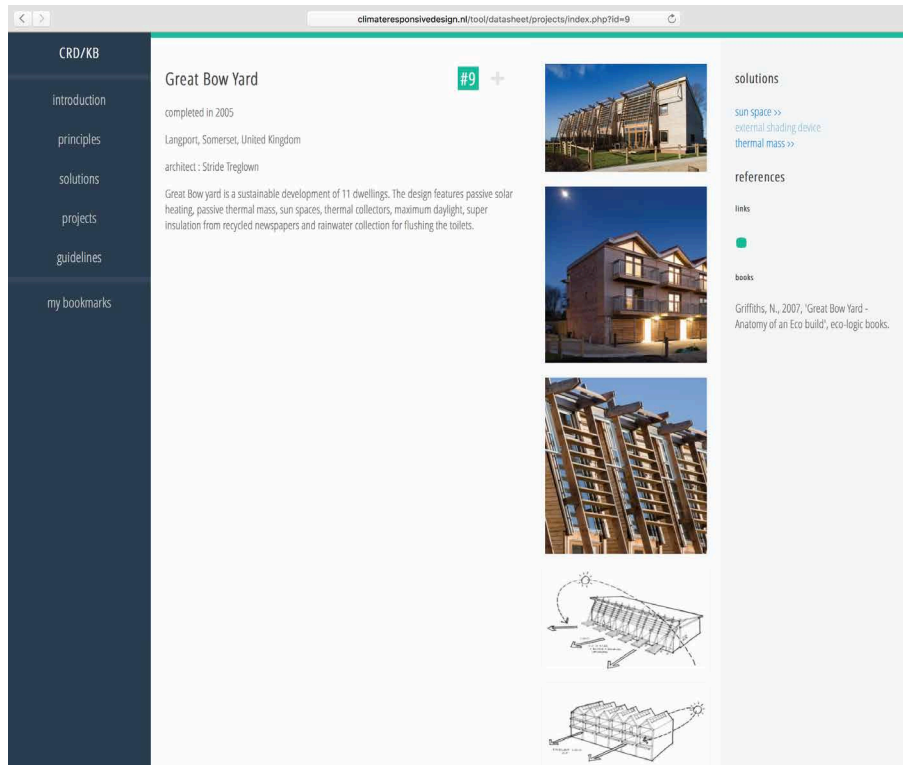

FIGURE 7.11 Screenshot of the info sheet of a project example.

Guidelines

The guidelines are split into analytical guidelines and concept development guidelines. The analytical guidelines relate to the exploration of possibilities and limitations of climate-responsive design and are split into:

- identification of spatial and functional boundary conditions (section 3.3.1)
- identification of comfort-related objectives and constraints (section 3.3.2)
- inventory of climate potential (section 4.4)

The concept development guidelines relate to the generation of design options and are split into:

- putting forward the hidden energy purpose of building elements (section 6.10)
- showing possible conflicts when applying certain principles or solutions (section 6.10)
- mapping the synergetic effects when stacking design principles and solutions (section 6.10)

The guidelines are presented in lists and tables on the overview pages (Figure 7.12).

identification of user-related objectives and constraints

What we define as comfortable has far-reaching implications for the way we design buildings and how we operate them, and therefore, the energy use for controlling an indoor environment to maintain a certain level of comfort. For example, the employment of passive solar heating directly tuned to the actual heating demand, thus optimized for the times most needed, and only complemented with strategies of thermal buffering and storage. The identification of user-related objectives and constraints (e.g. minimal indoor climate requirements, user-related comfort demands) form a starting point of climate-responsive design.

table 2 comfort-related boundary conditions and their effect on the energy concept.

comfort-related parameter	description	guidelines
Thermal comfort requirements and target values (traditional vs. adaptive)	Determines the general heating and cooling strategy.	201 Tune passive heating strategies to the heating demand, thus optimize for the times most needed, and complement with strategies of conserving or storing energy.
		202 Group zones with similar requirements and position them in the building plan (orientation, floor level) according to the energy offer.
Summer comfort	Strategies to prevent and overcome issues of overheating.	211 Prevent issues of overheating by keeping heat out or accelerated discharge of gained heat.
		212 Apply passive cooling strategies using lower temperature sources in the surroundings.
Air quality requirements (e.g. maximum CO2 concentration)	When and where to ventilate.	221 Eliminate contamination sources as much as possible.
		222 Employ demand-control-ventilation: design for decentralized ventilation with heat recovery in cold periods.
Humidity requirements	Defines humidity-control measures.	231 Moisture buffering strategies (e.g. hygroscopic interior wall and ceiling)

FIGURE 7.12 Partial screenshot of guidelines overview.

Bookmarks

Whenever the user wants to keep an item for future reference, the user has the ability to bookmark it. All bookmarked items are listed on a special page and can be managed from there (Figure 7.13).

By clicking on links the user navigates through the available knowledge. Any link to a principle, solution or project is clickable and brings you directly to the relevant info sheet. Using the common navigation function of web browsers the user can go back and forth to the visited pages.

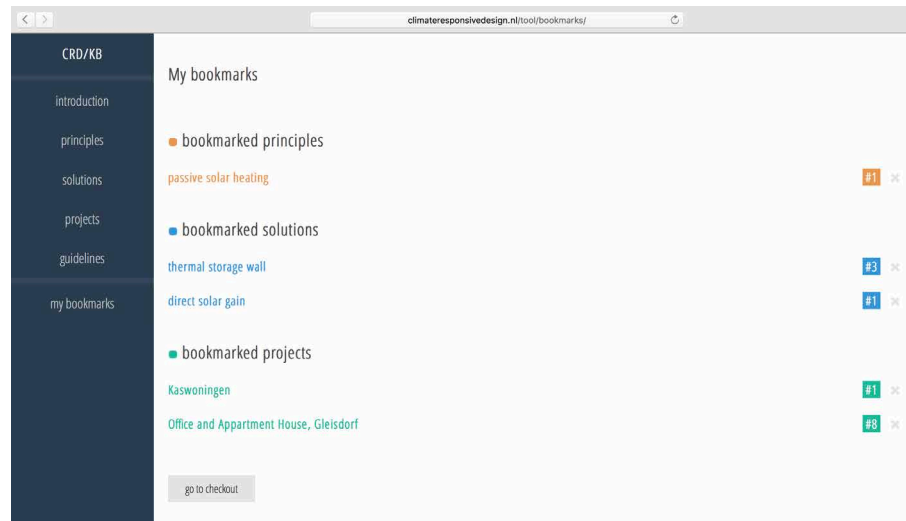

FIGURE 7.13 screenshot of 'my bookmarks' page.

§ 7.2.2 Illustration of custom navigation patterns

The tool allows knowledge to be accessed from any of the three different design orientations (site, program and concept; section 2.4) by starting from the guidelines or one of the matrix overviews. Another requirement was to give the user the ability to freely explore the contents of the knowledge base. In order to do so, the tool should allow custom navigation patterns. These patterns are schematically presented in Figure 7.14. As mentioned before the categories principles, solutions and projects are presented in overviews using a matrix or a catalogue with links to the individual info sheets. Similar solutions (e.g. solutions that share the same principle) are presented collectively in the solutions overviews and are interlinked through their info sheets.

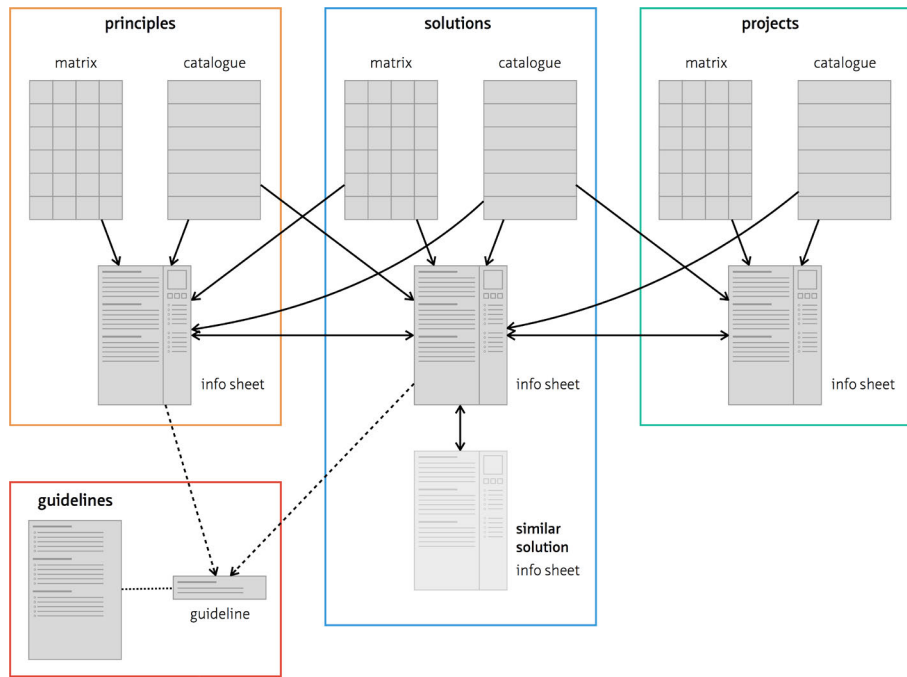

FIGURE 7.14 Scheme of custom navigation patterns.

Figure 7.15 shows an excerpt of the actual relationships that are incorporated in the concept tool. The scheme starts by showing only direct relationships of the design principle passive solar heating to the design solutions direct solar gain, sun space and thermal storage wall. From these design solutions only direct relationships to guidelines (presented by their ID for readability) and projects are shown. From the stated projects then direct relations to other design solutions are shown, And finally, from these set of solutions the direct relation to other design principles are shown. This scheme only shows 27 of 129 items (principles, solutions, projects and guidelines) that are incorporated in the concept tool. It illustrates how can be navigated freely from one item to another that have no direct connection in the knowledge base.

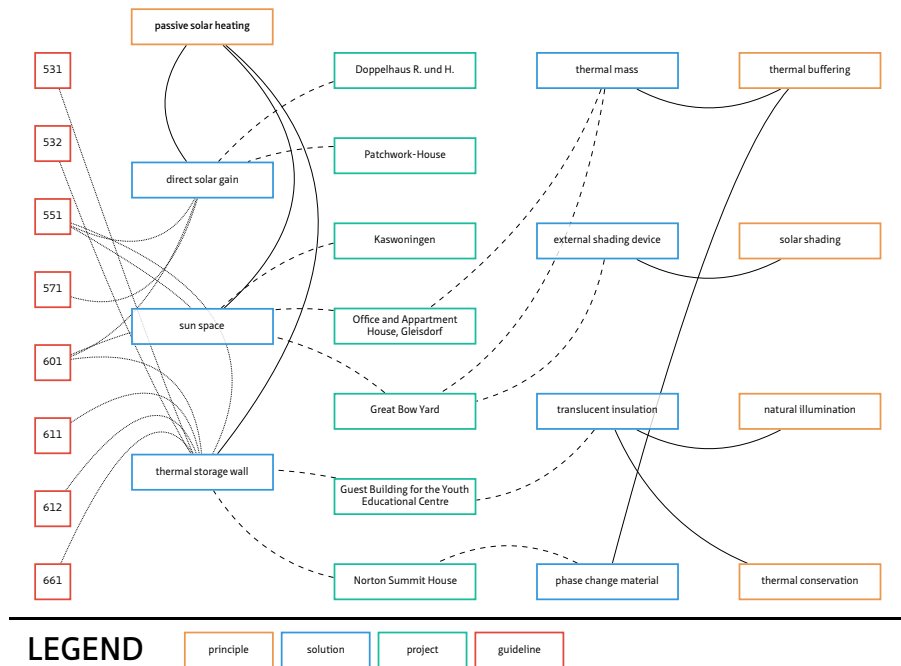

FIGURE 7.15 Excerpt of actual relationships that exist in the concept tool.

§ 7.3 Conformation to the requirements

In the previous section a concept of a climate-responsive design-decision support tool was shown. The tool aims to assist architects in making informed decisions during the development of the energy concept of a design, as part of the early stages of the design process. In this section it is examined to what extent the concept tool conforms to the requirements as listed in section 7.1:

Content requirements

- 1 the comfort contribution and energy performance of a design solution;
- 2 the possible disagreements between the employment of the energy function of climate-responsive building elements and their primary (or other) function;
- 3 the identification of collaborations and conflicts when using multiple design principles together;
- 4 the impact of climate-responsive building elements on the appearance of design.

Functional requirements

- 5 include a knowledge base with expert knowledge and best practice examples
- 6 provide informative, context-specific knowledge
- 7 provide accessible guidelines
- 8 provide the option to compare alternatives
- 9 include the ability to inform during and assist in decision-making (i.e. intelligence)
- 10 limit complexity and generate easy to interpret output

Form requirements

- 11 enable or give room to creativity
- 12 offer customisation options
- 13 prevent misinterpretation through proper guidance
- 14 present in a visual style
- 15 allow custom navigation patterns

The heart of the tool is formed by the knowledge base with descriptive information for each item. If applicable, context-specific information is communicated. For example if solutions are bounded by certain restrictions such as building height or orientation, and if a solution is applicable in renovation projects. The general principles are linked to design solutions which in turn are linked to projects examples, providing the user with real examples of climate-responsive design. This all answers to requirements #5, #6 and #13. Similar solutions, i.e. solutions based on the same design principle, are mentioned on both the solutions catalogue view and the individual info sheets and give the user possible design alternatives. Since there is no direct way to compare similar solutions - you have to study the solutions one after another - it only partially answers to requirement #8.

The content requirements #2 and #3 are met by the incorporation of different tables and lists on the guidelines overview page ([Figure 7.12](#)). Requirement #3 is also met - together with requirement #4 - with the presentation of relevant guidelines on the info sheets. Both the analytical guidelines (sections 3.3 and 4.4) and the concept development guidelines (section 6.10) help the user to become aware of beneficial and conflicting aspects when employing climate-responsive design. The user is provided with feedback on relevant issues which should assist in improved decision-making. This answers to requirements #7 and partially to requirement #9, since custom filters are not yet implemented into the tool.

Content requirement #1 is not answered to in the tool. In order to quantify comfort contribution and energy performance of any given design solution, you have to conduct calculations on the scale of whole building design. However, since the tool aims to assist architects in making informed decisions during the early stages of the

design process, decisions on many design options are not yet taken. This demands doing calculations with many variables still open and may result in an outcome that is less meaningful. Moreover, as was mentioned before with the determination of the functional requirements (section 7.1), in this phase accessible guidelines and the option to compare alternatives is more important than to assess absolute performance. Mainly because conducting simulations is a time-consuming and complex process. Providing the architect with indications of comfort contribution and energy performance may be helpful in order to make informed decisions on these aspects. However, in order to generate such indications, for example in the form of a rating, many simulations must be conducted first. After processing the outcomes the results can be incorporated into the knowledge base and presented to the architect, with the remark that it is vital to communicate conditions and restrictions that apply to the given indication in order to prevent misinterpretations.

The tool has a highly visual form with a structured layout in order to create an easy to understand navigation. Each of the four categories (principles, solutions, projects and guidelines) is represented with a unique colour that is used consistently throughout the tool. Sketches provide a quick concept of the given solution and icons are used to make associated energy sources, comfort provisions and energy treatments easy recognizable. This all answers to requirements #10 and #14.

The user can access the knowledge base from multiple starting points and navigate through the content in a random order to discover potential design solutions. The different presentation modes (i.e. matrix, catalogue, gallery and lists) also allow access to the content from any of the three different design orientations site, program and concept. All existing relationships between principles, solutions, projects and guidelines are communicated on both the different overviews and the info sheets. This allows the user to quickly jump to related content, while the browsers history makes it possible to trace back any step. This all helps the user to quickly access relevant knowledge. This all meets requirement #15. Combined with the use of sketches and exemplary project examples this would leave room to the architect to come up with creative ideas, answering to requirement #11.

The tool does not offer customisation options in its presented form, so requirement #12 is not yet met. However, advanced customisation is to be relatively easy incorporated since the structure of the tool is deliberately kept modular and flexible.

A way to validate the tool is to collect feedback from the intended group of users, the architects. In the next section feedback from architects that used the tool for some period is presented.

§ 7.4 Review by architects

Since the tool is aimed at architects, best is to allow architects to test the tool and provide feedback on the tool in general and more specific on the stated qualities of the tool. From their feedback improvements on user experience and user interaction can be implemented. This will eventually lead to a better embedding of the tool in the architect's workflow.

A total number of twelve architects, from twelve different firms, where asked to provide this feedback. The architects were invited based on a profile, namely employed at a relatively small firm and working on relatively small projects that are tightly bounded by time and budget. This ties to the focus of the tool as stated earlier in the research constraints in section 1.4. Although all approached architects responded positive, many of them said that they could not deliver in the given timeframe. From the following architects feedback has been collected:

- Job Schroën, September architectuur
- Arjen Spreeuwens, SPR. architectuurstudio
- Dennis Hauer & Eirini Sfakiotaki, Urban Climate Architects
- Tjerk van de Wetering & Freddie Slot, BYTR

Preferably, the architects used the tool when working on an actual design task. This proved to be difficult in the given timeframe, so as an alternative some architects used the tool on a recent design task or on a fictional or - for them - typical design task.

The architects were introduced to the tool in a 45 minute one-on-one session, after which they were presented with a short questionnaire, consisting of the following nine questions:

- 1 How valuable is information regarding climate-responsive design in the analysis phase?
- 2 How valuable is information regarding climate-responsive design in the generation phase?
- 3 How valuable can information regarding climate-responsive design be in other design phases, namely evaluation and implementation?
- 4 Which elements³¹ of the tool are most valuable to you?
- 5 Which elements of the tool are least valuable to you?
- 6 Which elements are missing?

31

Matrices, catalogue, info sheets, sketches, icons, qualitative information, quantified information, references, relationships between design principles and solutions, photo gallery, reference projects, guidelines and book-marks.

- 7 How valuable is the presented information regarding climate-responsive design in the generation phase?
- 8 How do you value the form of the tool?
- 9 How do you value the usability of the tool?

They were then asked to use the tool sometimes during the successive weeks after which a follow-up meeting was arranged to collect the feedback. The follow-up meeting was - in all but one case - in the form of an unstructured interview to allow for discussion and debate. The following outcomes³² can be deduced from the feedback:

- 1 The general opinion about the added value of having information on climate-responsive design in the early phases of the design process is acknowledged by all respondents. They find a quick scan of possible design principles useful and it will help them with establishing the starting points of the design's determining factors.
- 2 It is mentioned that the availability of the information may increase the chance on a integral design outcome, rather than seemingly employing design solutions as add-ons to the design.
- 3 The added value of climate-responsive design in the evaluation and implementation phase is acknowledged as well, but only if the information is made more specific (e.g. applicability, materialisation, dimensions, etc.) and quantified on relevant aspects, including energy performance, costs and pay-back time. Fundamental in the evaluation stage is the possibility of comparing this quantified information for different design solutions, in an easy to read visual style. It was stated multiple times that there was no trace of these elements in the tool, and thus making the tool in its current form not useful in these design phases.
- 4 The matrices of design principles and solutions were identified as valuable elements of the tool. The matrices give a quick to read bundled overview of possibilities. The projects overview was also mentioned as a valuable element, since it allows for a quick scan of the visual impact of different design solutions. With respect to the form of the project overview, some architects would find it more useful if archetypes are shown, while others rather see a collection of good and bad examples.
- 5 The guidelines were mentioned as a less valuable element of the tool. It was mentioned that this may be due to its execution. The design guidelines were tucked away and could hardly be used during decision support. It was mentioned that the guidelines would benefit more from a presentation in the form of a roadmap. Also the bookmarks were mentioned as less valuable in its current form since it is merely a repetition of information and is still presented in bulk, which makes it feel as an information overload. The bookmark function would be much improved if only selective parts of the information could be bookmarked instead of principles, solutions or projects in their entirety.

32

It was agreed upon the anonymous presentation of the architect's feedback, in order to make it impossible to trace back answers to individual persons.

- 6 A more visible presentation of combined design solutions was identified as a valuable but yet missing element of the tool. Although synergetic and conflicting effects are part of the tool, they are tucked away and only communicated as a remark. It was mentioned it would be more helpful if such synergetic effects were a more prominent part of the tool and presented in a highly visual style, including examples. Furthermore it was mentioned that a more concentrated comparative analysis among selected design solutions was considered vital for the tool to become helpful as design-decision support. The pros and cons of a design solution are only presented within the individual info sheets and can by no means be directly compared to other design solutions.
- 7 The offered information was considered valuable and forces the architect to think ahead. However, it was mentioned that the presented information is not per se directive or defining in the design process. It was mentioned that this could be achieved by offering more deepened and stratified information in the form of schemes and drawings.
- 8 It was also mentioned that the tool has potential to be used as a communication tool when presenting design ideas to clients. On the condition that the knowledge base is expanded with more illustrative examples in photos, schemes and drawings.
- 9 The tool was in general considered user-friendly since it is organised, well structured and has a recognisable visual style. The tool as a collection of climate-responsive design principles and solutions was considered valuable since it gives the architect a head start on the topic and will limit the need of studying the topic by consulting a number of other sources, such as books, magazines and websites. However, at the moment the tool sometimes presents a lot of descriptive information in bulk and can therefore become too much to handle. This forces the architect to spend more time studying the presented information, which slows down the design process. Architects mentioned that the readability of the information will improve when presented as an enumeration where possible and that the usability of the tool will benefit from the use of filters that limit the presented information only relevant to the design task ahead and a more layered presentation of detailed information. Furthermore, valuable elements (i.e. matrices) and key information (i.e. pros and cons) were sometimes considered as hidden and should be presented more prominently, more directly and more specifically.

These findings form a good basis for suggestions to improve the tool, together with the findings from section 7.3. The suggestions for future development of the tool are presented in the next section.

§ 7.5 Discussion

As mentioned earlier, the presented concept tool is meant to be a working concept of a support tool. The intention never was to deliver a final product. The knowledge base is not filled with content in all areas and some of the desired functions were not implemented in the presented concept.

Drawn from the tool requirements (section 7.1) and complemented by the feedback given by architects that used the tool (section 7.4), the following suggestions for future development can be identified:

- 1 A more streamlined presentation of primary and related secondary content on the info sheet, by switching from the current column-based setup (Figure 7.16, 1) to a row-based setup (Figure 7.16, 2). This includes for example the presentation of project examples in the sidebar directly alongside the main content block architecture, and the presentation of the guidelines directly alongside the main content block process.
- 2 The presentation of knowledge using different layers of detail, by starting to provide a concise overview (e.g. guidelines, synergetic and conflicting effects and applicability) and giving the user access to more specific content (e.g. background information, properties and performance) on demand. To manage the amount of information displayed at once, an expand/collapse layout (Figure 7.16, 3) or a tab-based layout (Figure 7.16, 4) improves the readability.
- 3 A more prominent, direct and visual approach to synergetic and conflicting effects. Show the architects how to benefit from synergetic effects and how to overcome possible conflicts by project examples and detailed schemes and sketches. Complement synergetic effects with exemplary projects that successfully combine multiple solutions (Figure 7.16, 5).
- 4 The extension of the project examples with more detailed information, schemes, drawings, performance and lessons learned. This can be achieved by creating a closer linkage to existing (online) resources that already bundle more detailed project information (e.g. wikiarquitectura).
- 5 The implementation of more context-specific content will speed up the process of developing an energy concept and improve the outcome. Examples of relevant context-specific content are building type (e.g. detached house, row house, flat), building scale (e.g. single unit, housing block, low-rise, high-rise) and setting (e.g. urban, rural), among others.
- 6 The introduction of filters for setting project-specific conditions (e.g. plot size, orientation, maximum building height) in order to limit the amount of information presented only to the relevant bits (Figure 7.16, 6).
- 7 A more concentrated and visual approach for the comparison of different design solutions. This could for example include a side-by-side presentation of user selected design solutions (Figure 7.16, 7).

- 8 A more selective approach to the bookmarks in order to limit the amount of bookmarked information only to the relevant bits (Figure 7.16, 8).
- 9 The widening of the scope of the knowledge base with the inclusion of more dedicated knowledge of the urban microclimate and its effects on natural energy potential of the built environment.

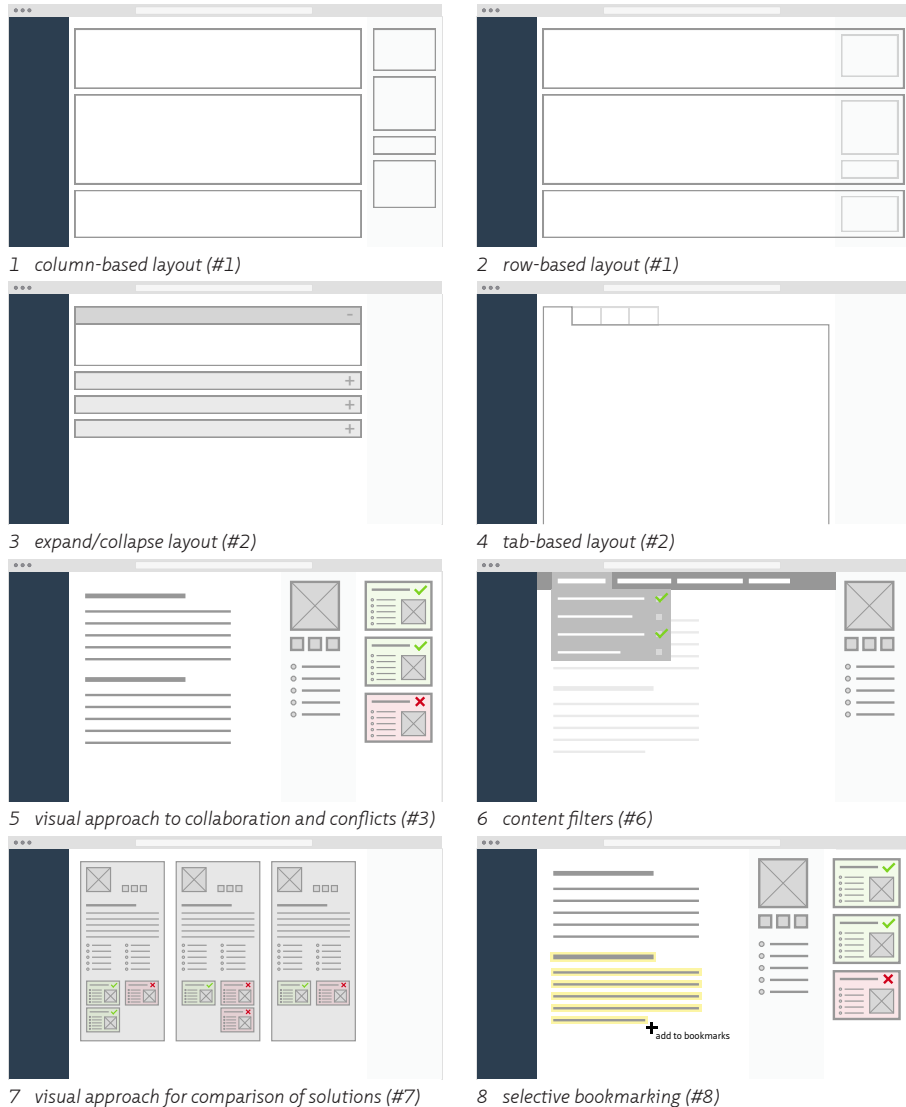

FIGURE 7.16 Sketches to illustrate future development of the tool.

As with any knowledge base it is essential to keep the content up to date. It is unlikely that the content will become outdated on a short term, but complementary knowledge, new insights, new solutions and example projects that are relevant to climate-responsive design must be added to the knowledge base to keep the tool relevant. The tool can benefit from the contribution of experts on both correcting and complementing the knowledge base. Maintaining these kinds of knowledge bases is probably best outsourced to a knowledge institute or a dedicated organisation with expert contributions.

The presentation of a working concept of the design-decision support tool, its review by architects and the enumeration of suggestions for the improvement and future development of the tool brings the end of this research in sight. In the final chapter 8 the research questions will be revisited.

References

- Attia, S., Hensen, J.L.M., Bertran, L. and De Herde, A. (2012a) Selection criteria for building performance simulation tools: contrasting architects' and engineers' needs in *Journal of Building Performance Simulation*, vol. 5, nr. 3, pp. 155-169.
- Attia, S., Gratia, E., De Herde, A. and Hensen, J.L.M. (2012b) Simulation-based decision support tool for early stages of zero-energy building design in *Energy and Buildings* 49 (2012) 2-15.
- Ellis, M.W. and Mathews, E.H. (2002) Needs and trends in building and HVAC system design tools in *Building and Environment* 37 (2002) 461-470.
- Erbas, I. and Van Dijk, S. (2012) A survey for the improvement of decision support tools for effective sustainable architectural design in *International Journal of Sustainable Building Technology and Urban Development* Vol. 3, No. 4, December 2012, 294-305.
- Hensen, J. (2004) Towards more effective use of building performance simulation in design in *Proceedings of the 7th International Conference on Design & Decision Support Systems in Architecture and Urban Planning*, Eindhoven, The Netherlands.
- Kanters, J., Horvat, M. and Dubois, M. (2014) Tools and methods used by architects for solar design in *Energy and Buildings*, Volume 68, Part C, January 2014, Pages 721-731.
- Shaviv, E. (1999) Design tools for bio-climatic and passive solar buildings in *Solar Energy* Vol. 67, Nos. 4-6, pp. 189-204, 1999.
- Yezioro, A. (2009) A knowledge based CAAD system for passive solar architecture in *Renewable Energy* 34 (2009) 769-779.

8 Conclusions and recommendations

With the proposal of a working concept for a support tool for climate-responsive design in the previous chapter this research project reached its completion. In conclusion, in this final chapter the main research question will be answered, complemented with research findings and recommendations for further research.

In chapter 1 the following main research question was stated:

How can architects fully exploit the potential of natural energy sources within the built environment in their process of designing comfortable low-energy dwellings using climate-responsive building elements?

This main question will be answered by answering the stated sub research questions first, one by one.

§ 8.1 Revisiting the research questions

1 ***How can knowledge on climate-responsive design best be made available to the architect?***

Building a knowledge base on climate-responsive design by itself does not guarantee proper interpretation and implementation by the architect. Any knowledge should be presented to the architect in the right language. Choosing the right language requires understanding of how the architect thinks and works. The aspects of creativity, intuition and visualisation in design are relevant in order to provide the background for the presented knowledge transformation.

The creative design process consists in general of the following phases:

- analysis
the exploration of possibilities and limitations
- generation
the actual process of conceptual design with the generation of design options; valid solutions to the problem (or need)
- evaluation
evaluation of design options
- communication or implementation
the selection of the preferred design option and the basis for the final design

Although experts can be introduced to the design process, in practice specific expertise is sparsely used or can often not be called upon during the early design stages of analysis and concept development. In those cases architects need to make decisions on climate-responsive design on their own. The architect is then best served if the knowledge is available as informative support during decision making when laying out the energy design concept.

Following Kolb's different learning styles a design support tool is found to be best presented in a normative style - when focusing on mainstream architectural practice - while addressing different design orientations (program, concept and site) as possible starting points of design.

2 ***What are the comfort and energy demands in relation to climate-responsive design?***

What is defined as comfortable has far-reaching implications for the way buildings are designed and how indoor environments are maintained. The urge to fully control the indoor environment has resulted in the widespread dependence on mechanical climate control systems. Such systems operate almost completely separately from the building and are almost indifferent to their environment. The more adaptive approach to comfort provision tends towards an indoor thermal environment that is attuned to the dynamics of the outdoor environment.

Through climate-responsive design a building becomes an intermediary of occurring natural energy flows and reconnects the user to the outdoor environment. The employment of the ability of structural and architectural elements to play an active role in the harvesting and harnessing energy flows, the so-called climate-responsive building elements, fulfil a link in the development of an energy design concept.

Many spatial, functional and comfort-related conditions that are written down in the design brief affect the energy concept of a design. As many of these boundary conditions may already have a major influence on the energy concept of a design, their identification is fundamental to climate-responsive design. The conditions and their effect on the energy design concept were identified in section 3.3 and are repeated in [Table 8.1](#) and [Table 8.2](#).

BOUNDARY CONDITION	DESCRIPTION	DESIGN CONSIDERATIONS
site selection and planning	The energy potential of one site may be better fit for a certain design problem than the other. However, in many design cases the plot is already decided for by the principal. This only leaves site-specific energy potential of the selected site to the architect.	<ul style="list-style-type: none"> - Consideration of site specific features such as plot orientation, situation (urban or rural) and potential of (existing) landform and vegetation.
building density	The total amount of units on a certain plot. With higher densities more units need to benefit from the same energy potential.	<ul style="list-style-type: none"> - Increased densities require more stringent measures on reducing energy demand. - Higher densities allow sharing of design solutions that can boost effectiveness as opposed to when applied on the scale of a single building unit. - Higher densities allow (more) cost-effective application of shared solutions.
organisation and stacking of dwellings	For example, apartment building, terraced dwellings or detached house. The dwelling type determines the ratio between specific areas of the building skin (ground floor, façade, roof) available for energy harvest.	<ul style="list-style-type: none"> - Apartments have a low unit-specific surface exposed to ambient conditions, no specific surface to the soil and large surface adjacent to other apartments. Energy is therefore particularly to be harvested at the façade or through communal systems. - A detached house has large surfaces exposed to ambient conditions, a significant surface exposed to the soil and no surface adjacent to other buildings. This makes that energy can be harvested virtually from any side of the building. However, as a result, the large effective heat loss area requires special attention to limit energy losses.
target group	Human presence and related comfort requirements differ from group to group: families with children, two-income couples with no children, single persons, elderly, etc.	<ul style="list-style-type: none"> - Elderly spend most time indoors and require a smaller band width in which the comfort zone may vary. This would put more emphasis on sustained retention of certain comfort levels. - Two-income families with no children and single persons use the house (and its living spaces) more intermittently, which would benefit more from a decentralized demand-driven comfort control strategy. - Families with children will use the house more continuous, occupying different zones at the same time. This would call for an individual operable demand-driven control strategy.
price range	The price range of the development (e.g. social housing or penthouses) partly set the available budget for comfort-control related investments.	<ul style="list-style-type: none"> - Future occupants of social housing projects are best helped by low operational costs. - Development of more expensive dwellings give an opportunity to apply more expensive solutions.

TABLE 8.1 Spatial and functional boundary conditions and their effect on the energy concept.

COMFORT-RELATED PARAMETER	DESCRIPTION	DESIGN CONSIDERATIONS
Thermal comfort requirements and target values (traditional vs. adaptive)	Determines the general heating and cooling strategy.	<ul style="list-style-type: none"> – Tune passive heating strategies to the heating demand, thus optimize for the times most needed, and complement with strategies of conserving or storing energy. – Group zones with similar requirements and position them in the building plan (orientation, floor level) according to the energy offer.
Summer comfort	Strategies to prevent and overcome issues of overheating.	<ul style="list-style-type: none"> – Prevent issues of overheating by keeping heat out or accelerated discharge of gained heat. – Apply passive cooling strategies using lower temperature sources in the surroundings.
Air quality requirements (e.g. maximum CO ₂ concentration)	Ventilation strategy: when and where to ventilate.	<ul style="list-style-type: none"> – Eliminate contamination sources as much as possible. – Employ demand-control ventilation: design for decentralized ventilation with heat recovery in cold periods.
Humidity requirements	Defines humidity-control measures.	<ul style="list-style-type: none"> – Moisture buffering strategies (e.g. hygroscopic interior wall and ceiling finish) is a supplement to typical control strategies based on ventilation. – Buffering techniques enable moisture control spread over time, eliminating the need for direct increased ventilation and possible accompanying issues of discomfort.
Acoustic requirements	Acoustical behaviour of elements and finishes	<ul style="list-style-type: none"> – Unobstructed flow of (ventilation) air throughout the building should match requirements on noise levels.
Illumination requirements	Defines window size and arrangement, glare protection measures and privacy control.	<ul style="list-style-type: none"> – Allowance for sufficient daylight admission in tune with heat transfer (solar access and transmission losses). – Special attention to daylight admission is needed in densely built environments. Highly placed windows can be more effective.
User intervention	Adaptive control measures	<ul style="list-style-type: none"> – Although it sometimes may seem that adaptive control measures are in conflict with a low-energy strategy, this is not per se true since adaptive control measures improve comfort experience and the acceptance of short-term deviations. A valid climate-responsive concept is able to minimise the negative energy effects of user intervention. In addition users can be made aware of the energy and comfort impact of their actions.

TABLE 8.2 Comfort-related boundary conditions and their effect on the energy concept.

3 What is the potential of natural energy sources within the built environment?

In chapter 4 the energy offer of the climate resources (e.g. sun and sky, earth, wind, and water) in context of local climate and the influence of the urban microclimate was researched. The presence of urban tissue and other elements such as water and

vegetation has an effect on the microclimate which can be significantly different from local climate as it would be without the presence of such elements. Such factors should be taken into account when calculating the energy potential of a built environment.

In the light of climate change, it was discussed that due to the expected changes in climate (e.g. solar radiation, temperature, precipitation and wind) - in accordance with KNMI's climate scenarios - emphasis shifts to cooling, or the prevention of overheating. These changes in energy offer of climate resources and comfort demands determine the climate-responsive design strategy to be followed.

In this study some heavily related environmental parameters with a strong effect on the development of the energy concept were derived (section 4.4, repeated in [Table 8.3](#)).

ENVIRONMENTAL PARAMETER	POINTS OF PARTICULAR ATTENTION
Urban pattern, vegetation and solar geometry	<ul style="list-style-type: none"> - Solar access to building envelope (shadow casting, etc.) determines potential for passive and active solar strategies. In densely built areas solar harvest is limited at levels of the building skin low to the ground. The uppermost storeys and the roof can still be well exposed to the sun. - On-site vegetation can block sun access to the building, which can be beneficial to the purpose of solar shading.
Urban pattern, landform, vegetation and distribution of wind direction and speed	<ul style="list-style-type: none"> - Wind behaviour in urban canyon and urban canopy determines potential for natural ventilation and wind power. A high density causes natural air to flow over the building rooftops, while limiting the air flow at street level. - When no clear prevailing wind direction is available wind is best harvested using a strategy that is able to 'catch' wind from different directions. - Landform and vegetation may block wind access to the building, which can be beneficial to the purpose of wind screening.
Annual temperature distribution, soil composition and ground cover	<ul style="list-style-type: none"> - Energy exchange potential of shallow layers of the soil. Soil composition and (soil) temperature at shallow depths follows seasonal trends in air temperature of the location. Directly underneath the building the energy balance is also fed by heat flows from the building.
Average annual temperature, soil composition and groundwater flows	<ul style="list-style-type: none"> - Energy storage potential of deeper layers of the soil. Soil temperatures at depths of 10 m and more are quite stable and close to the average annual air temperature at the location. In addition, groundwater flows affect the energy balance of the soil, either boosting or blowing the heating (or cooling) potential for prolonged periods.
Air temperature distribution (extreme values, mean values) and solar geometry	<ul style="list-style-type: none"> - Primary steering factor of general thermal energy balance of the building. Use a quick-scan method to explore heating and cooling demands of an initial design.
Solar path in periods with high chance on overheating	<ul style="list-style-type: none"> - By using a quick-scan method the need for preventive measures according to the time of year and time of day can be mapped. - Fixed shading devices then block the solar radiation from corresponding sun angles.
Natural light access to the envelope	<ul style="list-style-type: none"> - Strategic use of daylight minimise the need for additional electric lighting.
Water presence, whether or not combined with vegetation	<ul style="list-style-type: none"> - The presence of water has a cooling effect on the direct surroundings due to the effect of evaporation.

TABLE 8.3 Climate-related and context-related boundary conditions and points of particular interest in the development of an energy concept.

4 **What are the underlying principles of climate-responsive design and how can they be transformed into actual design solutions?**

Climate-responsive design enables the potential of buildings to act as an intermediary between the indoor and outdoor environment. By doing so, a comfortable indoor environment can be created that is in tune with the dynamics of the outdoor environment. Following the human preference for diversity this can have a positive effect on health.

Comfort demands, local climate and building design together determine to a large extent the energy use of buildings. Local climate is also inextricably connected to low energy design when considered as a potential energy source instead of a threat. Based on the principles of bioclimatic design, climate-responsive design is not a one size fits all design solution but aims to be a balance between architecture and an high energy performance. Key aspects of climate-responsive design are comfort provision, the building as a responsive system and energy exchange with the environment.

Next to the promotion and prevention of energy exchange climate-responsive design employs complementing energy treatment strategies such as energy conservation, distribution, buffering, recovery and storage. Climate-responsive buildings can combine multiple design solutions that together result into a comfortable building with an effective energy balance primarily fed by natural energy flows (Figure 8.1). The design strategy to follow and the effectiveness of chosen solutions depend on local climate conditions and the intended building use.

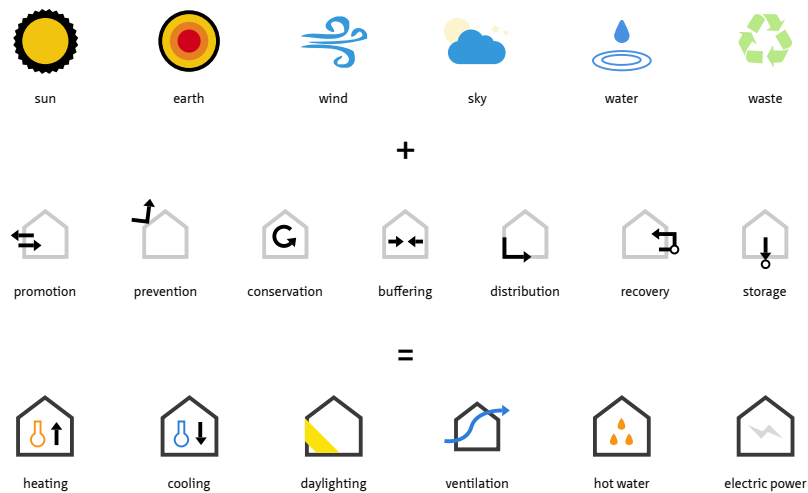















FIGURE 8.1 The energy balance of a climate-responsive building where the harvest of natural energy sources and complementing energy treatment strategies provide the energy needs for comfortable living.

Many comfort aspects can be met directly from harvesting or diverting natural energy flows, while others use some energy treatment strategy. The different design principles were schematically presented in two matrices and shortly described in section 5.4.1. The matrix of climate-responsive design principles presented as comfort provision against energy treatment is repeated here (Table 8.4).

	 heating	 cooling	 daylighting	 ventilation	 hot water	 electric power
 promotion	passive solar heating earth coupling	earth coupling natural cooling	natural illumination	natural ventilation	solar hot water geothermal hot water	solar power wind power
 prevention		solar shading	solar shading			
 conservation	thermal conservation	thermal conservation				
 buffering	thermal buffering	thermal buffering				
 distribution	thermal distribution	thermal distribution	daylight distribution			
 recovery	transmission heat recovery ventilation heat recovery				effluent water heat recovery	
 storage	thermal energy storage	thermal energy storage			hot water storage	

- Ventilation heat recovery is about recovering valuable heat from stale air flows. It is therefore part of a heating strategy and not of a ventilation strategy.
- Effluent water heat recovery is about recovering valuable heat from waste water flows. Since in current practice the recovered heat from effluent water streams is directly transferred to fresh water streams it is here categorized as a strategy for the provision of domestic hot water.

TABLE 8.4 Matrix of climate-responsive design principles presented as comfort provision against energy treatment.

From these design principles a collection of climate-responsive design solutions was composed. The climate-responsive design solutions are divided into three main categories (i.e. contextual, architectural or technical) and into six subcategories that cover various dimensions in planning and construction (i.e. site planning, building form and layout, building skin, building structure, building finish and (integrated) building services) (Figure 8.2).

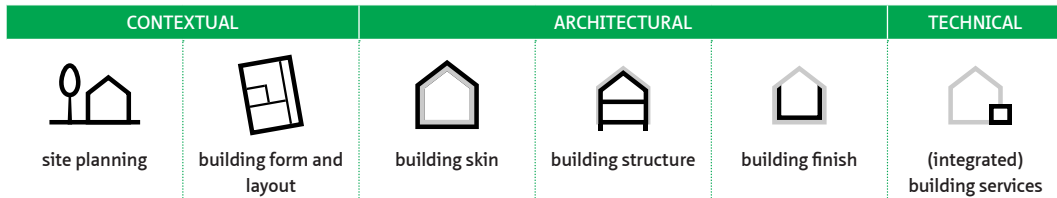







FIGURE 8.2 Categorization of climate-responsive design solutions into contextual, architectural and technical solutions.

A non-exhaustive overview of climate-responsive design solutions, categorised according to the predominant underlying design principle and the solution type (i.e. contextual, architectural or technical) was presented in section 5.4.2 and is repeated here (Table 8.5).

	CONTEXTUAL		ARCHITECTURAL			TECHNICAL
	 site planning	 building form and layout	 building skin	 building structure	 building finish	 (integrated) building services
passive solar heating			direct solar gain system sun space	thermal storage wall		warm air collector
solar shading	shading from on-site vegetation		switchable window system + external solar shading light shelf +	structural shading device	printing	
natural ventilation			solar chimney wind catcher			
natural illumination			switchable window system + translucent insulation +			light pipes optical fibres
solar hot water						solar thermal collector
solar power						photovoltaic cell
night-sky cooling						
natural air cooling	cooling from shaded areas cooling from water bodies					
wind power						urban wind turbine
earth-coupling	earth shelter +		earth shelter +	direct contact foundation slab energy piles absorber diaphragm wall foundation slab with absorber lines		deep-layer earth coupling + ground-coupled ventilation
geothermal hot water						deep-layer earth coupling +
evaporative cooling			roof pond			
thermal conservation		air lock airtightness compact design thermal zoning wind screening	adaptable insulation thermal shutter translucent insulation +			
thermal buffering				thermal mass thermo-activation +	phase change material	

>>>







	CONTEXTUAL		ARCHITECTURAL			TECHNICAL
	 site planning	 building form and layout	 building skin	 building structure	 building finish	 (integrated) building services
thermal distribution			cavity wall heating	hollow core ventilation thermo-activation +		
daylight distribution			light-redirecting window system light shelf +			optical fibres
transmission heat recovery			boundary wall heat recovery dynamic insulation			
ventilation heat recovery						breathing window
grey water heat recovery						
thermal energy storage						
hot water storage						

TABLE 8.5 Overview of climate-responsive design solutions, categorised according to the (predominant) underlying design principle(s) and the solution type (contextual, architectural or technical). Solutions marked with a + occur more than once in the matrix.

The main focus in this research is on climate-responsive building elements - design solutions within the architectural design solution categories building skin and structure - characterized by a far-reaching integration of energy harvest methods into structural and architectural elements. They were discussed in section 5.4.3 and is repeated here (Table 8.6).





	building skin				building structure			
		opaque façade	transparent / translucent façade	roof	subsurface foundation elements	ground floor slab	column / beam	load bearing wall / floor
 heating	promotion provide space heating	cavity wall heating thermal storage wall / Trombe wall	direct solar gain system sunspace	solar attic	energy piles absorber diaphragm wall	thermal mass foundation slab with absorber lines	thermo-activation	thermal mass thermo-activation
	prevention heat loss limitation	adaptable insulation	thermal shutter translucent insulation	adaptable insulation	-	adaptable insulation	-	
 cooling	promotion provide space cooling	earth shelter	-	roof pond	energy piles absorber diaphragm wall	direct contact foundation slab foundation slab with absorber lines earth shelter	thermo-activation	thermo-activation
	prevention overheating prevention		light shelf switchable window system		-	thermal mass	-	structural shading device thermal mass
 ventilation	promotion enforce natural energy flows	solar chimney	-	solar chimney wind catcher	-	-	-	-
	distribution / recovery precondition ventilation air	dynamic insulation	-			hollow core ventilation	hollow core ventilation	hollow core ventilation
 daylighting	promotion / prevention / distribution control comfortable amounts of daylight	-	light shelf switchable window system translucent insulation	structural shading device	-	-	-	structural shading device

TABLE 8.6 Matrix of climate-responsive building elements.

Based on the theoretical framework as presented in chapter 2 and the gathered and generated knowledge in chapters 3, 4 and 5, the following content requirements for the design support tool were formulated in section 5.5:

- **Performance**
the comfort contribution and energy performance
- **Process**
the collaborations and conflicts of combining solutions, and the possible energy function of a building element
- **Architectural consequences**
the impact of climate-responsive building elements on the appearance of design

These content requirements were given interpretation by the research conducted in chapter 6.

5 ***What specific knowledge on climate-responsive design solutions is needed to fill the design support tool?***

In chapter 6 the information meeting the content requirements as stated in section 5.5 was generated for a selection of climate-responsive building elements. Hereafter, a resume of the gathered knowledge is answers to this sub question.

Comfort contribution and energy performance

Quantified results on comfort contribution and energy performance merely give an indication and are very specific for the considered design options. This makes comparison of outcomes for the purpose of selecting design solutions based on their contribution or performance difficult. Moreover, conditions and restrictions apply to the presented quantification and may result in misinterpretations if not communicated well enough. The provision of meaningful indications of comfort contribution and energy performance for climate-responsive design solutions is considered beyond the scope of this research, mainly because of its time-consuming and complex nature.

Identification of synergetic and conflicting effects

Most design principles and solutions will operate next to each other without interfering with their individual performance. Some have great opportunity of improved overall performance through collaboration, but some combinations require special attention in the design process in order to prevent conflicts in the final design which can reduce overall performance significantly. The key is to be aware of the possible conflicts in an early stage in order to come up with creative solutions to gain in overall performance of the design. Possible conflicts and synergetic effects were collected in section 6.10 and repeated here in [Table 8.7](#) and [Table 8.8](#).

POSSIBLE CONFLICTS	EXPLANATION / CLARIFICATION	DESIGN CONSIDERATIONS
Flexibility of layout vs. thermal zoning	A flexible layout leaves the planning of the dwelling to the occupant. This implies that all zones need to be able to fulfil a variety of comfort demands, including the one's with the highest standard. Opposed to a thermal zoning concept where it should be clear to the occupant if a zone is meant to fulfil a specific purpose in the energy concept that makes it not eligible for flexible use (e.g. a sun space that is transformed into an all-year round living space and therefore reduces overall performance).	-
Compact design vs. daylight admission and natural ventilation potential	Compact building design is highly functional while routing stays minimal and highly efficient from a thermal conservation point of view. However, compact design may conflict with sufficient daylight admission and the potential of using natural ventilation techniques.	- Use skylights to improve the quality of natural light into the building. Harvest undisturbed wind flows that pass over the building roof.
Flexibility of layout vs. strategies for natural ventilation and passive cooling	Natural ventilation and passive cooling strategies require a matching layout. The flexibility of the layout should be taken into account in order to prevent the need for technical installations when building use changes.	- Natural ventilation flows benefit from unobstructed paths and are enforced by sufficient height differences.
Thermal buffering vs. natural illumination	Massive building elements to improve the building's thermal quality by buffering energy may interfere with desired levels of transparency for daylight admission and views to the outside.	- Adopt floor structures and/or interior wall elements for thermal mass. - Choose PCM as an alternative.
Natural illumination vs. solar shading	Careful design of measures that guarantee daylight admission and outside view in compliance with solar shading, glare protection and privacy issues.	- Use solutions that are able to meet multiple requirements. These solutions can be either non-adaptable such as light shelves or adaptable in the form of movable or foldable sun shades, or louvres.
Active solar design vs. passive solar design	A ray of sunlight can typically only be used once. Smart selection optimises both active solar gains (e.g. photovoltaics or thermal collectors) and passive solar gains (e.g. passive solar heating, natural illumination).	- Deploy both active and passive solar design strategies close(r) to comfort demands to be met (e.g. solar hot water in the morning, solar power after works hours, etc.).

TABLE 8.7 An overview of possible conflicts in the development of the climate-responsive design concept.

DESIGN PRINCIPLE THAT HAS AN OPPORTUNITY TO COLLABORATE	EXPLANATION AND CONSIDERATIONS
passive solar heating and thermal energy storage	– The overcapacity of ‘over-sized’ (i.e. generating more energy than directly required) passive solar heating solutions can be stored for later use.
passive solar heating and thermal buffering	– The overcapacity of ‘over-sized’ (i.e. generating more energy than directly required) passive solar heating solutions can be buffered for use after the sun sets and ambient temperatures may drop significantly.
passive solar heating and solar driven ventilation	– Trombe wall systems where air filled cavities are heated by solar radiation can be partially employed as solar chimney.
solar shading and thermal conservation	– When solar shading devices are designed in such a way that they can be placed in front of a window, they can function as additional thermal insulation when needed.
solar shading and solar power	– Since a shading device’s primary task is to prevent windows to be exposed to solar radiation, they can be equipped with photovoltaic cells to harvest solar energy instead of rejecting it.
natural ventilation and earth coupling	– In colder periods when ventilation air drawn directly from outside could cause issues of draught. To prevent this, a solar or wind-driven ventilation system can be connected to a ground-coupled ventilation system that preconditions the fresh ventilation air.
solar driven ventilation and natural air cooling	– The need for cooling follows the solar offer to a large degree. Solar-driven ventilation flows can therefore be applied to draw cool air in for passive cooling purposes.

TABLE 8.8 An overview of opportunities for collaboration between climate-responsive design principles.

Possible energy function of climate-responsive building elements and their primary (or other) function

The selection of design elements should aim for their contribution to the energy concept, but may not interfere with the fulfilment of their primary functions such as safety and functionality. An overview of the hidden energy purpose of building components, supplementary to their primary function(s) was presented in section 6.10 and is repeated here (Table 8.9).

COMPONENT	PRIMARY FUNCTION(S)	HIDDEN ENERGY PURPOSE(S)
building site	<ul style="list-style-type: none"> - accessibility - outdoor space 	<ul style="list-style-type: none"> - improvement of microclimate through vegetation and water bodies - shading from vegetation - wind protection
staircase	<ul style="list-style-type: none"> - internal routing 	<ul style="list-style-type: none"> - increase height difference to enforce natural ventilation potential
hallways	<ul style="list-style-type: none"> - internal routing 	<ul style="list-style-type: none"> - thermal distribution - thermal buffer zone
attic	<ul style="list-style-type: none"> - storage space - additional living space 	<ul style="list-style-type: none"> - solar collection - internal heat collector (from rising warm air)
construction pile	<ul style="list-style-type: none"> - building support 	<ul style="list-style-type: none"> - earth coupling
ground floor slab	<ul style="list-style-type: none"> - building support 	<ul style="list-style-type: none"> - thermal mass - direct earth coupling
basement	<ul style="list-style-type: none"> - utility and storage space 	<ul style="list-style-type: none"> - energy storage facility
load bearing wall	<ul style="list-style-type: none"> - building support 	<ul style="list-style-type: none"> - thermal mass - thermo-activation
column	<ul style="list-style-type: none"> - building support 	<ul style="list-style-type: none"> - thermo-activation
beam	<ul style="list-style-type: none"> - building support 	<ul style="list-style-type: none"> - thermo-activation
floor	<ul style="list-style-type: none"> - building support - internal organization of spaces - storey separation - fire protection 	<ul style="list-style-type: none"> - thermal mass - thermo-activation
external wall	<ul style="list-style-type: none"> - shelter 	<ul style="list-style-type: none"> - microclimate improvement from green walls - thermal conservation
window	<ul style="list-style-type: none"> - daylight admission - natural ventilation - outdoor view 	<ul style="list-style-type: none"> - thermal conservation - direct solar heating
roof	<ul style="list-style-type: none"> - shelter - rainwater drainage 	<ul style="list-style-type: none"> - microclimate improvement from green roofs - thermal conservation - roof pond - solar attic
internal wall	<ul style="list-style-type: none"> - internal organization of spaces - room separation - fire protection 	<ul style="list-style-type: none"> - thermal mass
ceiling	<ul style="list-style-type: none"> - aesthetical feature 	<ul style="list-style-type: none"> - surface characteristics for optimization of daylight, thermal mass and acoustics
floor covering	<ul style="list-style-type: none"> - aesthetical feature 	<ul style="list-style-type: none"> - surface characteristics for optimization of daylight, thermal mass and acoustics

TABLE 8.9 An overview of the hidden energy purpose of building components, supplementary to their primary function(s).

Impact of climate-responsive building elements on the appearance of design

Some climate-responsive solutions have significant impact on the appearance of design, while others don't. The architect can select design solutions in order to create distinguished architectural designs. An overview of the (in)visibility of the design solutions was presented in section 6.10 and is repeated here in Table 8.10.

DESIGN PRINCIPLES	DESIGN SOLUTIONS	IMPACT ON APPEARANCE OF DESIGN	
		visible	invisible
thermal conservation	adaptable insulation	✓	✓
	thermal shutter	✓	
	translucent insulation	✓	
	dynamic insulation		✓
thermal buffering + thermal distribution	thermal mass		✓
	thermo-activated building elements		✓
	cavity wall heating		✓
	ventilated hollow core elements		✓
passive solar heating	direct solar gain		✓
	thermal storage wall	✓	
	sun space	✓	✓
	roof pond	✓	✓
earth-coupling	direct-contact foundation slab		✓
	earth shelter	✓	
	energy piles		✓
natural illumination	light-redirecting window system	✓	
	switchable window system	✓	
	light shelf	✓	
natural ventilation	solar chimney	✓	✓
	wind catcher	✓	
solar shading	structural overhang	✓	

TABLE 8.10 An overview of the visual impact of climate-responsive elements on the design. visible elements are clearly distinguishable and can, if desired, be designed as an architectural feature, whereas 'invisible' elements don't appear different from the 'ordinary' building elements.

6 **What is the best form for a design-decision support tool to transfer knowledge on climate-responsive design to the architect?**

In the early stages of the design process climate-responsive design is mainly about the generation of energy concepts, in which unequivocal guidelines and comparison of alternatives is more valuable than the assessment of absolute performance. The aim of the design support tool is to provide informative, context-specific knowledge that will assist the architect in generating design options.

The following key elements of the tool - split into requirements for content, function and form - were listed in section 7.1, and are repeated here:

Content requirements

- 1 the comfort contribution and energy performance of a design solution;
- 2 the possible disagreements between the employment of the energy function of climate-responsive building elements and their primary (or other) function;
- 3 the identification of collaborations and conflicts when using multiple design principles together;
- 4 the impact of climate-responsive building elements on the appearance of design.

Functional requirements

- 5 include a knowledge base with expert knowledge and best practice examples
- 6 provide informative, context-specific knowledge
- 7 provide accessible guidelines
- 8 provide the option to compare alternatives
- 9 include the ability to inform during and assist in decision-making (i.e. intelligence)
- 10 limit complexity and generate easy to interpret output

Form requirements

- 11 enable or give room to creativity
- 12 offer customisation options
- 13 prevent misinterpretation through proper guidance
- 14 present in a visual style
- 15 allow custom navigation patterns

Deduced from these requirements it was inferred that the support tool is best met using a web-based tool. This has the advantage of always up to date information and features accessibility from any device connected to the internet, the inclusion of custom navigation patterns, the inclusion of context-specific and custom filters, highlighting relationships to relevant parts of the knowledge base, and a bookmarking system in order to save relevant bits of the knowledge base for future reference.

An extensive preview of how the tool could function and look like was given in chapter 7, and is available online at <http://www.climate-responsivedesign.nl/tool>. The goal of this concept is to present some of the elements of the tool, illustrate in what ways the user can navigate through the knowledge, and in what ways the interrelationships between different content parts within the knowledge base are shared with the user. Since it is a concept it does not contain all content or desired functions. It is not meant to be a final product.

The heart of the tool is formed by the knowledge base, constructed from items grouped into one of four categories: principles, solutions, projects and guidelines. The most detailed presentation style of stored content per item is through **info sheets**. Other presentation styles include overviews in the form of a **catalogue**, a **matrix**, and an image **gallery** (projects only). These overviews give a quick look for all items in a category (with the exclusion of the guidelines) and reveal direct relationships to similar items (solutions only) and connected items from the other categories. Figure 8.3 shows an schematic overview of the different relationships between items in the knowledge base.

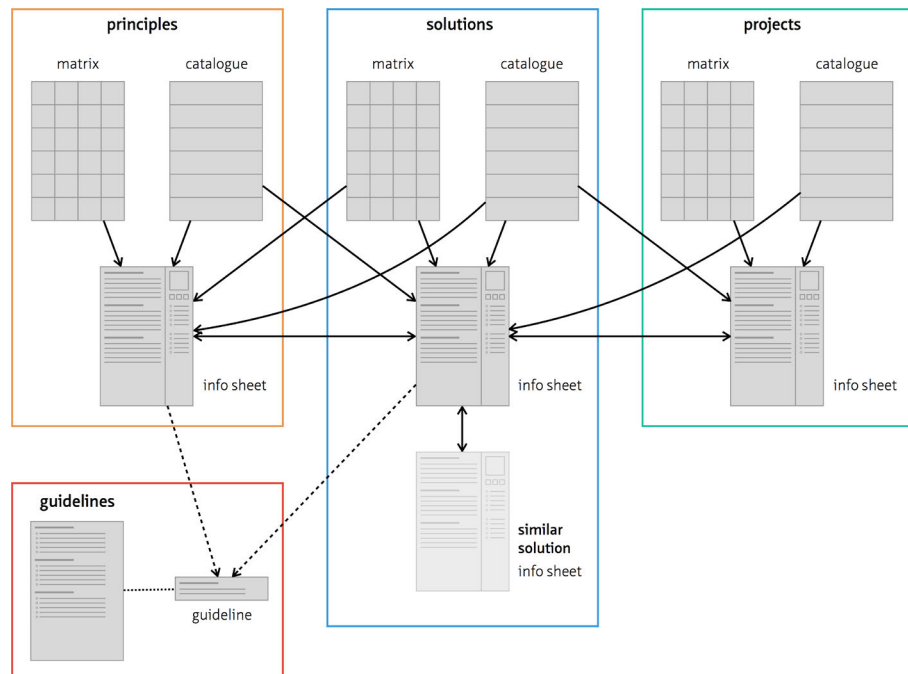

FIGURE 8.3 Scheme of custom navigation patterns.

In section 7.3 it was analysed that the concept tool conforms to a large extent to the stated requirements, with the exception of requirements #12 on offering customisation options. In addition, several architects were asked to use the tool for some time during their practice. They were introduced to the tool in a 45 minute one-on-one session and asked to use the tool sometimes during the successive weeks after which a follow-up meeting was arranged to collect their feedback. The results can be found in section 7.4. The main outcomes are summarized here:

- The general opinion about the added value of having information on climate-responsive design in the early phases of the design process is acknowledged by all respondents.
- It was mentioned that the availability of the information may increase the chance on a integral design outcome, rather than seemingly employing design solutions as add-ons to the design.
- The added value of climate-responsive design in the evaluation and implementation phase is acknowledged as well, but only if the information is made more specific and quantified on relevant aspects, including energy performance, costs and pay-back time.
- The possibility of comparing different design solutions - in an easy to read visual style - is considered fundamental in the evaluation stage.
- The presented overviews in matrix form were identified as a valuable element of the tool.
- The guidelines in their present form were mentioned as a less valuable element of the tool, since they were hidden and could hardly be used during decision support. It was mentioned that the guidelines would benefit more from a presentation in the form of a roadmap.
- The bookmarks in their current form were considered as less valuable, but could benefit from adding the possibility of only bookmarking selective parts of the presented information.
- A more visible presentation of combined design solutions was identified as a valuable but yet missing element of the tool.
- It was mentioned that a more concentrated comparative analysis among selected design solutions is considered vital for the tool to become more helpful as design-decision support.
- It was mentioned that the offered information forces the architect to think ahead. However, it was also mentioned that the presented information is not per se directive or defining in the design process, which could be improved by offering more deepened and stratified information in the form of schemes and drawings.
- It was mentioned that the tool has potential to be used as a communication tool when presenting design ideas to clients. On the condition that the knowledge base is expanded with more illustrative examples in photos, schemes and drawings.
- The tool in general was considered user-friendly since it is organised, well structured and has a recognisable visual style. Downside of the tool is that the descriptive information is often presented in bulk. This would be improved when presented

as an enumeration where possible. Furthermore, it was acknowledged that the usability of the tool will benefit from the use of filters that limit the presented information only relevant to the design task ahead and a more layered presentation of detailed information.

The following suggestions for future development of the tool are identified:

- The presentation of knowledge using different layers of detail, by starting to provide a concise overview (e.g. guidelines, synergetic and conflicting effects and applicability) and giving the user access to more specific content (e.g. background information and properties) on demand.
- A more prominent, direct and visual approach to synergetic and conflicting effects.
- A more streamlined presentation of primary and related secondary content on the info sheets.
- The extension of projects with more detailed information, schemes, drawings, performance and lessons learned, by linking to existing (online) resources.
- The implementation of more context-specific content (e.g. building type, scale, setting) in order to speed up the process of developing an energy concept and improve the outcome.
- The introduction of filters for setting project-specific conditions (e.g. plot size, orientation, maximum building height) in order to limit the amount of information presented only to the relevant bits.
- A more concentrated and visual approach for the comparison of different design solutions.
- A more selective approach to the bookmarks in order to limit the amount of bookmarked information only to the relevant bits.
- The widening of the scope of the knowledge base with the inclusion of more dedicated knowledge of the urban microclimate and its effects on natural energy potential of the built environment.
- It is essential to keep the knowledge base up to date. This is probably best outsourced to a knowledge institute or a dedicated organisation with expert contributions.

Main research question

How can architects fully exploit the potential of natural energy sources within the built environment in their process of designing comfortable low-energy dwellings using climate-responsive building elements?

In order for architects to successfully implement climate-responsive design they need to understand the potential of the natural sources within the built environment and how the building's space and mass can harvest and harness these energy flows. Rather than trying to make the designer think like an engineer and use the tools of an engineer, it is better to transform the knowledge to the field of the architect.

Many design choices made in the early stages of the design process determine the possibility of the applicability of climate-responsive design solutions. In this phase of the design process the architect needs to be steered in directions where the use of climate-responsive design will become beneficial by presenting design guidelines and design alternatives, rather than given insight in absolute performance of different design options. The generation of absolute performance in this state will take too much time in the process of design iteration. Architect's will benefit here from working concepts, indications of their performance, constraints of application, an overview of conflicting and synergetic effects when applied together with other design solutions and the impact of it on the visual appearance of design.

A working concept for a support tool was developed within this research project. The aim of the tool is to support the architect in the generation of design options for the energy concept of their design. Using a web-based support tool, architect's can access relevant knowledge in different ways that suit their method of working. It also enables the presentation of relationships in a clear way and therefore unlocks much broader parts of the content to them. It will help speeding up the proces of design iteration before the energy concept can be assessed into more depth in the successive phase of the design process.

§ 8.2 Reflections and recommendations

This research resulted in a working concept of a climate-responsive design-decision support tool. The tool provides a translation and transformation of expert knowledge on climate-responsive design into the field of the architect. As with any tool that contains expert knowledge, the presented information is subject to interpretation and can be misread. By no means the presented information can be without error or argument. Therefore, the use of such expert tools does not campaign for not consulting experts. On the contrary, expert opinion validate the choices made by the architect. The tool is meant to give informative support to the architect during the early stages of designing the energy concept.

While conducting the research many lessons were learned. By answering the research questions, it becomes evident where there is room for improvement. These findings are presented here as recommendations for further research and tool development.

Update the presentation of the context-specific knowledge and expand the knowledge base with more context-specific knowledge

Since hardly any design project starts with a *carte blanche*, presenting only relevant knowledge will enable a head start in the design process. This has been identified with the functional requirements (section 7.1) and pinpointed by the architects that reviewed the tool. However, the presentation of context-specific knowledge within the tool in its discussed form falls short at this aspect, since the knowledge is often scattered around. Here lies room for improvement.

One way to improve this is by using labels to tag bits of knowledge and make these labels available to the user as filters. This includes labels such as building scale (e.g. detached houses, row houses, high-rise, etc.) and setting (e.g. urban, rural, etc.), among others. These labels - especially the ability to filter on labels - will enable the architect to navigate more quickly to relevant parts of the knowledge and will decrease the number of design iterations in the process of developing an energy concept.

Expand the knowledge base with knowledge layers

The knowledge is now presented in bulk and can become too much to handle. The bundling and filtering of context-specific knowledge is one way to make the knowledge more accessible. Another way is to implement knowledge layers in which the presented level of detail is gradually expanded from general to practical. The use of the general knowledge layer is used to grasp the concept of a design principle or solution and to quickly assess if it has potential to be used in the architect's design task. The practical level or levels then give more insight into the applicability and its performance, by for example the presentation of project examples with detailed drawings, an overview of applied materials, and the listing of specific design considerations. In addition, the most detailed practical knowledge layer can also be extended with more specific and directive guidelines.

Development of indicators of performance of design solutions

In the research process multiple attempts were made to derive general quantifications on the comfort and energy performance of climate-responsive design solutions. The idea was to come up with some kind of indicators to allow a quick-scan of the performance of a certain design solution in comparison to alternatives. It turned out that quantifications of comfort contribution and energy performance on a single solution basis are difficult to make generic, since they are influenced by many design parameters.

Therefore, such quantifications can hardly be employed to assess different design solutions during the development of the energy concept for the purpose of selecting one solution in favour of another. Simply because there are too many design variables at that time in the process that affect performance. However, architects would be much helped by such indicators and the development of them would be very helpful.

When the tool is expanded with filterable context-specific knowledge and the knowledge layers, performance indicators can become meaningful since they can be presented at the more practical layers.

Insight in possible disagreements between the employment of the energy function of (climate-responsive) building elements and their primary function

In this research a list has been presented of possible energy functions of building elements, alongside their primary function. In some cases these energy functions may interfere with their primary function. Complementary research is needed to pinpoint these disagreements and to develop guidelines to overcome them.

Call for context-specific energy potential studies

A study into the influence of certain urban and building design parameters, namely street width and orientation, and roof shape and envelope design, on the solar exposure of the urban canyon and the feasibility of passive solar heating strategies in dwellings (Looman & Van Esch, 2010; Van Esch et al., 2012) has shown that typical passive solar design solutions such as enlarged transparent openings not automatically lead to improved performance. In fact, some studied configurations show a clear worsening.

It is a common mistake to present the natural energy potential as if the building is to be found in an open field with unfettered views to the horizon. By doing so a deviant image of the real natural energy potential is taken into account during the design process which may lead to wrong design decisions and, even worse, the false conclusion that comfort demands can never be met by employing naturally occurring energy forces.

In conclusion, the setting of a proposed building plot should always be taken into account when calculating the energy potential. Even better, the generation of an extensive map of the energy potential of a given plot prior to the architect starting with his or her process will provide a much more realistic image of context-specific analytical guidelines.

Consideration of urban microclimate in the design of buildings

In supplement to the prior recommendation it is to be expected that new building developments will also affect the urban microclimate that they reside in. These alterations on the urban microclimate should also be mapped in advance of construction and should be part of the assessment. Preferably, new developments should impact the urban microclimate in favourable ways.

§ 8.3 Outlook

The step-by-step approach to prescribe more stringent standards on energy performance predominantly steers towards developments in the technical direction towards the widespread adoption of least-cost³³, sub-optimised existing solutions. Even the newly proposed indicators (Rijksdienst voor Ondernemend Nederland, 2015) lack a certain ambition. In line with the European requirements (European Council for an Energy Efficient Economy, 2010) all new buildings need to be near energy neutral by the end of 2020. For the Dutch case, instead of a single performance indicator, three indicators now have to be met:

- 1 maximum energy demand in kWh/m²a
- 2 maximum primary energy use in kWh/m²a
- 3 minimum share of renewable energy in %

Regarding the third indicator, preliminary demands for the minimum share of renewable are set to 50% (Haytink, 2015), which means so much that the other half can still be met using non-renewable sources. This is already a dead end now, and will certainly be in 2021. Both current and proposed future standards hardly trigger true innovation on the architectural or even contextual level, the fundamental levels in the field of low-energy building design.

This has to change and a fair way to do this might be by taking life cycle costs - running costs, and the costs of environmental and health impact - into account during assessment. Altogether, more knowledge on sustainable building design, and in particular the transformation and transfer of that knowledge to the design practice, is essential. The creation of design-decision support tools can assist in a more widespread implementation of such knowledge. These tools also have much potential as teaching tools in architecture education.

As a final remark, in order to create true climate-responsive indoor environments the outdoor environment has to be considered in a mutual way. The indoor and outdoor climate interact. The urban microclimate is steering the energy potential and gives direction to the creation of comfortable indoor environments, but the building itself also affects the microclimate it sets in. Understanding both domains and designing accordingly will be profitable to both. This is a direction in which building design needs to evolve.

References

- European Council for an Energy Efficient Economy (2010) Directive 2010/31/EU of the European Parliament and the Council on the energy performance of buildings (recast). Strasbourg, France: Author.
- Haytink, T.G. (2015) Nieuwe criteria als opvolger van EPC in Bouwwereld. Retrieved from <https://www.bouwwereld.nl/bouwkennis/regelgeving-normering/nieuwe-criteria-als-opvolger-epc/>
- Looman, R.H.J. and Van Esch, M.M.E. (2010) Passive solar design – where urban and building design meet in Design and Nature V, pp. 129-138. Southampton, England: WIT Press.
- Rijksdienst voor Ondernemend Nederland (2015) Handreiking BENG - Voorlopig stappenplan berekening indicatoren Bijna Energie Neutrale Gebouwen op basis van de huidige methode NEN 7120. Roermond, The Netherlands: Author.
- Van Esch, M.M.E., Looman, R.H.J. and De Bruin-Hordijk, G.J. (2012) The effects of urban and building design parameters on solar access to the urban canyon and the potential for direct passive solar heating strategies in Energy and Buildings 47, pp. 189-200.

Appendices

Appendix A Description of reference building model used in simulations

In this appendix a reference building model is described into more detail. The model is used in the different simulations conducted within the scope of this research. The model represents a mid-terraced dwelling, the most common type in both existing stock and new housing developments in the Netherlands. The building form, plan and its roof type is based on the reference dwelling as described by SenterNovem (2006).³⁴ The chosen reference model was representative for the then current and expected standard in the Netherlands with respect to the building design, applied building services, energy performance and manufacturing costs, among others.³⁵

Drawings and floor plans

Figure App.A.1 and Figure App.A.2 show the view of the front and back façade of the model and the floor plans. The three-storey building had a total gross floor area of 124.3 m². The ground floor contains the main living area typically with an open connection to the kitchen at the front of the building. The back of the ground floor gives access to the private terrace. The first floor accommodates three bedrooms and the bathroom. The second floor is designed to be used a habitable zone as well.

-
- 34 Since 2010 SenterNovem operates under the hood of Agentschap NL (NL Agency), an agency of the Dutch Ministry of Economic Affairs that implements government policy for sustainability, innovation, and international business and cooperation. In 2014 Agentschap NL merged into the RVO, Rijksdienst voor Ondernemend Nederland (Netherlands Enterprise Agency).
- 35 The definition of the reference dwelling was updated in 2011 and again in 2015, following the more stringent requirements on energy performance (see also section 3.2.1). The form and layout of the reference dwelling didn't change. The improved energy performance was met by increased levels of insulation and the employment of building systems such as solar thermal collectors, solar cells and demand controlled ventilation with heat recovery.



FIGURE APP.A.1 Views of the front and back façade of the mid-terraced dwelling with a gable roof. The front façade contains the main entrance to the house from the public street.

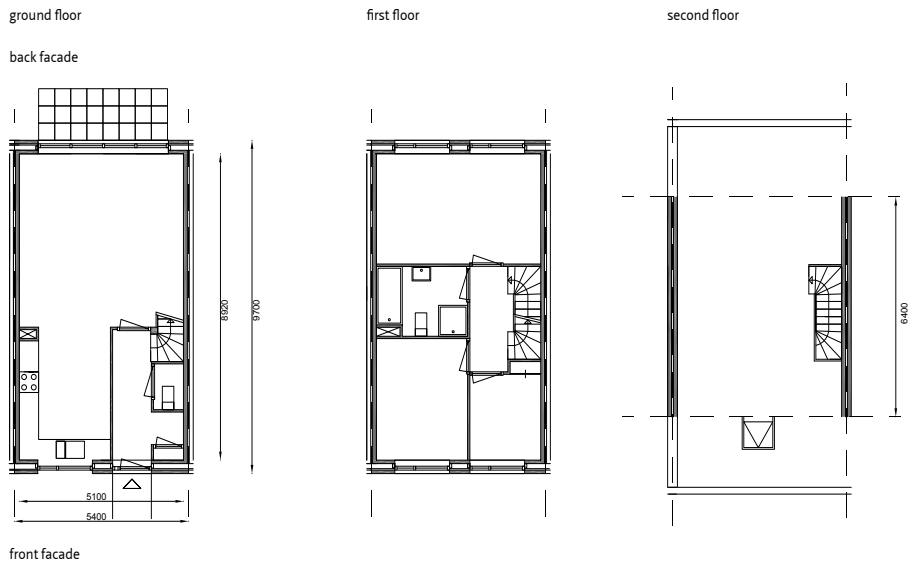

FIGURE APP.A.2 Floor plans of mid-terraced dwelling.

Materialisation

Table App.A.1 shows an overview of the building elements and their materialisation. The reference model is constructed from massive building elements that can be categorized as high thermal mass, with an overall building weight above 600 kg/m² floor area. The building meets standard insulation requirements; both ground floor and external walls have a heat resistance R_c of 3.0 m²K/W, the roof has a heat resistance R_c of 4.0 m²K/W. The floors and walls are not accommodated with any type of internal finish (e.g. carpet, wooden panels, ceramic tiles or gypsum plaster).

LAYER	Thickness d (m)	Thermal conductivity λ (W/mK)	Heat resistance R_c (m ² K/W)	Specific heat c_p (J/kgK)	Density ρ (kg/m ³)	Mass by area (kg/m ²)	Heat capacity by area (kJ/m ² K)
Ground floor	internal heat transfer	-	-	0.13	-	-	-
	Lightweight concrete	0.050	0.5	0.10	840	1350	67.5
	Heavyweight concrete	0.050	1.7	0.03	840	2400	120
	Insulation	0.120	0.045	2.67	1470	30	3.6
	external heat transfer	-	-	0.04	-	-	-
	total	0.220		3.0			191.1
Internal floor	internal heat transfer	-	-	0.13	-	-	-
	Heavyweight concrete	0.200	1.9	0.11	840	2500	500
	external heat transfer	-	-	0.13	-	-	-
	total	0.200		0.4			500.0
Internal wall	internal heat transfer	-	-	0.13	-	-	-
	Sandline brick	0.100	1	0.10	840	2000	200
	external heat transfer	-	-	0.13	-	-	-
	total	0.100		0.4			200.0
Separation wall between dwellings	internal heat transfer	-	-	0.13	-	-	-
	Heavyweight concrete	0.200	1.9	0.11	840	2500	500
	external heat transfer	-	-	0.13	-	-	-
	total	0.200		0.4			500.0

>>>

	LAYER	Thickness d (m)	Thermal conduc- tivity λ (W/ mK)	Heat re- sistance R_c (m ² K/W)	Specific heat c_p (J/kgK)	Density ρ (kg/m ³)	Mass by area (kg/ m ²)	Heat capacity by area (kJ/m ² K)
External wall	internal heat transfer	-	-	0.13	-	-	-	-
	Sand-lime brick	0.100	1	0.10	840	2000	200	168.0
	Insulation	0.090	0.035	2.57	1470	30	2.7	4.0
	Air gap	0.007	-	0.10	-	-	-	-
	Building brick	0.100	1.2	0.08	840	1900	190	159.6
	external heat transfer	-	-	0.04	-	-	-	-
	total	0.297		3.0			392.7	331.6
Roof	internal heat transfer	-	-	0.13	-	-	-	-
	Heavyweight concrete	0.200	1.9	0.11	840	2500	500	420.0
	Insulation	0.160	0.045	3.56	1470	30	4.8	7.1
	Lightweight concrete	0.100	0.5	0.20	840	1350	135	113.4
	external heat transfer	-	-	0.04	-	-	-	-
	total	0.460		4.0			639.8	540.5

TABLE APP.A.1 Overview of building elements and their materialisation.

The doors are made of wood ($\lambda = 0.12$ W/mK; $c_p = 1880$ J/kgK; $\rho = 600$ kg/m³) and are 40 mm thick. The standard window system consists of a double-glazing unit filled with argon ($U_g = 1.27$ W/m²K) and aluminium framing with a thermal break.

References

SenterNovem (2006) Referentiewoningen nieuwbouw. Sittard, The Netherlands: Author.

Appendix B Curriculum vitae



Remco Looman was born June 3rd, 1978 in Utrecht, The Netherlands. He studied Civil Engineering at Delft University of Technology and graduated in 2004, specialised in building engineering.

After graduation he started to work as a research fellow at the Faculty of Architecture and Built Environment in Delft, followed by the start of a PhD research project on climate-responsive design in 2006. During the PhD research he collaborated on the revision of the publication 'Toolkit Duurzame Woningbouw' at Cauberg-Huygen in Rotterdam and joined the international research project Annex 44.

In 2011 he founded Designlab 2902, a design and advice firm for climate, comfort and sustainable development in the built environment, together with Marjolein Pijpers-van Esch. Furthermore he is involved as a guest teacher at the faculty of Architecture and Built Environment, and in the design and development of Klimapedia, an online resource for teaching material in the fields of building physics, indoor climate, building services and sustainable design.

Appendix C List of related publications

2012

Van Esch, M. M. E., Looman, R. H. J. & Hordijk, G. J. (2012) The effects of urban and building design parameters on solar access to the urban canyon and the potential for direct passive solar heating strategies in Energy and Buildings. 47, April, p. 189-200.

2010

Looman, R. H. J. & van Esch, M. M. E. (2010) Passive solar design: where urban and building design meet, Design and nature V - Comparing design in nature with science and engineering. Carpi, A. & Brebbia, C. A. (eds.). Southampton: WIT Press, p. 129-138.

2009

Looman, R. H. J., van den Dobbelaar, A. A. J. F. & Cauberg, J. J. M. (2009) Climate-responsive design - matching supply of renewable energy sources and energy demand patterns in dwellings for improved comfort, SASBE2009 conference proceedings. van Dobbelaar, A. A. J. F. (ed.). Delft: Technische Universiteit Delft, faculteit Bouwkunde, p. 1-8.

2007

- Looman, R. H. J., Cauberg, J. J. M., van den Dobbelaar, A. A. J. F., van Timmeren, A. & Tenpierik, M. J. (2007) Climate-responsiveness of building elements, PLEA 2007 - Sun, wind and architecture - 24th International conference on passive and low energy architecture. Wittkopf, S. K. & Tan, B. K. (eds.). Singapore: National University of Singapore, department of architecture, p. 105-111.
- Hasselaar, B. L. H. & Looman, R. H. J. (2007) The climate adaptive skin, the integral solution to the conflict between comfort and energy performance, CIB World building congress, construction for development 2007. Haupt, T. C. & Milford, R. (eds.). Cape Town: International council for research and innovation in building and construction, p. 1115-1125.
- Looman, R. H. J. (2007) Design strategy for the integration of climate-responsive building elements in dwellings, CIB World building congress, construction for development 2007. Haupt, T. C. & Milford, R. (eds.). Cape Town: International council for research and innovation in building and construction, p. 1106-1114.